

MAY · 1941

PRICE 50 CENTS

McGRAW-HILL PUBLISHING CO., INC.

electronics

radio, communication, industrial applications of electron tubes . . . engineering and manufacture

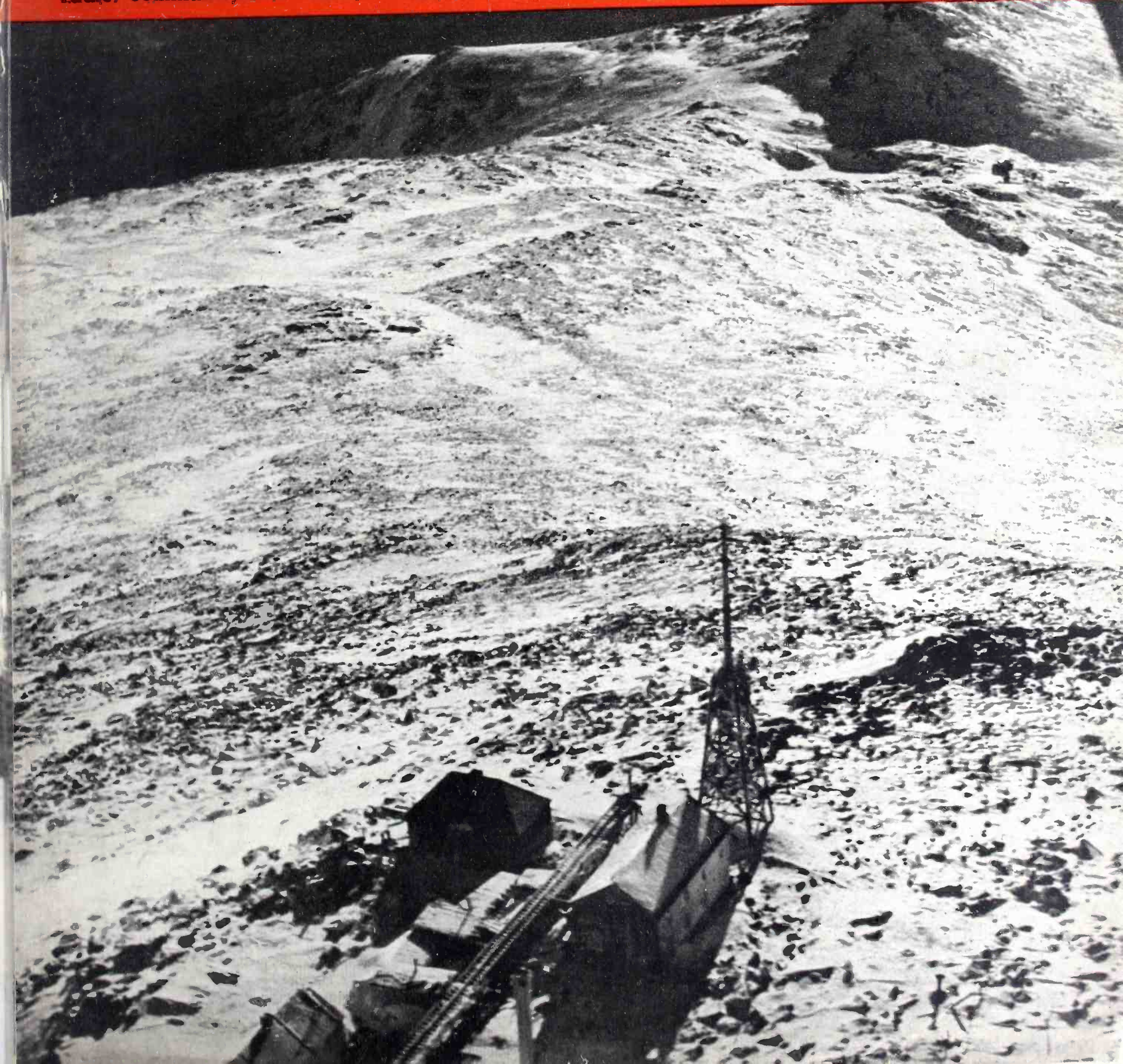

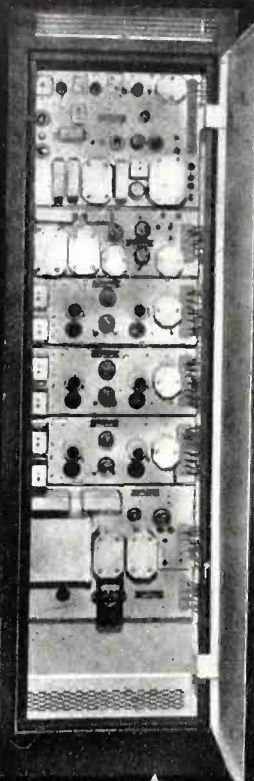

★
GENERAL
ELECTRIC

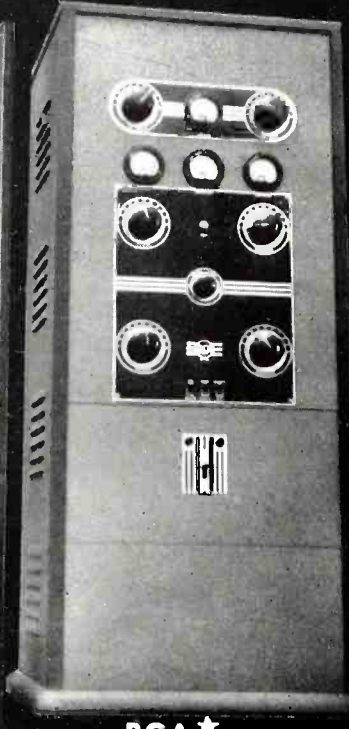

★
RCA



★
WESTINGHOUSE

★
WESTERN
ELECTRIC

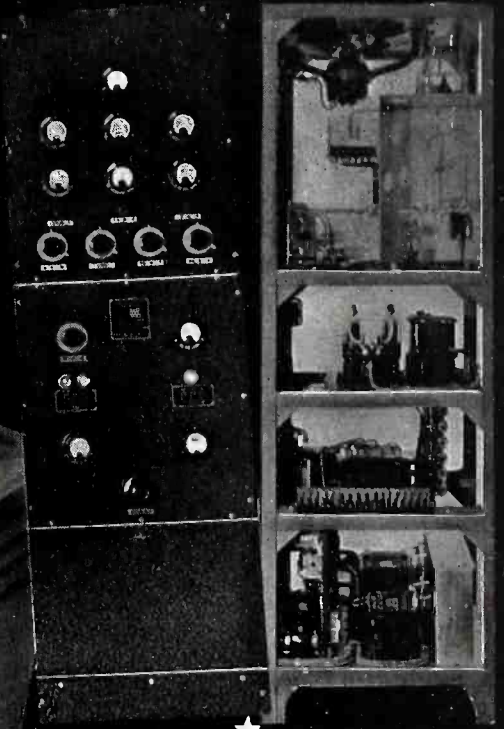

★
RADIO RECEPTOR

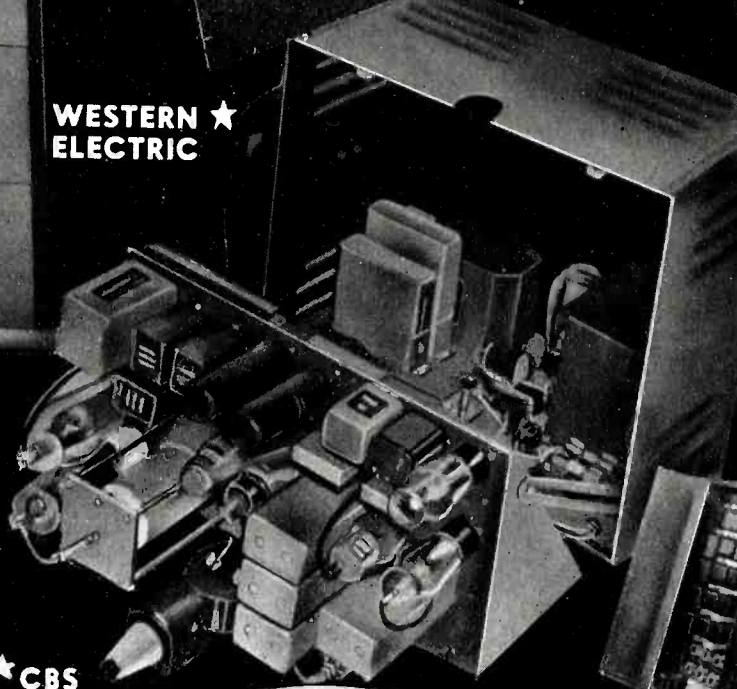

★
MARINE
COMMUNICATIONS



★
CBS

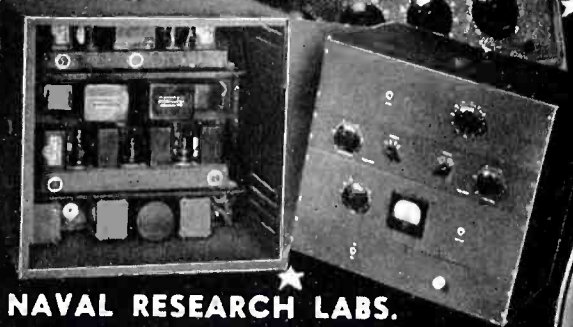

★
NAVAL RESEARCH LABS.



★
BELL TELEPHONE



★
FEDERAL TELEGRAPH CO.



★
WESTERN UNION

Recognized Quality

The quality of UTC products is well illustrated by the leaders of American industry who have chosen them for use in their equipment.

The UTC research laboratories are doing continuous research and development on special units to fit specific customers' requirements.

May we assist you on your problem?

UNITED TRANSFORMER CORP.

150 VARICK STREET ★ NEW YORK, N. Y.

EXPORT DIVISION: 100 VARICK STREET NEW YORK, N. Y. CABLES: 'ARLAB'



A McGRAW-HILL PUBLICATION

electronics

CONTENTS—MAY, 1941

KEITH HENNEY
Editor

Donald G. Fink
Managing Editor

Beverly Dudley Craig Walsh
Contributing Editor Associate Editor

M. L. Matthey J. M. Heron
Assistant Editor Assistant Editor

Harry Phillips
Art Director

H. W. MATEER
Manager

Wallace B. Blood
Sales Manager

Contents Copyright, 1941, by
McGraw-Hill Publishing Company, Inc.

McGRAW-HILL
PUBLISHING COMPANY, INC.

JAMES H. MCGRAW
Founder and Honorary Chairman

Publication Office
99-129 North Broadway, Albany, N. Y., U.S.A.
Editorial and Executive Offices
330 West 42nd St., New York, N. Y., U.S.A.

James H. McGraw, Jr., President
Howard Ehrlich, Executive Vice President
Mason Britton, Vice Chairman
B. R. Putnam, Treasurer
D. C. McGraw, Secretary
J. E. Blackburn, Jr., Director of Circulation

Cable Address:
MCGRAWHILL, New York
Member A. B. P. Member A. B. C.

W39B, MT. WASHINGTON, N. H. Cover

An airplane view of one of the first f-m stations to begin commercial operation. With a power of one kilowatt and its service area includes all of New Hampshire, and large portions of Maine and Vermont

BIG VOICE FOR HEMISPHERE DEFENSE Frontispiece

Beam antennas located at Bound Brook, N. J., directed toward Latin America

PRIORITIES AND THE RADIO INDUSTRY 21

How materials important to the radio industry are being taken over for defense and what might be done to ease the situation

F-M TRANSMITTER MEASUREMENTS—I, by H. P. Thomas 23

Methods of measuring the characteristics of f-m transmitters to insure the transmission of high quality signals

VOLTAGE MULTIPLIER RECTIFIER CIRCUITS, by D. L. Waidelich 28

Practical rectifier circuits which will deliver a d-c output voltage almost triple and quadruple the input a-c voltage

FACSIMILE SPEEDS AIR RECONNAISSANCE 30

Pictures showing how pictures are flashed from an airplane in flight to a ground station in a fraction of the time necessary to fly to the station

PUSH-BUTTON SWITCHING FOR LOW LEVEL CIRCUITS, by H. H. WOOD 32

A push-button relay switching system for small stations where the high level system is too costly

EXPERIMENTAL DUO-PENTODE, by Maxwell K. Goldstein 34

Two pentodes are built within one envelope. The shielding is such that they are capable of cascade operation at radio frequencies without interference

30- TO 340-MC WAVEMETER, by E. L. Hall 37

A precision instrument of great sensitivity for use in the ultrahigh frequencies

AUDIO AND VIDEO SIGNALS ON A SINGLE CARRIER, by Heinz E. Kallmann 39

Audio and video signals are each transmitted part of the time, the audio during the timing pulses of television signal. Theoretically the audio range goes up to 7875 cps for a 525-line, 30-frame picture

ELECTRON TUBES IN PETROLEUM RESEARCH—II, by C. J. Penther and D. J. Pompeo 43

Tube circuits serve in the search for more facts concerning petroleum

A RECORD PATTERN-WIDTH RULER, by Don R. King 47

A ruler on which the diffraction pattern of a record is read directly in decibels above or below a standard level

DEPARTMENTS

CROSSTALK	19	NEW BOOKS	78
REFERENCE SHEET	47	THE ELECTRON ART	83
TUBES AT WORK	48	THE INDUSTRY IN REVIEW	94
TUBES	69	INDEX TO ADVERTISERS	105

ELECTRONICS, May, 1941, Vol. 14, No. 5. Published monthly, price 50c a copy. Allow at least ten days for change of address. All communications about subscriptions should be addressed to the Director of Circulation, 330 West 42nd Street, New York, N. Y.

Subscription rates—United States and possessions, Mexico, Central and South American countries, \$5.00 a year, \$8.00 for two years, \$10.00 for three years. Canada (Canadian funds accepted), \$5.50 a year, \$9.00 for two years, \$11.00 for three years. Great Britain and British Possessions 36 shillings for one year, 72 shillings for three years. All other countries \$6.00 for one year, \$12.00 for three years. Entered as Second Class matter, August 29, 1936, at Post Office, Albany, New York, under the Act of March 3, 1879. BRANCH OFFICES: 520 North Michigan Avenue, Chicago; 68 Post Street, San Francisco; Aldwych House, Aldwych, London, W.C. 2; Washington; Philadelphia; Cleveland; Detroit; St. Louis; Boston; Atlanta, Ga.

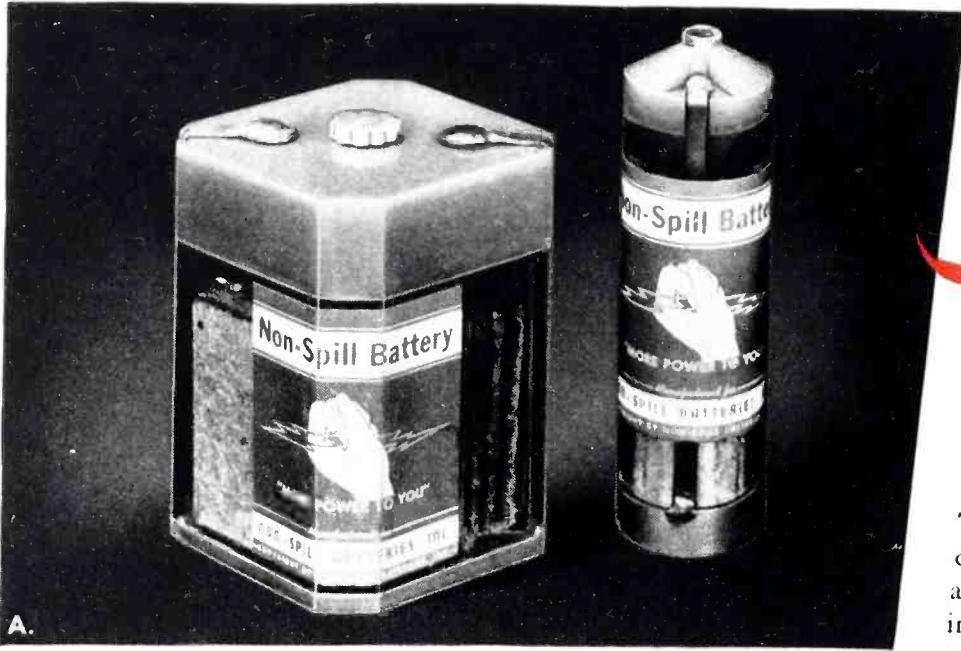

A.



B.

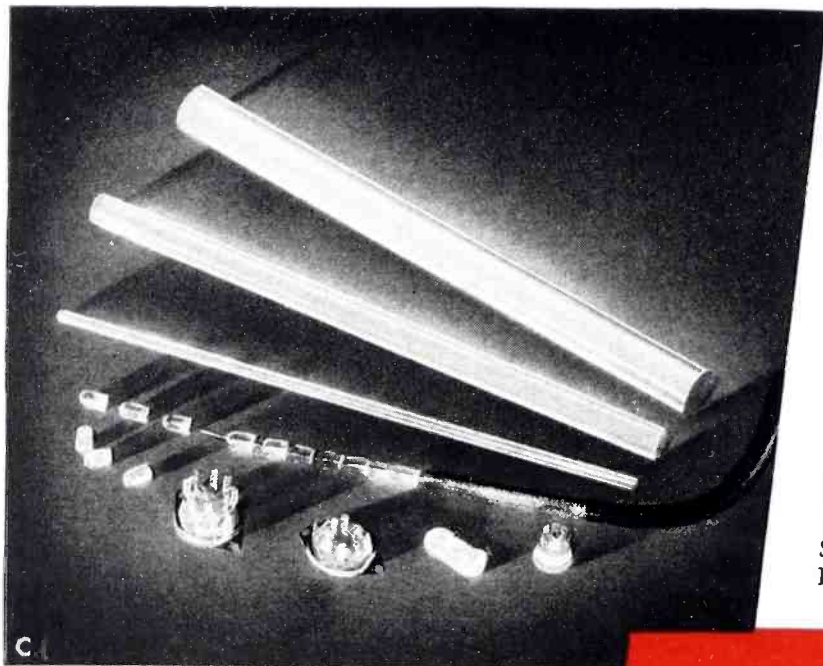

C.

A. Lustron case for Non-Spill Batteries molded by Universal Plastics Corp., New Brunswick, N. J.

B. Acousticon Hearing Aid with Koehler batteries in Lustron case molded by American Insulator Corp., New Freedom, Pa.

C. Lustron-insulated coaxial cable and communication set parts by American Phenolic Corp., Chicago, Illinois.

**SPEED PRODUCTION
CUT COSTS
STEP UP SALES**

WITH

Lustron

This may sound like magic in these days of raw material priorities, tool and die bottlenecks, and fast-changing markets. But it's a fact—many manufacturers in many widely varied industries have speeded up production, cut down costs, and stepped up the sales appeal of their products by capitalizing on one or more of versatile Lustron's special advantages!

Often, as with these battery housings (A and B), which must withstand prolonged contact with sulphuric acid, Lustron's high resistance to acids and alkalies is important. Again the high dielectric strength and unusual insulating properties which won Lustron its assignment in these communication set parts and Lustron-insulated coaxial cable, (C) are a prime consideration.

Whatever the particular application, however, the ease with which complicated parts or finished products are "one shot" injection molded of Lustron almost invariably results in production savings of both time and money... while Lustron's limitless color range and smooth, lustrous finish add new eye appeal, an important factor in any product's buy appeal.

It's quite likely that Lustron can help you find a new way to meet today's new sales and production problems. For a full description of this versatile plastic's many advantages, and a list of capable molders, inquire: MONSANTO CHEMICAL COMPANY, Plastics Division Springfield, Massachusetts. District Offices: New York, Chicago, Detroit, St. Louis, Birmingham, San Francisco, Los Angeles, Montreal.

MONSANTO PLASTICS
SERVING INDUSTRY... WHICH SERVES MANKIND

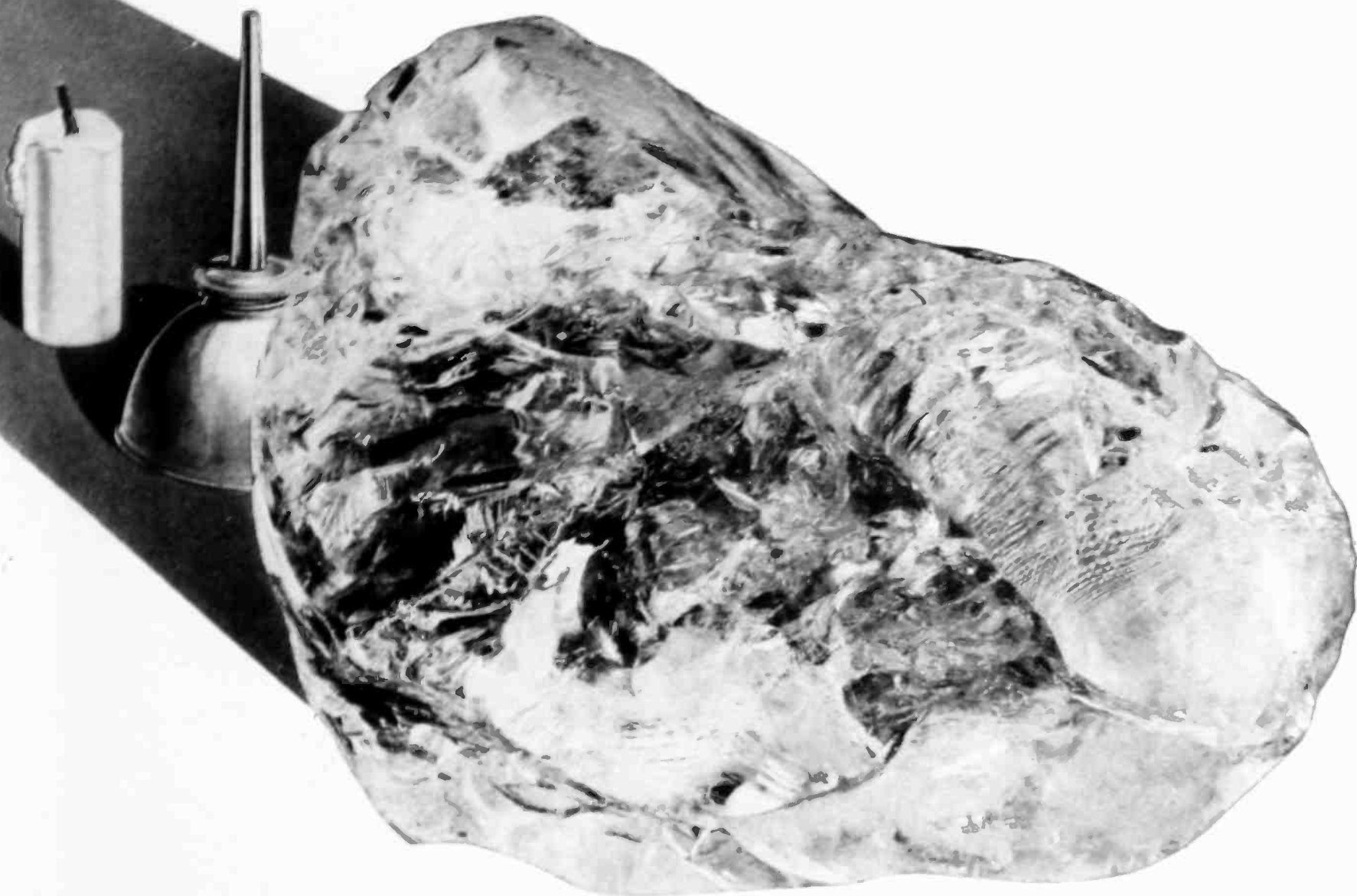

This permanent tracing paper is transparentized with *Albanite*

No oil, no wax—but a remarkable new transparentizing agent developed in the K&E laboratories—produces this truly permanent tracing paper! ALBANENE is made of 100% long fiber pure white rags—treated with *Albanite*—a new crystal clear synthetic solid, physically and chemically inert. ALBANENE will not oxidize, become brittle or lose transparency with age.

Equally important, ALBANENE has a fine hard "tooth" that takes ink or pencil beautifully and erases with ease . . . a high degree of transparency that makes tracing simple and produces strong sharp blueprints . . .

extra strength to stand up under constant corrections, filing and rough handling. ALBANENE has *all* the working qualities you've always wanted—and *it will retain all these characteristics indefinitely.*

Make ALBANENE "prove it" on your own drawing board. Ask your K&E dealer or write us for an illustrated brochure and generous working sample.

EST. 1867

KEUFFEL & ESSER CO.

NEW YORK — MORRIS, N. J.

CHICAGO · ST. LOUIS · SAN FRANCISCO · LOS ANGELES · DETROIT · MONTREAL



MINERAL OIL. Most tracing papers are treated with some kind of oil. Mineral oil is physically unstable, tends to "delf", never dries completely. Papers treated with mineral oil pick up dust, lose transparency with age.



VEGETABLE OIL. Chemically unstable, oxidizes easily. Papers treated with vegetable oil become rancid and brittle, turn yellow and opaque with age.



ALBANITE is a crystal-clear synthetic solid, free from oil and wax, physically and chemically inert. Because of this new stabilized transparentizing agent Albanene is unaffected by harsh climates—will not oxidize with age, become brittle or lose transparency.

K&E

Albanene

THE STABILIZED TRACING PAPER



SAFE TO ADMIT to your Assembly Dep't!



Guarantee OF HIGHEST QUALITY
 To assure satisfactory performance, Parker-Kalon Fastening Devices are made to exacting specifications covering dimensional and physical characteristics which are checked at every stage of manufacture, and passed upon by Parker-Kalon's Quality-Control Laboratory. Should this product prove faulty in any way, replacement will be made without charge.
PARKER-KALON CORPORATION
 NEW YORK, N. Y., U. S. A.

Trouble-making "doubtful screws" can't get this "pass" from the Parker-Kalon Quality-Control Laboratory

COSTS NO MORE to get this Parker-Kalon Quality-Control Guarantee with every box of . . .



Hardened Self-tapping Screws
Types, sizes, head-styles for every assembly of metal or plastics



Cold-forged Socket Screws
Cap Screws, Set Screws, Stripper Bolts made to a new high standard of quality



Wing Nuts-Cap Nuts-Thumb Screws
Cold-forged . . . Neater, Stronger

With competition and defense requirements pressing you to *make it better and FASTER*, your assembly department just can't afford to admit "doubtful screws" - screws that *look* right but some of which don't work right. You need to be sure that **EVERY** Screw you buy will go in easily and hold securely. For only a few bad ones can slow up assembly work, boost costs and lead to rejected parts in a way hard to believe.

When you use Parker-Kalon, you are free from worry about "doubtful screws". They are barred from your assemblies by Parker-Kalon's famed Quality-Control Laboratory whose unique test-and-inspection routine assures you of physical and mechanical characteristics so essential to unflinching screw performance. Over 50,000 users can attest to the truth of these statements. Parker-Kalon Corp., 192-194 Varick St., New York.

SOLD ONLY THROUGH RECOGNIZED DISTRIBUTORS

Quality-Controlled **PARKER-KALON Fastening Devices**

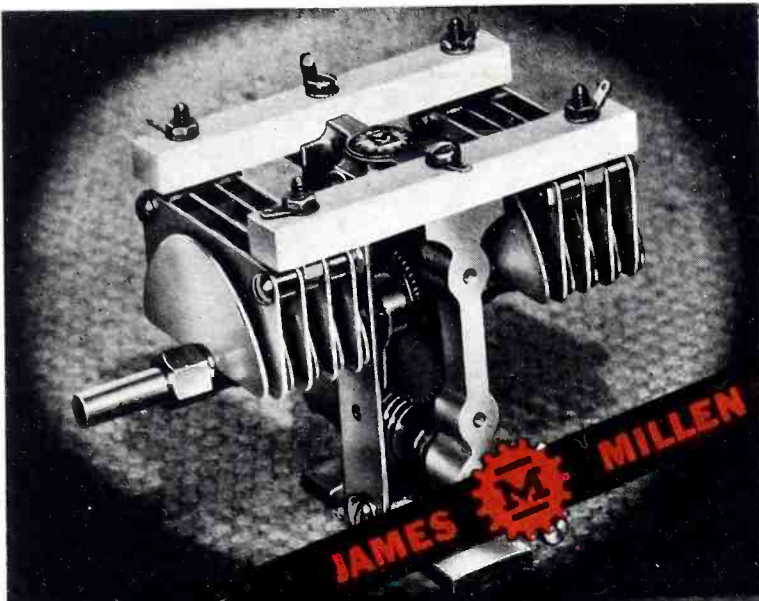

JAMES MILLEN

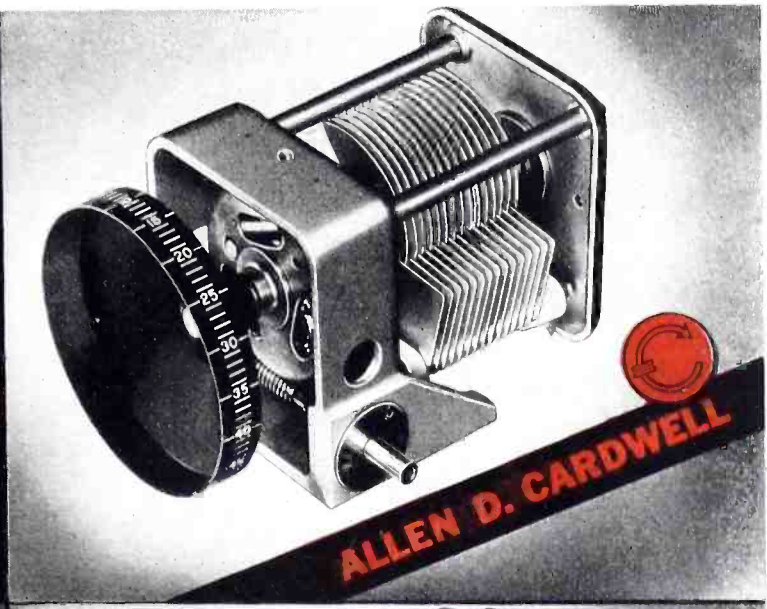

ALLEN D. CARDWELL

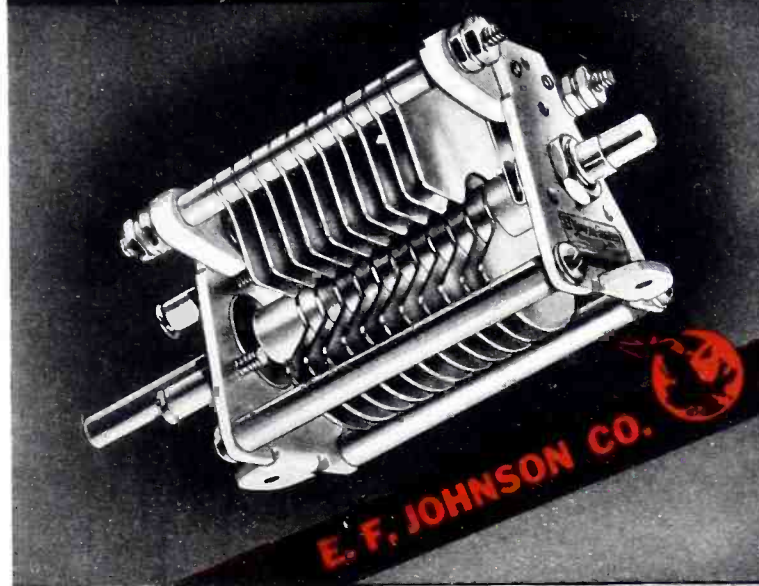

E. F. JOHNSON CO.



NATIONAL

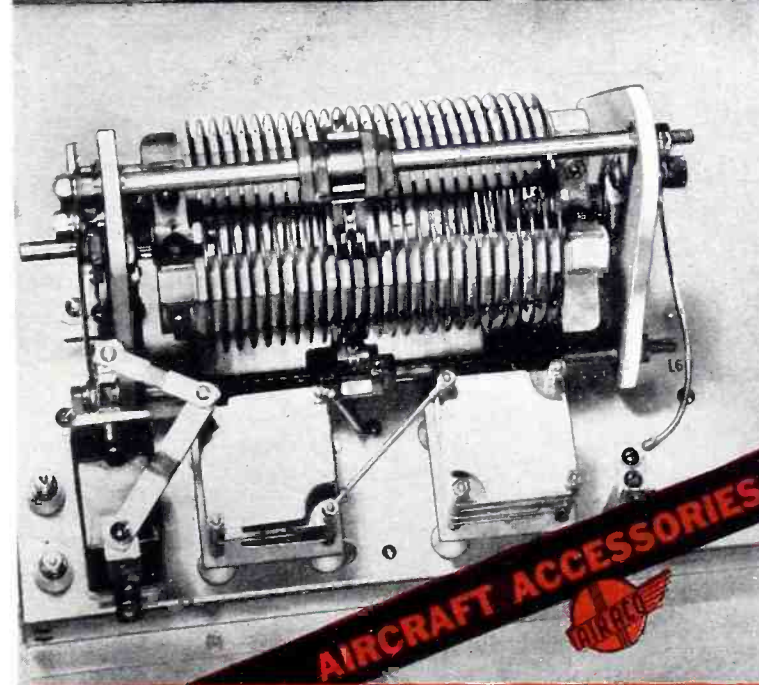

AIRCRAFT ACCESSORIES

*Why did these Manufacturers
choose **ALSiMAG** for
Condenser Insulation?*

Because condensers that are mounted on ALSiMag will remain positively aligned due to ALSiMag's absolute and permanent rigidity. Because ALSiMag's exceptionally low dielectric loss under all atmospheric conditions and its high mechanical strength make it the ideal insulator for these applications. Of course, ALSiMag 196 falls within Specifications G of the Army and Navy.

For obvious reasons, none of the many "defense" applications of ALSiMag are illustrated.

RADIO CONDENSER CO.

ALSiMAG

Trade Mark Reg. U.S. Pat. Off.

FROM CERAMIC HEADQUARTERS

AMERICAN LAVA CORPORATION • CHATTANOOGA • TENNESSEE
CHICAGO • CLEVELAND • NEW YORK • ST. LOUIS • LOS ANGELES • SAN FRANCISCO • BOSTON • PHILADELPHIA • WASHINGTON, D. C.

Compare

**THESE TWO
Motorola
F-M FEATURES
WITH THOSE OF
F-M EQUIPMENT
YOU KNOW!**

NO. 1

MAINTENANCE OF RELIABLE COMMUNICATION UNDER EXTREMELY ADVERSE CONDITIONS

Full advantage of F-M characteristics can be realized only by the use of gains in the receiver greatly in excess of gains usually employed for A-M reception. The total gain in Motorola's Emergency Service F-M Receiver exceeds 3,000,000,000 and this amplification makes possible effective limiting action with signal input as low as .1 microvolt.

Figure (A) shows noise reduction results from a carrier input to receiver. A .4 microvolt quieting signal will reduce the noise 20 decibels or to one-tenth of the level of noise measured without the signal.

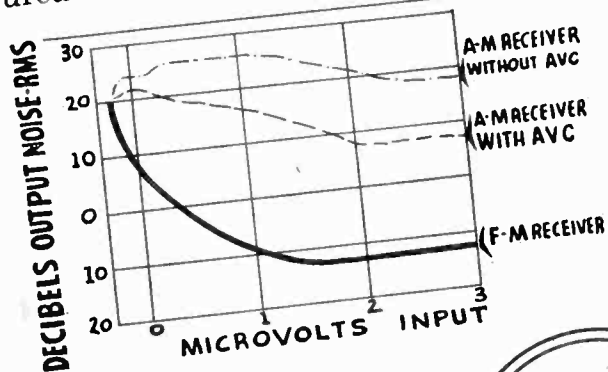

Figure A. Noise reduction in Motorola F-M Emergency Receiver in presence of laboratory noises with varying signal input, compared with A-M receivers.

NO. 2

MOTOROLA'S SQUELCH OR AUTOMATIC CARRIER- OFF NOISE SUPPRESSOR

A new principle of squelch control (pat. applied for) has been introduced into Motorola F-M equipment. This squelch which utilizes a differential voltage action is characterized by its remarkable discrimination against noise voltages. A variable control knob provides squelch control at the operator's position so that the squelch may be adjusted to open at input voltages which will be determined by local requirements to lie within the range of 0.1 to 3 microvolts. The squelch remains closed despite the generation of high voltage noise interference by trolleys, trucks and busses but responds instantly to low level carrier signals.

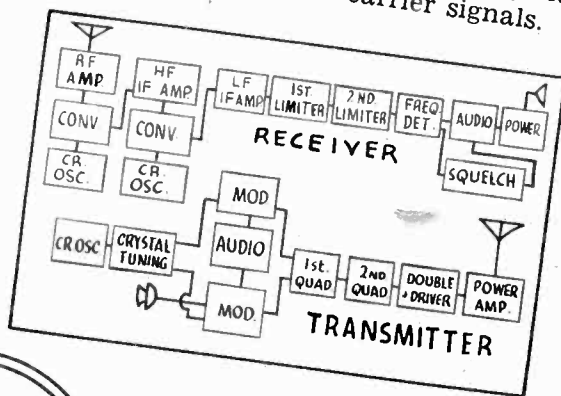
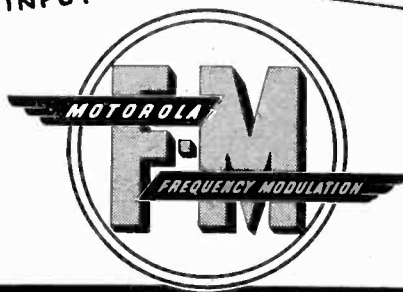

Figure B. Shown above is a block diagram of the Motorola F-M Emergency Service System.



WRITE FOR COMPLETE DESCRIPTIVE LITERATURE AND TECHNICAL DATA
GALVIN MFG. CORPORATION ★ CHICAGO, ILL.
MAKERS OF THE FAMOUS MOTOROLA AUTO AND HOME RADIOS

Stratoliners carry Capacitor Life Insurance



THERE'S EXTRA PROTECTION IN LONGER LASTING C-D CAPACITORS

Aloft in the sub-stratosphere is a long way from home. Flight, lives, record . . . everything depends on the performance of radio equipment. That is why Cornell-Dubilier capacitors are standard equipment with Transcontinental & Western Air Inc.

Over 8,000 in the flying fleet of Stratoliners and Skychiefs . . . another 4,000 C-Ds in service in the vast TWA ground station radio network. For your own protection, specify the capacitor America's leading airlines choose—Cornell-Dubilier.

CAPACITORS MAY LOOK ALIKE BUT . . . *There is extra long life, extra uniformity and*

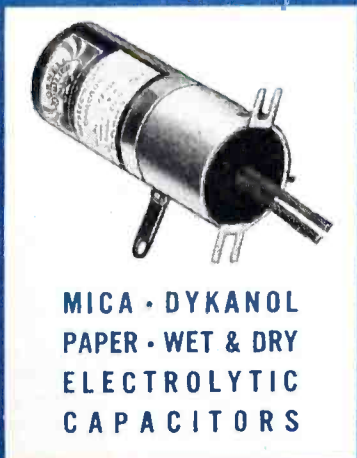

**MICA • DYKANOL
PAPER • WET & DRY
ELECTROLYTIC
CAPACITORS**

dependability built into C-Ds. Next time you specify capacitors look for the Cornell-Dubilier seal of experienced engineering. And get the hidden extras at no extra cost. Send for Catalog, Cornell-Dubilier Electric Corporation, Hamilton Blvd., South Plainfield, New Jersey.

Cornell Dubilier



SOUTH PLAINFIELD, N. J.

NEW BEDFORD, MASS.

. . . more in use today than any other make . . .

Growing FM Acceptance

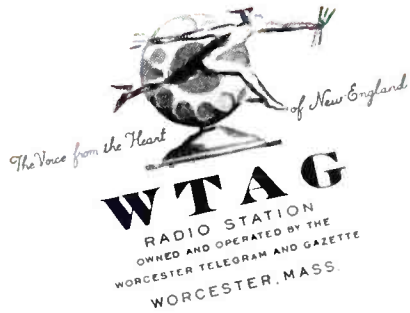

March 12, 1941

Mr. W. R. David
Radio and Television Department
General Electric Company
Schenectady, N. Y.

Dear Mr. David:

The one kilowatt General Electric frequency modulated transmitter at W1XTG has now completed its first nine months of service, and we wish to congratulate you on the success attained in its use.

The circumstances have provided an ideal opportunity to judge the performance of your equipment. In this region where FM had its initial introduction as a regular full time service to the public, the interest is keen, the audience critical, and there is ample opportunity for comparison with other FM as well as AM services. A 16 hour a day program schedule has been maintained during the above period by W1XTG.

The results have exceeded expectations. Listener comment on the quality of reproduction has been most favorable. Maintenance of the initially fine operating characteristics, and the general operating record of the transmitter have been very good indeed.

We feel that the excellent performance of your transmitter has done much to aid the growing public acceptance of FM in New England.

Very truly yours,

H. H. Newell
H. H. Newell
Chief Engineer
WTAG - W1XTG

HHN:A

with
G-E
Simplified
Circuit
Design

FM'S toughest job is audience building. And the trend in W1XTG's area shows that G-E simplified FM is doing more than its share in winning listener approval.

General Electric FM broadcast transmitters give full fidelity, real dependability, extra economy. Ask to see the figures on G-E performance.

G.E. for Complete Service

General Electric offers the only complete line in FM today—broadcast and relay transmitters, tubes, receivers, antennas, crystals, and the new station monitor. Speech equipment will be announced soon.

FM audience building is a specialty with G.E., through co-ordination of the work of our receiver and transmitter sales divisions.

Get an early start in FM. Your copy of "How to Plan an FM Station," and full information on the G-E complete service, are available through any of our 80 offices, or from Radio and Television Dept., General Electric, Schenectady, N. Y.



Chief Engineer H. H. Newell (right) compliments G.E.'s S. H. Magruder on the excellent life of the G-E tubes at W1XTG. A complete set of tubes for W1XTG's 1-kw G-E transmitter costs less than \$290!

FOR TOP PERFORMANCE
Use G-E Transmitting Tubes

GENERAL ELECTRIC



The Moth that Shuns the Flame



SYNTHANE

- A. Turned and milled Pump Valve.
 B. Sawed, shaved, milled and drilled Cabin Roller Filler for Airplanes.

NIGHT MANEUVERS! An old game with a new twist. The motorized moth, instead of fluttering into destruction, spins and loops to dodge the search from below. ● Synthane does its bit on offense and defense. Insulation for airport beacons . . for giant searchlight. Synthane protects circuits of aircraft radio and direction

finding instruments. Light weight and great strength make it desirable for a wide variety of structural airplane parts. ● Aviation is only one of Synthane's fields. Synthane is ever on the lookout for new applications, and is ready to the best of its ability to help improve products and save money. SYNTHANE CORPORATION, OAKS, PENNA.

SYNTHANE
Bakelite — laminated

TECHNICAL PLASTICS

SHEETS • RODS • TUBES • FABRICATED PARTS • SILENT STABILIZED GEAR MATERIAL



A FEW USES FOR **SYNTHANE** IN THE MANY INDUSTRIES IT SERVES

RADIO

Bushings	Switch Insulation
Broadcast Panels	Terminal Strips
Coil Forms	Tone Control Insulation
Electrolytic Condenser Washers	Trimmer Condenser Bases
Jack Spacers	Tube Socket Bases
Loud Speaker Cones	Variable Condenser Insulators
Mounting Panels	Volume Control Insulators
Plug Bases	Washers

TRANSPORTATION: AUTOMOTIVE, MARINE, RAIL AND AERONAUTICAL

Cable Guides	Pulleys
Carburetor Flutter Valves	Railway Signal Insulation
Distributor Breaker Arms and Insulators	Seal Strips
Fairleads	Shims
Instruction Panels	Starting, Lighting and Ignition Insulation
Instrument Panels	Stern Tube Bearings
Marine Pump Valve Discs	Support Blocks
Outboard Motor Pivot Bearing Bushings	Water Pump Seal Washers

ELECTRICAL POWER EQUIPMENT, STRUCTURAL INSULATION FOR:

Bus Bars	Motors
Circuit Breakers	Relays
Coils	Switches
Condensers	Switchboards
Controllers	Switch-Gear Apparatus
Fuses	Transformers
Generators	

ELECTRICAL APPLIANCES

Electric Razor Insulators	Sewing Machine Gears and Insulators
Electro-Therapeutic Equipment	Vacuum Cleaner Extension Handles
Food Mixer Gears	Washing Machine Gears and Cams
Permanent Wave Machine Parts	X-Ray Insulators
Radio Insulation	

RAYON AND TEXTILE INDUSTRIES

Bobbin Heads and Barrels	Stocking Examiner Forms
Guide Strips and Arms	Twister Balloon Separators
Rayon Processing Equipment	Verge Strips
Roll Tires and Covers	Welt Rods

MECHANICAL EQUIPMENT

Bearings	Knobs
Cams	Pulleys
Clutches	Pump and Compressor Parts
Gears and Pinions	Thrust Washers
Guide Rolls	Truck Wheels
Handles	

CHEMICAL AND METAL FINISHING INDUSTRIES

Anodizing Baskets	Pipe Fittings
Film Developing Equipment	Plating Barrels
Filter Plates	Plating Racks
Pickling & Finishing Rolls & Tank Insulators	Plating Tank Baffles & Liners
Piping	Roll Covers
	Synthetic Yarn Equipment

PETROLEUM INDUSTRY

Balls for Valves	Pipe and Fittings
Blasting Cap Containers	Piston Rings
Explosives Containers for Well Shooting	Refinery Equipment
Geophysical Instruments	Valve Discs and Rings

SYNTHANE
Bakelite —  laminated

SYNTHANE CORPORATION, OAKS, PA.

1126A AMPLIFIER HITS NEW PEAK IN CONTROL



1. STOP SPLASH or short-interval adjacent channel interference from overmodulation of your AM transmitter.



2. STOP OVERSWING in your FM transmission . . . enjoy increased efficiency with better quality.



3. STOP OVERLOADING effects in other program transmission systems by governing even instantaneous peaks.



4. START getting the facts of the new Western Electric 1126A Amplifier, now. It offers an entirely new level controlling circuit with far faster operation, reacting in approximately 1/10,000 of a second to peaks in program input. It offers 5 db increase in average signal level . . . for high quality transmission.

Get the full details. Write or call Graybar today.



DISTRIBUTORS: In U. S. A.: Graybar Electric Company, New York, N. Y. In Canada and Newfoundland: Northern Electric Company, Limited. In other countries: International Standard Electric Corporation.

Western Electric

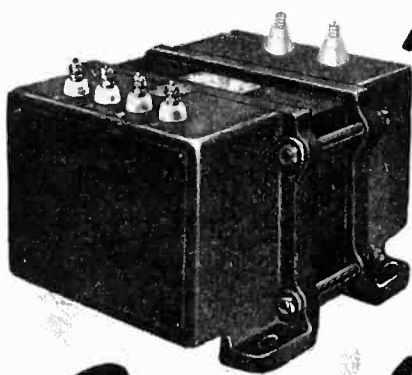

Type W plate transformers and reactors for all small and medium high-voltage rectifiers.

Transformers for Electronic Circuits

... IN ALL RATINGS;
FOR ALL REQUIREMENTS

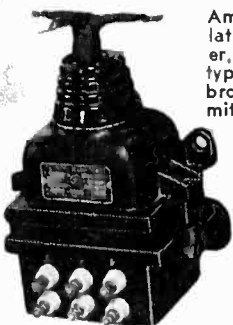

AmerTran modulation transformer, oil-immersed type, for large broadcast transmitters.

Type W filament transformer, air-insulated type, for tests up to 50 Kv.

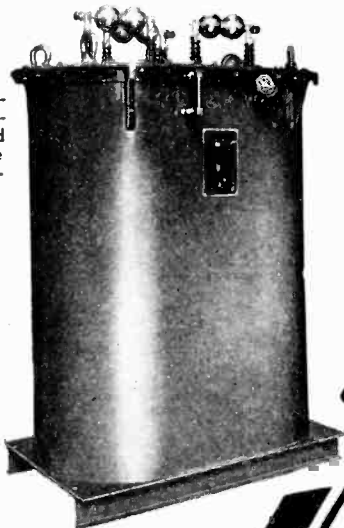

AmerTran audio transformers and reactors are available for all applications and meet exact requirements.

Type RS plate transformers and reactors, oil-immersed type, for large rectifiers.

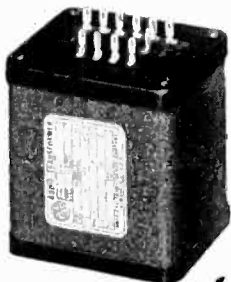

Continuous research work by our engineers since the early days of radio has made and maintained the AmerTran trademark a symbol representing the ultimate in transformers for communication and electronic circuits. This also explains why our products are preferred and used by so many of the largest equipment manufacturers and best-equipped broadcasting stations. Today our list of products covers the complete range of transformer requirements for electronic tube circuits—from the smallest audio unit used in an air-craft radio receiver to the giant power and modulation transformers for a 50,000 watt broadcast transmitter. Furthermore, all types and sizes can be produced economically either singly or in quantity to meet your particular specifications.

Let us submit data on transformers for your requirements.



AMERTRAN

AMERICAN TRANSFORMER COMPANY
178 Emmet St. NEWARK, N. J.

Manufacturers
SINCE 1901
at Newark, N. J.

**THIS CURVE
DOUBLES
THE STRENGTH
OF ANTENNA
STRUCTURE
INSULATORS**

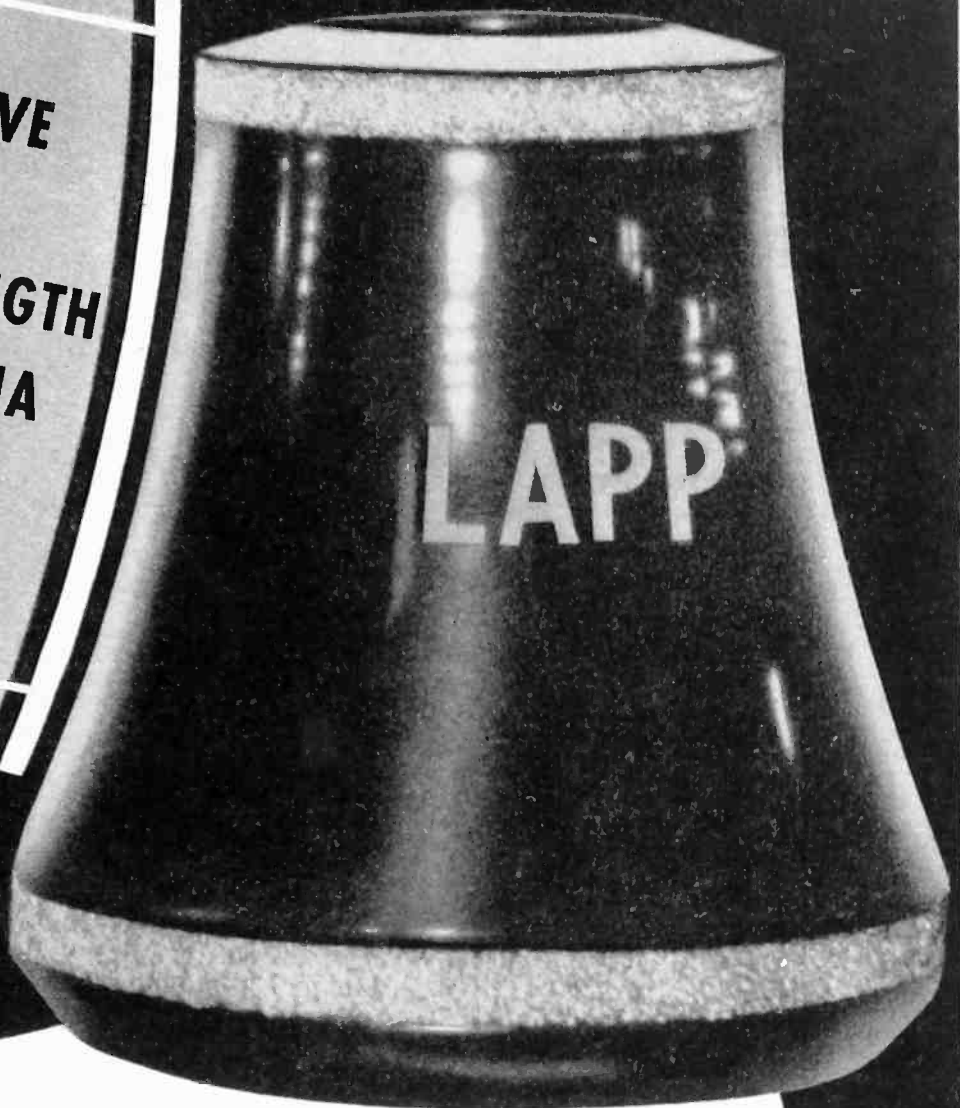

This is the Lapp compression cone of electrical porcelain, a design conceived by Lapp engineers as being most suitable for carrying the mechanical and electrical loads imposed on insulators for antenna structure support. For 20 years every Lapp footing and guy insulator has been built around the porcelain compression cone. The *curved-side* cone, developed as towers went higher and loads heavier, is *twice* as strong as the earlier, straight-side cone. No antenna structure has ever failed because of the failure of a Lapp porcelain part. Lapp Insulator Co., Inc., LeRoy, N. Y.

Specify

LAPP

FOR SECURITY IN ANTENNA STRUCTURE INSULATORS

TWICE TESTED



Specifically Adapted to YOUR JOB

STANDARD "stock" relays? To be sure! Dunco has dozens of them in a line covering a wide variety of application requirements.

Going deeper than this, however, Dunco takes pride in its ability to design special relays, or to adapt standard relays to specific applications—economically, efficiently, and with the utmost dependability assured for every need.

Every Dunco Relay is twice-tested as a unit in addition to many individual component tests during manufacture. Special units are specially designed, constructed and tested for their particular applications, each step being based on broad experience in supplying highest quality products to the nation's most discriminating relay users. Complete catalog gladly sent upon request.

DUNCO RELAYS AND SOLENOIDS

A Complete, Quality Line—Individually Adapted to Your Specific Needs

STRUTHERS DUNN, INC., 1326 CHERRY ST., PHILADELPHIA, PA.

*Gammatrons
of Course!*

*by the
originators of
tantalum tubes*

GAMMATRON

Multi-Unit Tubes

PROVED IN SERVICE

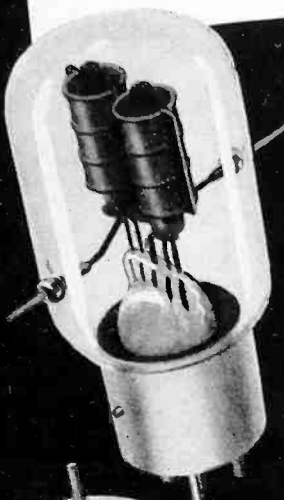

2 TRIODE UNITS This tube was developed over three years ago for Pan American Airways. It is now used in their Clipper planes in daily service over the Atlantic and Pacific Oceans. It is small and has high output at low voltages. Other important characteristics are low noise, low interelectrode capacity, high mutual conductance, and extremely rugged mechanical construction. Plate dissipation 50 watts, maximum power output 200 watts, and filament voltage of 12.6 or 6.3 volts.

158 - Price \$1850

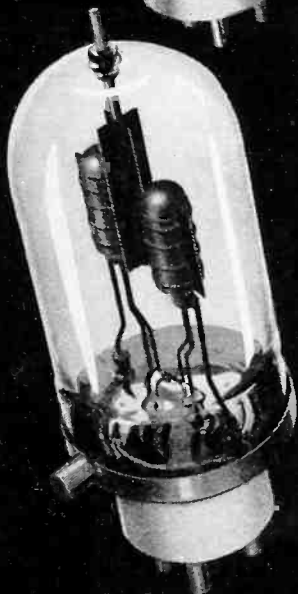

2 TRIODE UNITS The power and performance of two small triodes with none of the disadvantages of a large tube. Two complete triodes connected in parallel giving high efficiencies, very low driving requirements, and ultra high frequency operation up to 200 megacycles. Filament volts 5 or 10, and maximum plate dissipation of 150 watts.

152L - Price \$2000

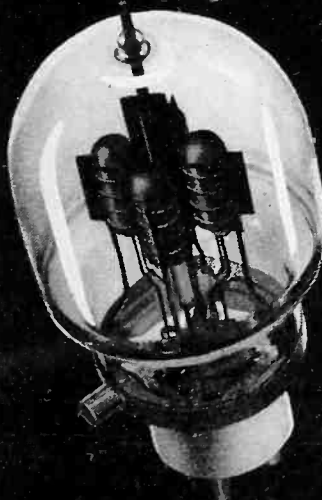

4 TRIODE UNITS A near approach to the ultimate in a large tube for ultra high frequency work. Four complete triode units in parallel to give twice the capabilities of the 152L. Small size, low loss rugged plate and grid connectors, high efficiencies even at low voltages, and low interelectrode capacity make this tube particularly adaptable to frequency modulation and other UHF applications. Filament volts 5 and 10. Maximum plate dissipation 300 watts.

304L - Price \$6500

WRITE FOR DATA

HEINTZ AND KAUFMAN
SOUTH SAN FRANCISCO LTD. CALIFORNIA U.S.A.



SUPERIOR SMALL TUBING
in the hands of the
METALLURGIST

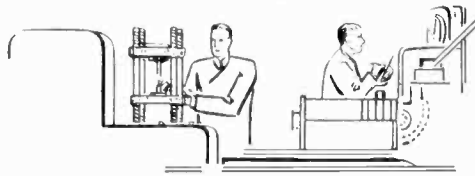

What does the metallurgist demand of small tubing? (max. O. D. $\frac{5}{8}$ "). The answer to that question was not as apparent five years ago as it is today.

At Superior we have found increasing industrial emphasis on grain size of both ferrous and non-ferrous tubing. Metallurgists are becoming much more aware of the fact that controlled structure, proved out by photomicrographic study, is essential to meet certain operating conditions. Superior maintains a close check on the micro-structure of all types and analyses of tubing—this in addition to routine tensile, hardness, flanging, flattening, compression, hydrostatic, stiffness, and flexure tests. We not only control the analyses and structure of raw stock used, but carry this control through to the finished tubing that meets the specification on your order. Remember, if a metal can be drawn, Superior can draw it in small tubing sizes.



SUPERIOR TUBE CO.

[THE BIG NAME IN SMALL TUBING]

NORRISTOWN, PENNSYLVANIA

Your
**METALLURGICAL
 PROBLEM**

Most of our production is to match given specifications, but there are many examples in which our working knowledge of various metals has proved of value to users who do not know the exact temper and analysis necessary to obtain desired properties. Our doors are always open . . .

Tubing from $\frac{5}{8}$ " OD down . . . **SUPERIOR**  Seamless in various analyses. **WELDRAWN**  Welded and drawn Stainless. **BRAWN**  Welded and drawn "Monel" and "Inconel". **SEAMLESS** and Patented **LOCKSEAM** Cathode Sleeves.

" F O R F I N E S M A L L T U B I N G "

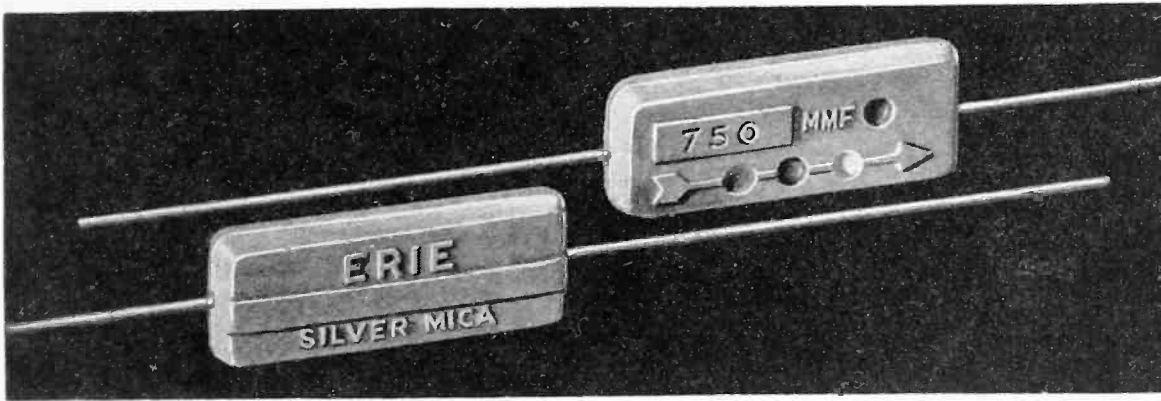

For real punishment—concentration camps have nothing on this

ERIE SILVER MICA TEMPERATURE CYCLING TEST

To most radio engineers the words "Silver-Mica" stand for stability in condensers. To the development and production engineers at Erie Resistor, who are in charge of Erie Silver Mica Condensers, the word "Stability" means as little deviation as possible from original capacity through any number of cycles of severe heat and cold.

Everything possible is done to produce a condenser as nearly perfect as possible. All mica sheets are carefully examined for fractures and air inclusions. The silver coating adheres tightly to the mica film and is applied by a special process with exceptional uniformity. Terminal connections are securely fastened to the sheets. Molding technique is closely controlled and only the best possible impregnating compounds are used.

The result of this manufacturing care is exceptional stability even under abnormal conditions. To demonstrate this, production samples are put through the following cycling test. Units are subjected to repeated 15 minute cycles at -75° F and $+200^{\circ}$ F. The re-

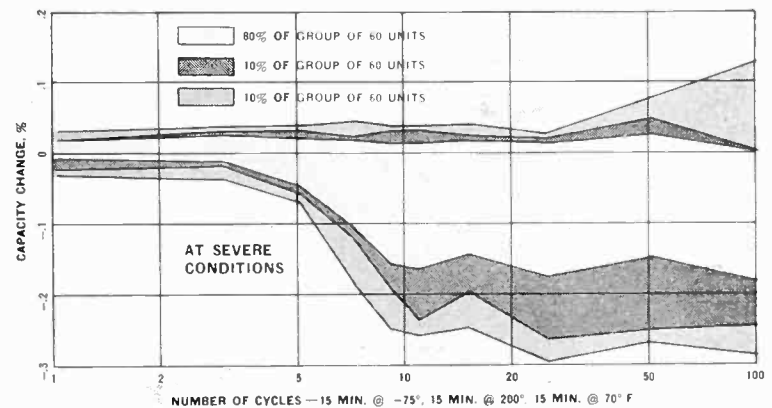

sults of a recent group test are shown above. After 100 cycles, 80% of the Erie Silver Mica Condensers changed less than 0.2%; 10% changed less than 0.25% and the other 10% showed less than 0.3% change. These test results are shown in the chart above. Write for your copy of the Erie composite catalog that describes this and other characteristics of Erie Silver Mica Condensers.

ERIE RESISTOR CORP., ERIE, PA. LONDON, ENGLAND · TORONTO, CANADA.

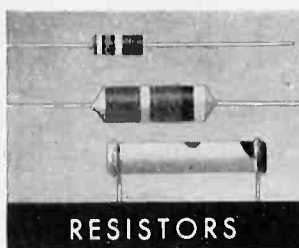

RESISTORS



SUPPRESSORS



SILVER MICAS



CERAMICONS
REG. U.S. PAT. OFF.

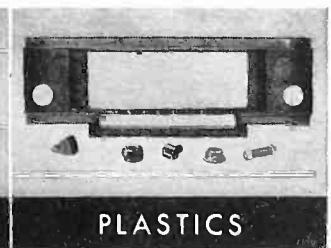

PLASTICS

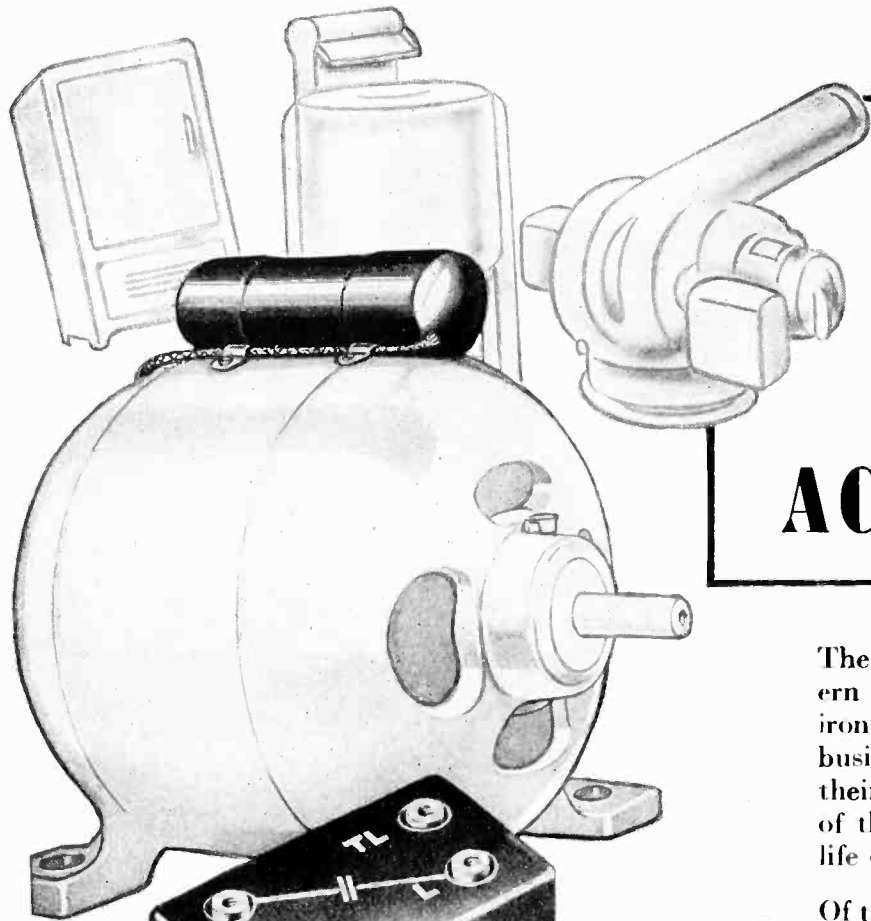

Reliable Motor Operation is Assured with P. R. MALLORY & CO. Inc. **MALLORY** AC CAPACITORS

The satisfactory performance of hundreds of modern electrical appliances—refrigerators, washers, ironers, water pumps, oil burners, ventilating fans, business machines—depends on the reliability of their electric motors. And in turn, the reliability of the motor depends on the efficiency and long life of its starting capacitor.

Of the many millions of AC motor starting capacitors now in use, a vast portion are of Mallory manufacture. Wherever motors require a high starting torque from a single phase power supply, you will find Mallory the preferred capacitor.

You will find other types of Mallory capacitors in leading radio receivers, transmitters and amplifiers. Mallory makes and stocks many standard types, sizes and ratings of dry electrolytic, wet electrolytic, paper and mica dielectric capacitors. If you employ capacitors in your own products, or in their manufacture and testing... turn to Mallory for an unbiased recommendation.

Send
for this
catalog

Mallory's catalog of approved precision products should be in every engineering source file. It saves time and money.

P. R. MALLORY & CO., Inc.
INDIANAPOLIS INDIANA

Cable Address: **PEMALLO**

P. R. MALLORY & CO. Inc.
MALLORY

NATION-WIDE SERVICE THROUGH 253 SELECTED DISTRIBUTORS



CROSS TALK

► \$50 . . . Certain questions should never be asked. One of them is, "Should we have \$50 receivers for frequency modulation?" We believe we should have inexpensive f-m receivers, but we don't believe we should flood the market with "cheap" sets. The two great advantages of frequency modulation for the listener are wide range reception, and reception free from natural static. Cheap sets will not be wideband. You cannot make a good loudspeaker for the price some people are paying for an entire receiver. We believe the price of an f-m set should be high enough to make the owner appreciate it, the tone fidelity should be good enough so that he can tell the difference. Freedom from static is not the only selling point of frequency modulation, but will be if this new service is debauched within a year after it has been made available.

► DEFENSE . . . Early stages of any great democratic movement are discouragingly slow and disorganized. Nothing much, except talk, seems to get done. There is a feeling that nothing will ever get completed in the time allotted. We will be too late, again. Everyone works at cross purposes. Then, slowly, the thing takes hold. Some order is hammered out of the chaos. We are getting to this stage now.

Never have the electronic factories been so busy. Coupled to two years of peak production of radio receivers, transmitters and tubes for ordinary service is the vast defense program whose effects are permeating now to every man. Tremendous assemblies of communication and control equipment are shaping up; and soon will be ready for service. The whole business begins

to take on that inspiring aspect of a great nation of workers united in working for a great cause, working for their own benefit under their own steam and not under the unreasoning lash of a dictator.

Men passing through our office on their way to Washington to offer their services, without pay if necessary; Major Armstrong offering free use of his f-m patents to the government for the duration of the emergency and to manufacturers, designated by the government, use of the patents for one dollar per year; one out of four United States physicists working on problems of national defense; daily calls from large laboratories and manufacturers for qualified men to fill waiting jobs—all these are but aspects of the enlarging picture, all leading to the single national cause, defense.

There are troubles, of course. Aluminum is a mighty important raw material to electronic people. Shield cans and condensers depend upon this element, now so vitally needed for airplanes. There are rumors that one per cent of the annual production will be set aside for non-defense uses. This is small in per cent, large in tonnage. Will radio get its share from this pool; or will radio be classed with other defense projects?

There are certain disquieting matters, too. In the draft, men whose special knowledges and techniques could be put to much better use are driving trucks. Men enlist with some sort of promise of jobs where their special knowledge can be used to best advantage, and *they* find themselves driving trucks; men essential to certain industries and jobs, finding themselves taken away and put on jobs where they seem to be wasted; certain

creaking of the machinery indicating nothing much more than the fact that we are new at this job of defense. Most worrisome of all is the lack of perception among so many people of the serious times we are in.

► INCIDENTALS . . . There is, in New York City, an outfit called the FM Ignition Service company. . . . German manufacturing firms are still paying Britain for the patent rights on certain war machines, and English firms are doing the same for the German Reich. . . . Double correction: anyone interested in skin effect and noticing an item on the subject in this column in February, will please change the multiplying factor from the square root of 1000 to the square root of 1/1000. It will work better that way.

Television gets the go-ahead signal as of July 1 from the F.C.C. which has adopted the standards proposed by the N.T.S.C. Wire manufacturers are faced with an acute shortage of reels, spools and cases, which is delaying shipments. Return containers to manufacturers to expedite, and conserve materials for other uses.

► OBIT . . . Dayton C. Miller, critic of the Einstein theory, author of "The Science of Musical Sounds" (in which is probably the first photograph of a bass voice entering an auditorium), physicist, teacher, widely known for his work in the realm of acoustics, died in Cleveland in February. . . . Egbert von Lepel, inventor of the quenched gap which formed the basis of communication, medical, and industrial machines, died in his laboratory in April, when a tube to a small gas jet became disconnected.

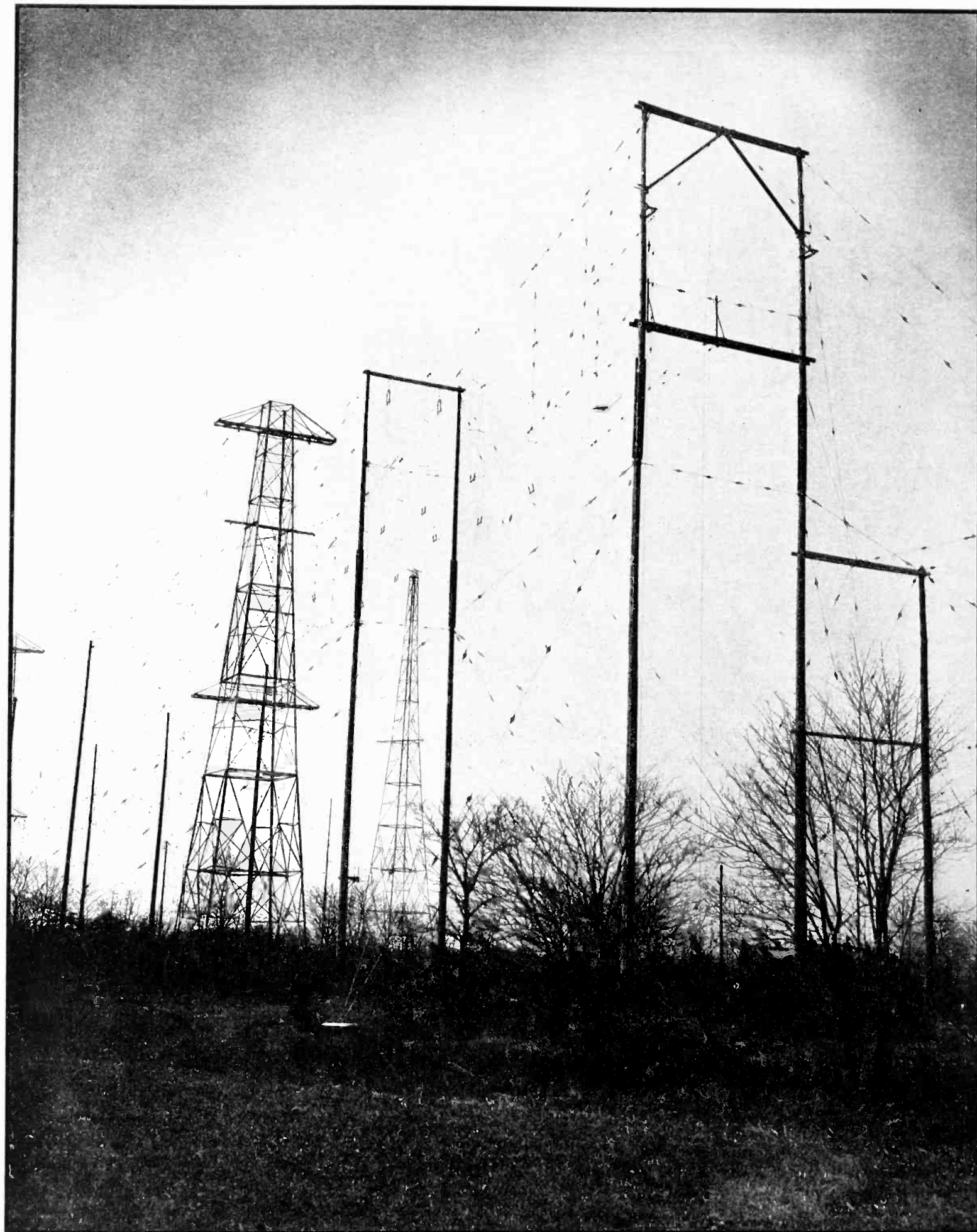

Big Voice for Hemisphere Defense. . . . The threat of aggression forces the neighbors of the Western Hemisphere to act together for mutual protection. This newly-erected array of beam antennas on the grounds of N.B.C.'s WRCA and WNBI transmitters at Bound Brook, N. J., can be directed toward Cen-

tral America and either the east or west portion of South America by properly phasing the input voltages to the various sections. Each antenna is of the double-H type. The array is at times fed by two 50-kw transmitters operating at 9670 kc to give an effective power of 1700 kw in a southerly direction

Priorities—What Effect on the Radio Industry?

Shortages in aluminum, tungsten and nickel offer a serious threat to the established methods of engineering and manufacturing in radio and the allied arts. This survey reveals the steps which have been taken to meet the situation, what substitute materials and revised engineering practices are in prospect

THAT the radio industry is faced with a radical revision in its methods of doing business because of shortages of essential materials is no longer a matter of conjecture. It is a fact. Aluminum, tungsten and nickel, are already under definite priority control of the Office of Production Management (O.P.M.). Zinc is under a partial priority control. Other materials widely used in radio manufacturing, such as copper and magnet steel, while available without official restrictions, are possible additions to the list. The O.P.M. "Priorities Critical List" revised to March 17th indicates preference ratings for completed articles in the radio field such as batteries for radio, ship and fire control, aircraft detection equipment, portable battery chargers, electric cables, radio frequency meters, interphone equipment, insulation testers (meggers) radio apparatus (all types), radio direction finders, underwater sound equipment and anti-aircraft sound locators, and service-type telephone and telegraph equipment.

The classification of "radio apparatus (all types)" on the critical list is so broad that practically all component parts, including tubes, used in radio equipment, as well as complete radio equipment, are subject to control. Government orders for such equipment carry with them a "Preference Rating Certificate" with an A-1 notation, which means that the supplier must give that order preferential treatment, delaying the delivery of all other orders of lower rating, if necessary, in order to meet delivery dates. Where stocks are complete, the priority system usually does not entail any serious delay to the purchasers of radio components and materials, but if

stock is short, the purchaser with a low preference rating or none at all may cool his heels for weeks, or months. The preference rating certificates are issued by the Priorities Division of O.P.M. under the direction of Edward R. Stettinius, Jr. The Army and Navy Munitions Board also issues priority ratings, which are attached to all Army and Navy orders for anything on the critical list. All other orders, government and non-government, are rated by the Division of Priorities. In a few cases, notably those of aluminum, magnesium, machine tools, and neoprene (synthetic rubber), a blanket priority has been set up which applies not only to articles and supplies for defense purposes, but which requisitions also all the left-over supply which would otherwise be available for non-defense use. In the case of machine tools, for example, such a blanket priority allows the machine tool makers to obtain all their supplies under priority ratings.

The Aluminum Situation

The most critical material, so far as the effect of priorities on radio manufacturing is concerned, is aluminum. Aluminum is used in great quantities for the base of instantaneous acetate recording blanks, for variable tuning condensers, for shield cans, in permanent magnets, and in electrolytic condensers.

The priority rating for aluminum used in radio, released on April 18, recognizes that no reasonable substitute exists. The rating given, B-7, means that the radio industry is allotted 30% of its 1940 consumption of high grade material and 60% of low grade material, if and when non-defense supplies are available.

The situation in the acetate record field is acute. For nearly three months the supply of aluminum for all civilian purposes has been cut off. Extensive experimentation has been undertaken with substitute materials, including "superfine" steel, glass, plastics, high grade smooth finish cardboard, zinc, brass and copper, but none of these materials has proved satisfactory thus far. The highly polished surface of "name-plate" aluminum, and its freedom from any tendency to warp make it an ideal material for the purpose. Specially-prepared steel serves for the smaller diameter discs used in the home-recording field, but the surface noise is increased because the finish of the metal is not as smooth as that of aluminum, and the acetate coating faithfully reproduces all the surface irregularities. In the larger size 16-inch discs used in broadcasting, the steel thus far available exhibits warping to such an extent that it is difficult to cut a record without the cutter jumping from the surface of the record. Glass has a good surface, but it is fragile, difficult to ship, and expensive to work (the four holes in each disc must be drilled, not punched). Plastics tend to warp unless a disc of excessive thickness (and consequent high expense) is used. Moreover, the surface is not good, and it is expensive to work the material. Cardboard can be used only if the acetate coating formula is softened to prevent warping and buckling of the base due to the tension of the coating. Such formulas do not cut well, since the thread from the engraving stylus may not be thrown clear, and the high frequency response of the material is limited to a few thousand cycles per second.

Disc manufacturers hope to conserve the supply of aluminum within the industry by offering to buy used discs from their customers at prices only slightly below those prevailing for scrap aluminum. The manufacturer strips the old coating from the disc, and, having secured a license to do so from the O.P.M., sends the aluminum to the aluminum manufacturer for remelting (toll fabrication). The record manufacturer then receives, after several weeks, the equivalent in sheet aluminum suitable for punching into discs. Customers who contribute by selling their old discs in this manner have first call of the new disc supply. Unfortunately, in many cases the disc customer sells his old discs to the neighborhood used-metal dealer, at a somewhat higher rate per pound, and this aluminum is thereby permanently removed from the recording field. The manufacturers are urging their customers to cooperate by keeping the aluminum supply within the field, even though the income thereby derived from the sale of the old discs is somewhat less.

The aluminum situation in the radio receiver manufacturing industry is equally critical, and its effects may be considerably more widespread. About 4,000,000 pounds of aluminum were used in radio manufacturing in 1940. About one half of this amount was used in variable condensers, one quarter in electrolytic capacitors, and the remainder in shield cans, foil for paper capacitors, and the like. About 2,000,000 pounds of permanent magnet steel, of the Alnico type, was used in p-m speakers in 1940, the aluminum consumption for which approximated 400,000 pounds. P-m speakers were used in about 5,000,000 receivers last year, 1,800,000 of which were in battery operated receivers.

The complete cut-off of the aluminum supply has caused great concern within the Radio Manufacturers Association, as might be expected from the figures just quoted. Committees of this organization have consulted with the O.P.M., and have drawn up a plan for substitutions which will sharply reduce the use of aluminum and nickel in the industry.

One of first actions of this group has been a resolution to drop the use of aluminum in all radio manufacturing, with the reservation that aluminum in foil form will probably

be necessary for the production of electrolytic and paper capacitors. Beginning June 15th, variable condensers with iron stator plates will be delivered, and accepted by the manufacturers. Iron for the rotors is not yet provided in the plans, because the extra weight puts a great strain on tuning mechanisms, both manual and automatic, because of a high degree of microphonism loss of shape due to cold flow, and tendency to collect magnetic dust due to residual magnetism. Condenser manufacturers estimate that one third to one half of the aluminum used might be saved if the industry standardized on two-gang condensers, cut the maximum capacitance by a substantial percentage (using proportionately more inductance), cut the clearance between plates, and in general reduced the size of the units.

If aluminum foil is not available for paper capacitors, when present supplies in the hands of manufacturers are used up, the two most promising substitutes are tin and copper foil. Tin is expensive and already in grave danger of complete priority control. Copper is difficult to slit into strips without producing a burr which will puncture the paper dielectric. Copper may also produce harmful chemical reactions with the wax impregnation.

Regarding Alnico permanent magnets the industry is agreed that steels containing no aluminum or nickel must be used for all purposes, except in battery operated sets, where no substitute is available. However, for these necessary p-m units, the smallest possible weight of magnet will be used, reducing the speaker efficiency and putting the burden on the output stage. Further, higher grade steel, and alloys using the lowest possible percentage of aluminum and nickel are proposed.

When all the available substitutions have been made, it is estimated that the amount of aluminum used will be substantially less than the figure set up by the O.P.M. of two pounds per \$100 retail price, which would entitle the industry to the next higher priority rating, or B-6.

With all these plans, however, the manufacturers do not see their way clear to eliminating all aluminum

in radio manufacturing, and the question remains whether the needed minimum supply will be forthcoming. The priority rating of B-7 applies only to stocks available for non-defense purposes, which are for the present non-existent. The industry right now is running on its reserve supply. When that supply is consumed (and the estimates are that this will take from a few months to less than a year, depending on the component in question), no one knows whether further supplies will be available. Most observers at present are rather pessimistic.

The Industry Outlook—Prices

Uncertainty regarding the supply of raw materials has forced many of the components suppliers to abandon fixed price schedules, and to be extremely wary in the setting of delivery dates for non-defense orders. Many prices for parts are now being quoted "on invoice" that is, the price is set at the time of delivery. Equipment manufacturers, buying parts on this basis, are similarly forced to maintain a highly flexible price schedule, with a larger gross margin than usual to take care of contingencies. As the price of components goes up, and as labor costs increase, there must inevitably be a marked rise in the price of the finished product. Industry leaders say that the price structure in the radio industry is in a highly liquid state at present. While price rises have not occurred universally, the industry seems perfectly sure that they will come, and soon.

Profiteering, as such, seems to be virtually absent in the radio field at present. One reason for this, in an industry not above such practices in the past, is the great amount of business now on hand for defense purposes. Estimates made in Washington indicate that defense orders for equipment in the electronics field now total about \$140,000,000, of which \$46,000,000 is for radio equipment. Since one third of the appropriated money has now been converted into orders, there is reason to believe that another \$300,000,000 to \$400,000,000 will be placed in the industry for delivery in the next two or three years.

The manufacturing industry and its suppliers are thus assured of a

(Continued on page 80)

MEASUREMENTS in F-M TRANSMITTERS—I

Since the F.C.C. requirements for commercial broadcasting by frequency modulation are considerably more rigid than for amplitude modulation, more precise measurement techniques are in order. Mr. Thomas outlines the methods of measuring frequency deviation and audio quality in this first installment

H. P. THOMAS

General Electric Company, Schenectady

THE system of wide-band frequency modulation as it is being used for broadcast service is capable of providing highly faithful transmission of speech and music. This is due largely to the great noise reduction of the system and the lack of any high-frequency limitations imposed by adjacent channels such as prevails in the standard wave broadcast band. To maintain a high standard of fidelity in this new field of broadcast transmission, the F.C.C. has set up standards of good engineering practice requiring performance considerably superior to that in the standard broadcast band, and the commercial equipment manufacturers are guaranteeing performance which should exceed the required standards under most conditions. Examples of the requirements and typical performance figures are shown in the accompanying table.

Many people will contend that such high standards of quality are unnecessary, but under the proper conditions some observers can detect distortion as low as 2 or 3 per cent, and certainly noise levels of -60 decibels are detectable, even if not objectionable under normal conditions. It therefore seems probable that these requirements will not be reduced in severity, but may possibly be tightened further in the future.

As a result of the high performance standards required, it is necessary to make measurements with a considerable degree of refinement.

Most of the measurements made on f-m systems are the same or similar to those used with amplitude modulation since both systems are designed to perform the same function, that is, to reproduce audible sounds. However, due to the difference in the method of transmission, we need a slightly different technique in some cases, and new definitions and references in others.

In amplitude modulation one of the basic reference levels is 100 per cent modulation, which represents the maximum modulation capability of a transmitter. With frequency modulation there is no such limitation. Of course the frequency deviation corresponds very closely to per cent modulation in the a-m case,

but there is no definite upper limit. With any particular receiver the amount of frequency swing is limited by the linear range of the slope circuit which converts the frequency modulation into amplitude modulation for detection; but this limit is an entirely arbitrary one, and can be varied within almost any desired limits. The choice of a suitable upper limit to the frequency swing is based on the channel width which it is permissible to use without seriously limiting the number of channels and the noise level which can be tolerated, since the noise level decreases as the frequency deviation ratio is increased.

Fortunately, this matter has been crystalized since the F.C.C. began

Frequency-Modulated Signal

(1) $e = \sin(\omega t + m \sin \mu t)$
 ω = angular velocity of carrier
 μ = angular velocity of modulation
 m = deviation ratio = $\frac{\Delta\omega}{\omega}$

By expansion

(2) $e = \sin \omega t [J_0(m) + 2 \sum_{n=2,4,6,\dots} J_n(m) \cos n \mu t]$
 $+ \cos \omega t [2 \sum_{n=1,3,5,\dots} J_n(m) \sin n \mu t]$

(3) $e = J_0(m) \sin \omega t + J_1(m) [\sin(\omega + \mu)t - \sin(\omega - \mu)t]$
 $+ J_2(m) [\sin(\omega + 2\mu)t + \sin(\omega - 2\mu)t]$
 $+ J_3(m) [\sin(\omega + 3\mu)t - \sin(\omega - 3\mu)t]$
 $+ \dots$

$J_0(m) = 0$ for $m = 2.4048$
 5.5201
 8.6537
 11.7915

Fig. 1—The fundamental frequency modulation equation and its expansion to show the sidebands. The Bessel function of zero order (carrier voltage) may be made to vanish at certain deviation ratios, thus providing easily-found check points in measuring the deviation

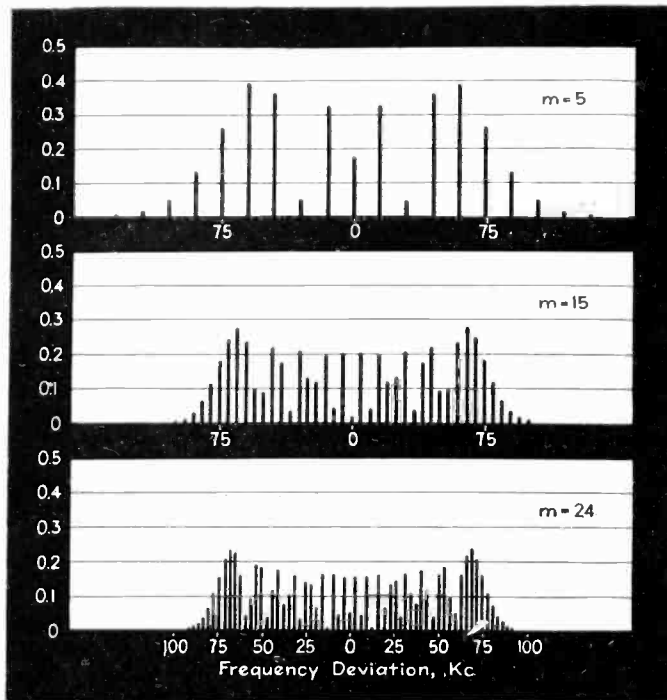

Fig. 2—Typical sideband magnitudes for different deviation ratios, computed for a maximum range of plus or minus 75 kilocycles

assigning licenses on the basis of 200 kilocycle channel separation and has therefore specified ± 75 kilocycle as 100 per cent modulation in its standards of good engineering practice. This is sufficient frequency swing to obtain good noise reduction, while leaving some margin as a guard band to prevent adjacent channel interference.

The first measurement problem is, then, to measure the frequency deviation of an f-m signal. In order to see how this may be done, let us examine the equation for an f-m wave (Fig. 1). Equation 1 represents a carrier having an angular velocity $\omega = (2\pi f)$ being frequency or phase modulated $\pm \Delta\omega$ at an angular velocity μ . By mathematical expansion, we can convert this equation into the form shown in Eqs. 2 and 3, which represents the same wave in the form of a carrier and side bands. This transformation of the equations is similar to what we do with amplitude modulation when we consider a wave of varying amplitude as a carrier and side bands. However, in the f-m case there are an infinite number of side bands, all spaced from the carrier by multiples of the modulating frequency, the amplitude of each one being given by the Bessel functions $J_1(m)$, $J_2(m)$, and so on, m being the deviation ratio. We will also notice that the carrier amplitude is not constant, but depends on the value of the zero-order J_0 Bessel function.

and varying the frequency of the audio input. It will be noticed that as μ decreases m increases and more side band terms appear, becoming spaced closer together. In all cases there is very little energy far outside the limits of the frequency swing. Now suppose that we want to accurately measure a frequency deviation of ± 75 kilocycles. By referring to Eq. 3 we see that the carrier amplitude is given by the function $J_0(m)$ and by examining the tables we find that this is zero for various particular values of m . Thus by using a modulating frequency of 13,586 cycles and a sharply tuned receiver (for instance one having a crystal filter) and watching the amplitude of the car-

rier as recorded on a signal strength or a-v-c meter while we increase the amplitude of the modulating voltage impressed on the transmitter, we will notice that the carrier strength will reach a minimum at a level corresponding to 32.66 kilocycles swing, where $m = 2.4048$, and a second minimum at a level corresponding to 75 kilocycles swing, where $m = 5.5201$.

This gives us quite an accurate measure of the deviation of a transmitter at the higher modulating frequencies, but is not applicable to the lower frequencies since the side bands will then be so close together that it will be impossible to separate them from the carrier with the receiver, and also it will be necessary to count up to very large numbers of carrier null points for normal frequency deviations since m becomes very large.

A method of measuring frequency swing at low modulating frequencies follows from an examination of the diagrams in Fig. 2, which indicates that as the deviation ratio is increased, we are approaching the limiting case of a nearly uniform distribution of energy out to the edge of the frequency swing and zero beyond this point. Thus by using the highly selective receiver again and tuning across the frequency band occupied by the transmitter while it is modulated with a tone of say 50 cycles per second, there will be a fairly steady signal received within the limits of the transmitter deviation and very little signal beyond the limits of this region.

We have found that slightly more

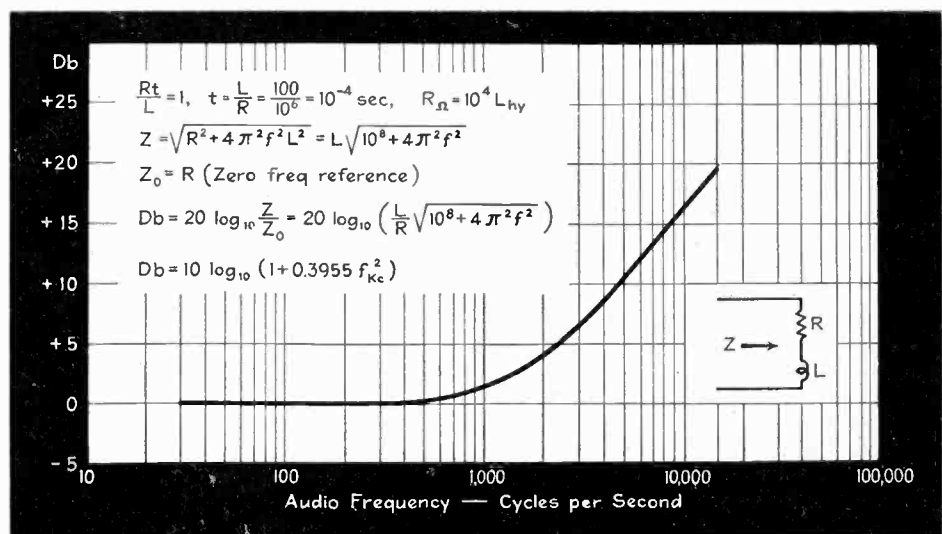

Fig. 3—The pre-emphasis curve specified as standard for commercial f-m transmissions (impedance characteristic of series inductance-resistance circuit, having a time constant of 100 microseconds)

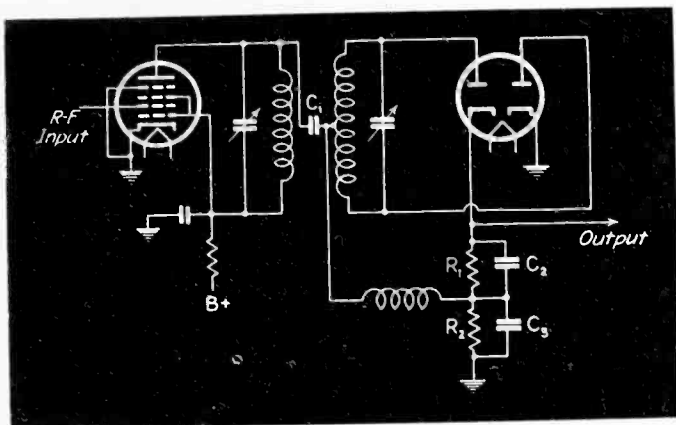

Fig. 4—Typical discriminator (frequency-modulation detector) circuit. This circuit is used in deviation monitors as well as in receivers

accurate results can be obtained by using a heterodyne oscillator in the receiver during this measurement and noting when the transmitter signal sweeps down to zero beat with the receiver oscillator at the end of the frequency deviation cycle. We have checked this method against the carrier null method by reading the output from a linear slope circuit and detector caused by a transmitter which has had the deviation adjusted by each of these methods and found an extremely close agreement.

These methods cannot be used for monitoring a program since they require the application of a steady tone modulation in order to take readings. However, both methods are suitable for calibrating some indicating device which can be used as a modulation indicator. All that is needed for this purpose is a linear slope circuit and detector, or in other words an f-m detector. However, in order to make the output amplitude correspond directly to frequency deviation, some provision must be made to maintain a constant input. This may be done by using a good limiter or by reading the input voltage with a meter and adjusting to the same level for all readings. This circuit will deliver an audio output voltage having a magnitude directly proportional to the frequency deviation of the signal.

The audio voltage can be utilized in a number of ways: it could be applied directly to a cathode-ray oscilloscope for instance. But it is probably more convenient to apply it to a peak reading vacuum tube voltmeter to read peak modulation swing in the same way as is cus-

tomarily done in reading peak modulation in a-m broadcast transmitters. The audio voltage may also be used for operation of an amplifier and loudspeaker for aural monitoring. However it must be remembered that de-emphasis must be used in this case in order to reproduce the sounds correctly as the transmitter is pre-emphasized according to the curve shown in Fig. 3. To make the monitor more convenient to adjust for operation on various carrier frequencies and to standardize the design of the slope circuit, it is advantageous to employ a converter and have the slope circuit and detector operate at the intermediate frequency. In other words, we use a simplified receiver.

Figure 4 shows the circuit of a discriminator and Fig. 5 shows the characteristics of a discriminator of this type. If this characteristic can be made sufficiently linear over the required frequency range, the circuit can be employed to measure all the audio characteristics.

The only fundamentally sound method known to the writer for measuring linearity is to measure the output voltage with a d-c instrument and vary the applied frequency by accurately known steps. The frequency steps can be determined with very good accuracy by synchronizing the applied frequency oscillator with harmonics of a 10-kilocycle crystal oscillator. This is a

somewhat difficult measurement to make as all the conditions must be maintained very accurately during the time necessary to read a fairly large number of points. For example, the voltage from the oscillator delivering the input signal must not vary during the measurements, or if a limiter tube is used to maintain constant input, the voltages on the limiter must not change enough to affect its output. To obtain sufficient accuracy in measuring the output voltage will probably require the use of a potentiometer. For preliminary adjustments, it is advisable to use a sweep oscillator and oscillograph in the method commonly used for receiver alignment. The accuracy of this method depends on the linearity of the sweep circuits and the linearity of the deflection of the oscillograph, so it cannot be depended upon too much for accurate results.

Carrier Noise Level

Suppose we wish to measure the carrier noise level of a transmitter. First of all we must set the modulation level of the transmitter at ± 75 kilocycles, or 100 per cent modulation, by one of the methods described earlier in this article. This gives a certain audio voltage level out of the modulation monitor corresponding to 100 per cent modulation, that is, this sets the decibel reference level. All audio input to the transmitter is then removed and the noise level output read by means of a suitable tube voltmeter. The ratio of noise voltage to 100 per cent modulation signal level is the carrier noise level, assuming no noise is introduced by the measuring equipment. How closely this condition is met can be determined by taking a measure-

Fig. 5 — Discriminator characteristic of the circuit shown in Fig. 4. The slope must be very accurately linear over the range of 200 kc for accurate monitor work

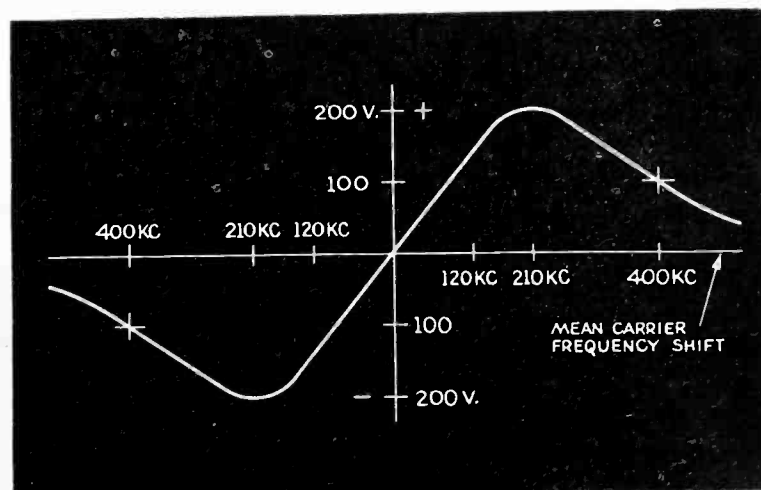

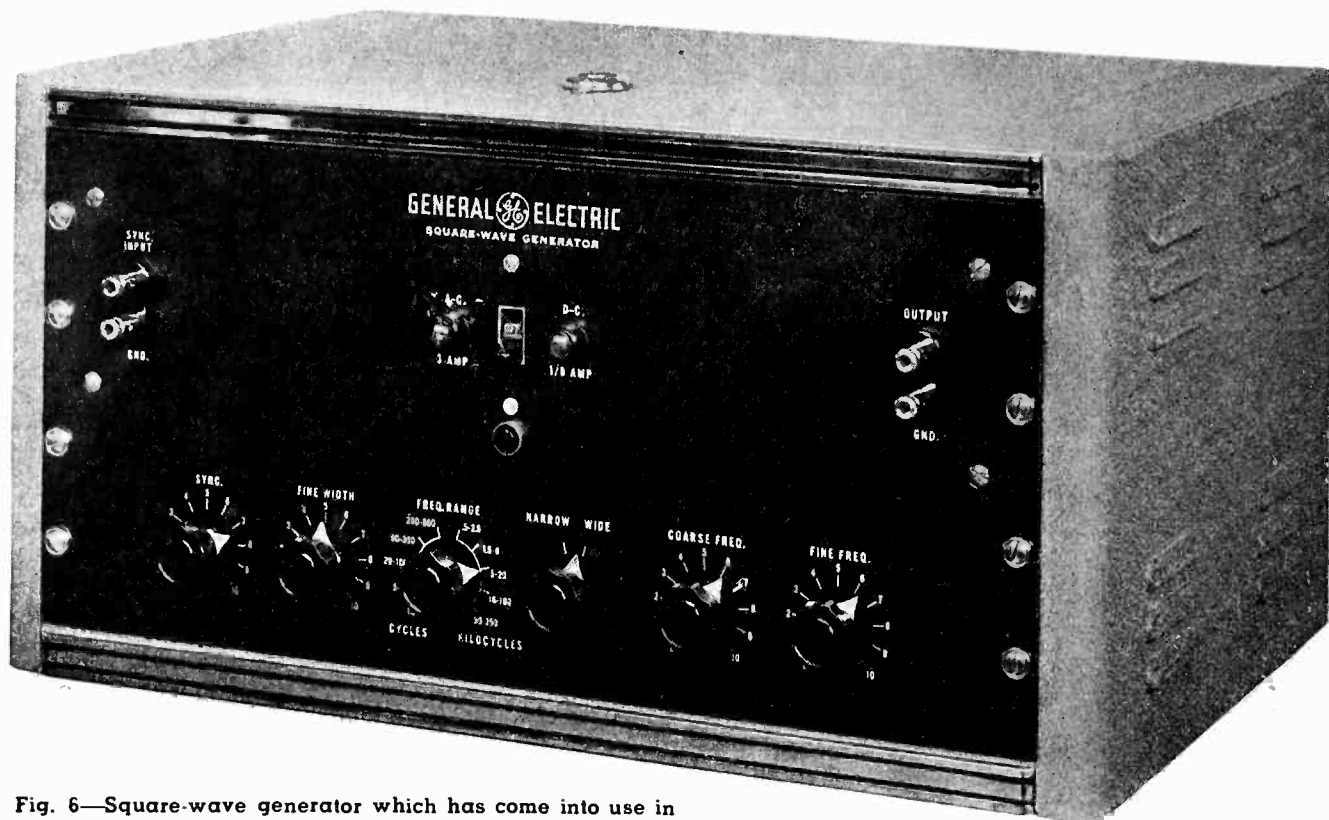

Fig. 6—Square-wave generator which has come into use in testing the waveform reproducing capabilities of an f-m system. Transient wavefront should be reproduced accurately when the full range of audibility is employed

ment of the noise, read when a signal is fed to the monitor from a good crystal oscillator, which will have practically zero frequency modulation. During this measurement, as in fact for almost all the audio measurements, de-emphasis should be used, since this is the condition under which the normal receiver operates. A convenient instrument for this type of measurement is a noise and distortion meter which consists of a vacuum-tube voltmeter calibrated in decibels and equipped with attenuators for reading large changes in level.

Distortion

For measuring harmonic distortion, we can measure the audio output of the modulation monitor by means of a noise and distortion meter, which balances out the fundamental and leaves the distortion terms to be read on a tube voltmeter, indicating total r-m-s voltage; or we can use a wave analyzer, which is a very selective filter for selecting any single frequency, and measure the fundamental and each of the harmonics separately. The wave analyzer gives a little more information by separating the various harmonics. This may be useful in analyzing the source of distortion,

but is a little slower than the distortion meter and requires some calculation to determine the total distortion. Care should be taken to use a source of audio frequency having very low harmonic content if distortion readings as low as 2 per cent or less are to be made.

Audio Frequency Response

Frequency characteristics can be measured easily with a modulation monitor and some form of tube voltmeter, reading audio output from the monitor against audio input to the transmitter over the entire audio band. In all of these measurements, care should be taken to make certain no r-f voltage is introduced to the measuring equipment. It is often desirable to put an r-f choke at the input of the measuring equipment, but it is necessary to be sure that it is not so large as to affect the audio-frequency response. Shielded leads can be used if care is taken to make certain that they do not have so much capacity that they affect the audio characteristics. It should also be mentioned that to assure a good audio-frequency characteristic from the modulation monitor, the r-f bypass condensers should not be too large. Calculation of impedances will tell whether they

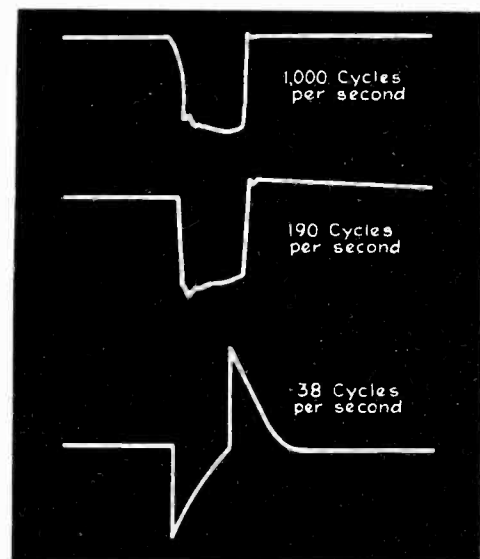

Fig. 7—Square waves traced from an oscilloscope connected to a developmental receiver. The pulse width in this case is 15 per cent of the total square wave period

have any appreciable shunting effect on the load resistors at the highest audio frequency. It should be noted that in a discriminator the capacity coupling the primary and secondary coils is also shunting half the audio load, the hence should be made fairly small.

Cross Modulation

Most of the measuring equipment available will not permit harmonic measurements at frequencies above about 15 or 20 kilocycles. Harmonics at frequencies higher than this are not audible so it might seem that it

F.C.C. Performance Requirements and Typical Commercial Transmitter Characteristics

Freq. characteristic	± 2 db 50-15000	± 1 db 30-16000
Distortion	2% rms ± 75 kc	1.5% ± 75 , 2% ± 100 kc
Noise level	Better than 60 db	70 db
Mean carrier stability	± 2 kc	Under 2 kc, usually $\frac{1}{2}$ to 1 kc

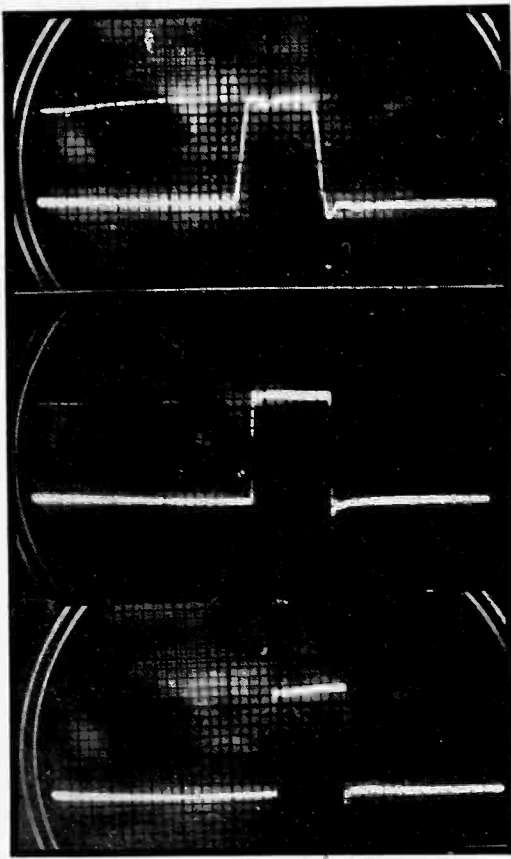

Fig. 8—Square waves reproduced after passage through an f-m transmitter and discriminator receiver. Frequencies from top to bottom are 1000, 190, and 38 cycles per second

would be useless to make distortion measurements at modulating frequencies above about 7 kilocycles. However, a non-linear characteristic at the higher audio frequencies will cause cross modulation which will be audible. Special measuring equipment can be used to measure the super-audible harmonics, but the same result can be obtained by actually modulating with two tones simultaneously and measuring the cross modulation terms. This is a more direct and fundamental method since it actually measures what we hear. Also there is some difference in the results in the case where pre-emphasis is used, as is standard in f-m transmission. The difference is that harmonics of the higher audio frequencies are de-emphasized in the receiver whereas the difference term resulting from cross modulation is actually increased in amplitude in comparison with the fundamental tones, since it comes at a lower frequency. Cross modulation terms result from curvature of an amplitude characteristic in exactly the same way as harmonic distortion terms. For example, a second harmonic is the result of a square law term in the power series expression for the amplitude characteristic. If two

modulating frequencies each half the size of the single frequency used previously are applied simultaneously, the same square law term will give sum and difference terms each half as large as the second harmonic term found previously. So if we add all the cross modulation terms as an r-m-s sum and express them in per cent of 100 per cent modulation, they should have an amplitude about 0.7 of the distortion terms obtained with a single modulating frequency. In making cross modulation measurements care should be taken not to have the two audio oscillators too tightly coupled to each other or cross modulation may take place in the output stages of the oscillators. This can be checked by a measurement taken directly at the input terminals of the transmitter. Of course, for these measurements it is necessary to use a wave analyzer.

One characteristic of a transmission system which usually is not considered is the phase characteristic or time delay error. In the past this has been considered unimportant. However, phase errors can seriously distort transient wave

fronts, so it would seem that for true high fidelity reproduction it might be important to keep such errors small. A simple method for checking frequency characteristic and phase characteristic simultaneously is to apply a square wave to the input of the system and observe the shape of the wave which appears at the output by means of a cathode-ray oscillograph. A square wave is rich in harmonics, and if any of these components is changed in amplitude or phase, as compared with the others, the output wave will show distortion. Figure 6 shows a unit which will generate square waves having a repetition rate anywhere from 1.5 to 250,000 cycles per second, and two widths, one about 10 per cent and the other 50 per cent of a full cycle. These are adjustable over a small range. Figure 8 is a photograph of the cathode-ray screen when 16 per cent pulses having fundamental frequencies of 38, 190, 1000 cycles per second were passed through a f-m transmitter and a modulation monitor. It will be noted that at 1000 cycles per second we can observe a definite slope to the sides of the wave, indicating a limitation of the frequency band being passed, although this limitation is at a frequency in the order of 20 kilocycles or more. There is also a slight oscillation at the beginning and end of the pulse. That is due to the pre-emphasis circuit, which consist of series L and R , resonating with the shunt circuit and tube capacity. The resonance is fairly heavily damped, and is at a frequency of about 20 or 25 kilocycles, so is outside the audible region. Figure 7 is a tracing made from the cathode-ray oscillograph when the same pulses have passed through the f-m transmitter and also a developmental f-m receiver. These show a fairly large phase error at low frequencies as well as some other irregularities in the characteristic at higher frequencies. Figure 9 shows how the phase shift of an R - C network can be analyzed in terms of the square wave response.

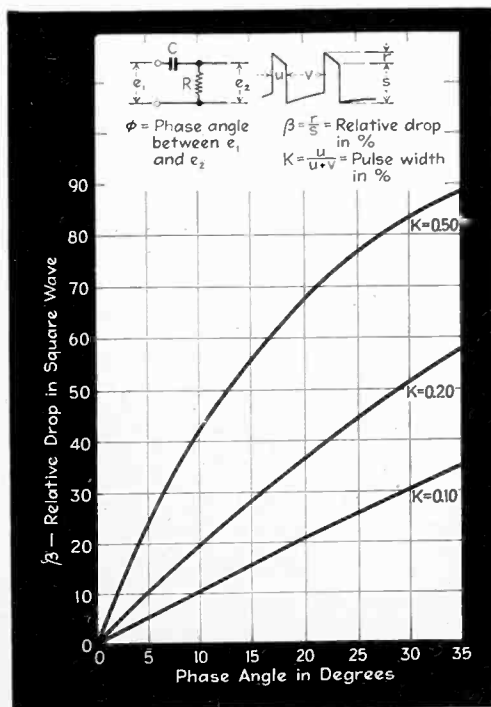

Fig. 9—The relationship between square wave dimensions and phase shift in an R - C combination, for various percentage pulse widths

VOLTAGE MULTIPLIER

By D. L. WAIDELICH

University of Missouri

A RENEWAL of interest in the voltage doubling rectifier circuits has been brought about by their use as d-c power supplies in small radio receiving sets. In this application these circuits have the important advantage of supplying high d-c voltages without the use of heavy and bulky power transformers. Other uses of voltage doublers include power supplies for x-ray tubes and cathode ray tubes. A recent article¹ by M. A. Honnell suggests several new applications of these circuits among which are the uses as a diode detector and as a vacuum tube voltmeter circuit.

Another circuit used for voltage multiplying is the voltage quadrupler first described by W. W. Garstang² and later given in improved form³. A circuit with a voltage output between that of the voltage doublers and that of the voltage quadrupler is the voltage tripler, a circuit believed to be original with the author.

The schematic diagram of the half-wave voltage doubler is shown in Fig. 1 where E_{AC} is the applied a-c voltage, E_{DC} is the d-c output voltage, I_{DC} is the output direct current and the load is represented by the resistance R . In operation for the first half cycle of E_{AC} condenser C_1 is charged to the peak value of the a-c voltage through tube T_2 . During the next half cycle the voltage across C_1 adds to E_{AC} and charges condenser C_2 through tube T_1 to approximately twice the peak value of

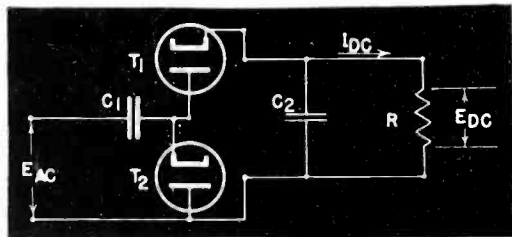

Fig. 1—Circuit diagram of half-wave voltage doubler. C_1 is first charged through T_2 . The voltage across it is then added to the input voltage to charge C_2 through T_1 .

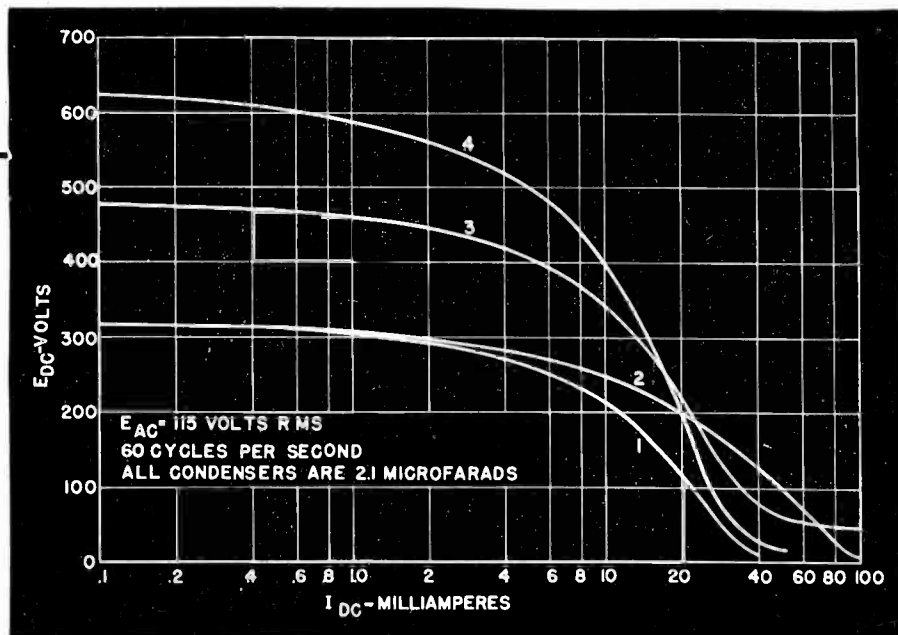

Fig. 2—Output voltage characteristics of doubler, tripler and quadrupler

E_{AC} . Curve 1 in Fig. 2 gives the output voltage as a function of the output current with $E_{AC}=115$ volts rms and a frequency of 60 cycles per second. All condensers are 2.1 microfarads, and this value of capacitance was chosen to give as much of the voltage curves as is possible within the current ratings of the tubes used in the tests. In practice the value of capacitance will usually be much greater. The tubes used were chosen to have low tube drop during conduction. At low values of output current the output voltage is practically equal to twice the peak value of E_{AC} , and it is from this fact that this circuit gets its name of doubler. As the current increases, the voltage decreases and approaches very low values at high currents. The ripple voltage across the output will have the same frequency as that of E_{AC} . In the design of this circuit it should be remembered that C_1 must be able to withstand a voltage equal to the peak value of E_{AC} , while C_2 must withstand a voltage equal to twice the peak value of E_{AC} .

The full-wave voltage doubler circuit is given in Fig. 3, and it resembles two ordinary half-wave rectifier circuits in series. During the

first half cycle of E_{AC} condenser C_1 is charged to the peak value of E_{AC} through tube T_1 , while on the second half cycle condenser C_2 is charged similarly through tube T_2 . The voltage output curve is curve 2 of Fig. 2, and again the voltage at light loads is practically twice the peak value of E_{AC} , while at heavy loads the voltage becomes very small. In this case the ripple voltage will have a frequency twice that of E_{AC} .

In comparing the respective merits of the two doublers the full-wave doubler has the following advantages:

1. The d-c output voltage is greater as shown by comparing curves 1 and 2 of Fig. 2.

2. The output ripple voltage frequency is higher and is therefore easier to filter.

3. The maximum voltage that the condensers must withstand is only the peak value of E_{AC} .

On the other hand the half-wave doubler has the advantage of having a common input and output terminal, and this may be important in such cases as that of radio receiver power supplies.

For higher voltages the voltage tripler and quadrupler are appli-

CIRCUITS

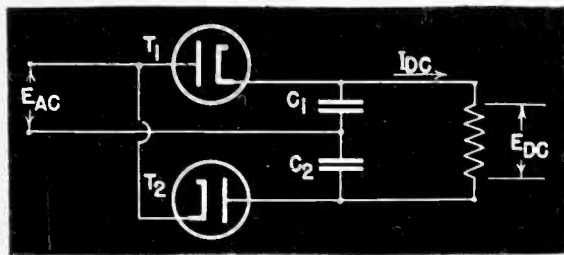

Fig. 3—Full wave voltage doubler which resembles two half-wave rectifiers in series

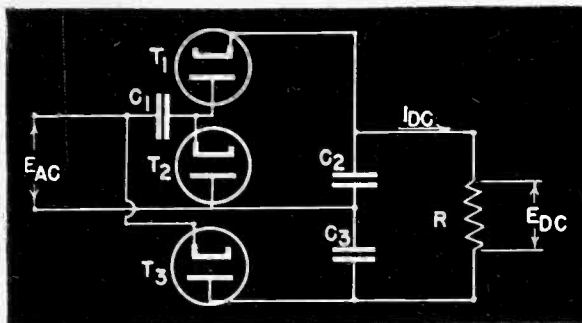

Fig. 4—Voltage tripler circuit, a doubler circuit in series with a half-wave rectifier

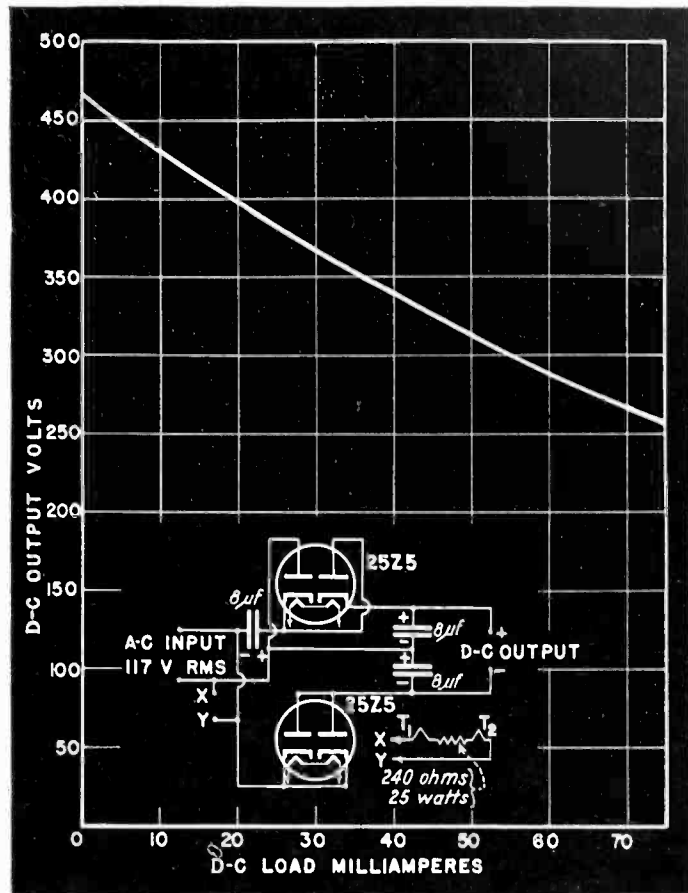

Fig. 5—Practical voltage tripler circuit and its d-c load characteristic

cable, and the circuit of the tripler is given in Fig. 4. The circuit resembles that of a half-wave doubler in series with an ordinary half-wave rectifier circuit. Condenser C_1 is charged to the peak value of E_{AC} through tube T_2 during the first half cycle of the input voltage, while at the same time C_3 is charged through T_3 to the same potential. On the second half-cycle the voltage across C_1 adds to E_{AC} to charge C_2 through T_1 to almost twice the maximum value of E_{AC} . The voltage across R will be the sum of the voltages of C_2 and C_3 or practically three times the peak value of E_{AC} . The output voltage curve is 3 of Fig. 2, and again the voltage is low for heavy loads. Since the circuit is not symmetrical, the ripple voltage will have the same frequency as E_{AC} . Condensers C_1 and C_3 must be chosen to stand a potential equal to the peak of E_{AC} , while C_2 must withstand twice that potential. A practical tripler circuit using standard tubes and condensers is shown in Fig. 5, and with it is also the d-c load characteristic giving output voltage as a function of load current.

Figure 6 shows the circuit of the quadrupler, and it appears to be

made up of two half-wave doublers in series. In the upper half of the diagram and during the first half cycle of E_{AC} , C_1 is charged to the peak of E_{AC} through T_2 , while for the second half cycle the voltage across C_1 adds to E_{AC} to charge C_2 through T_1 to practically twice the maximum value of the applied a-c voltage. The action of the lower half of the circuit is exactly the same as that of the upper half except that tubes T_1 and T_3 conduct during one half cycle while T_2 and T_4 conduct during the succeeding half cycle. The load voltage will be the sum of the

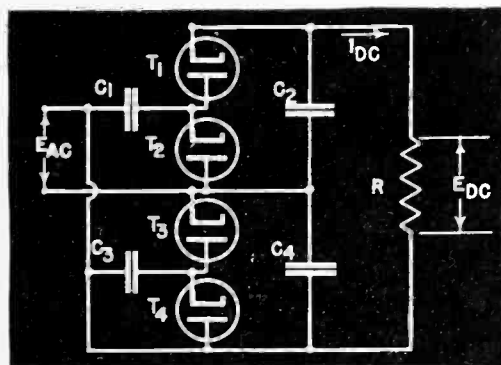

Fig. 6—Voltage quadrupler circuit. Two doubler circuits are connected in series to produce four times the input voltage

voltages across C_2 and C_4 , and at light loads E_{DC} will be practically equal to four times the peak value of E_{AC} . Thus condensers C_1 and C_3 must withstand the peak of the a-c voltage, while C_2 and C_4 must withstand twice that voltage. Curve 4 of Fig. 2 shows the voltage across the load resistance R , and this output voltage has a ripple frequency of double that of E_{AC} .

If the value of the capacitances is increased, the voltage regulation of any one of these circuits will be improved, and in addition the capacitances need not be equal. The output ripple voltage may be decreased, if necessary, by introducing a low-pass filter before the output resistance. Full-wave rectifier vacuum tubes with separate indirectly-heated cathodes are very well fitted for use in these circuits, although the maximum current, the average current, and the inverse peak voltage ratings of the tubes should not be exceeded.

REFERENCES

- 1 M. A. Honnell, Applications of the Voltage Doubler Rectifier, *Communications*, Volume 20, January 1940, page 14.
- 2 W. W. Garstang, A New Voltage Quadrupler, *ELECTRONICS*, Volume 4, February 1932, pages 50-51.
- 3 "The Radio Amateur's Handbook", 1939 edition, page 357.

Facsimile Speeds Air Reconnaissance

Facsimile transmission of photographs from an airplane to ground requires only ten minutes between making an aerial picture and using it in military action, in a system recently demonstrated by the Finch Telecommunications Laboratories.

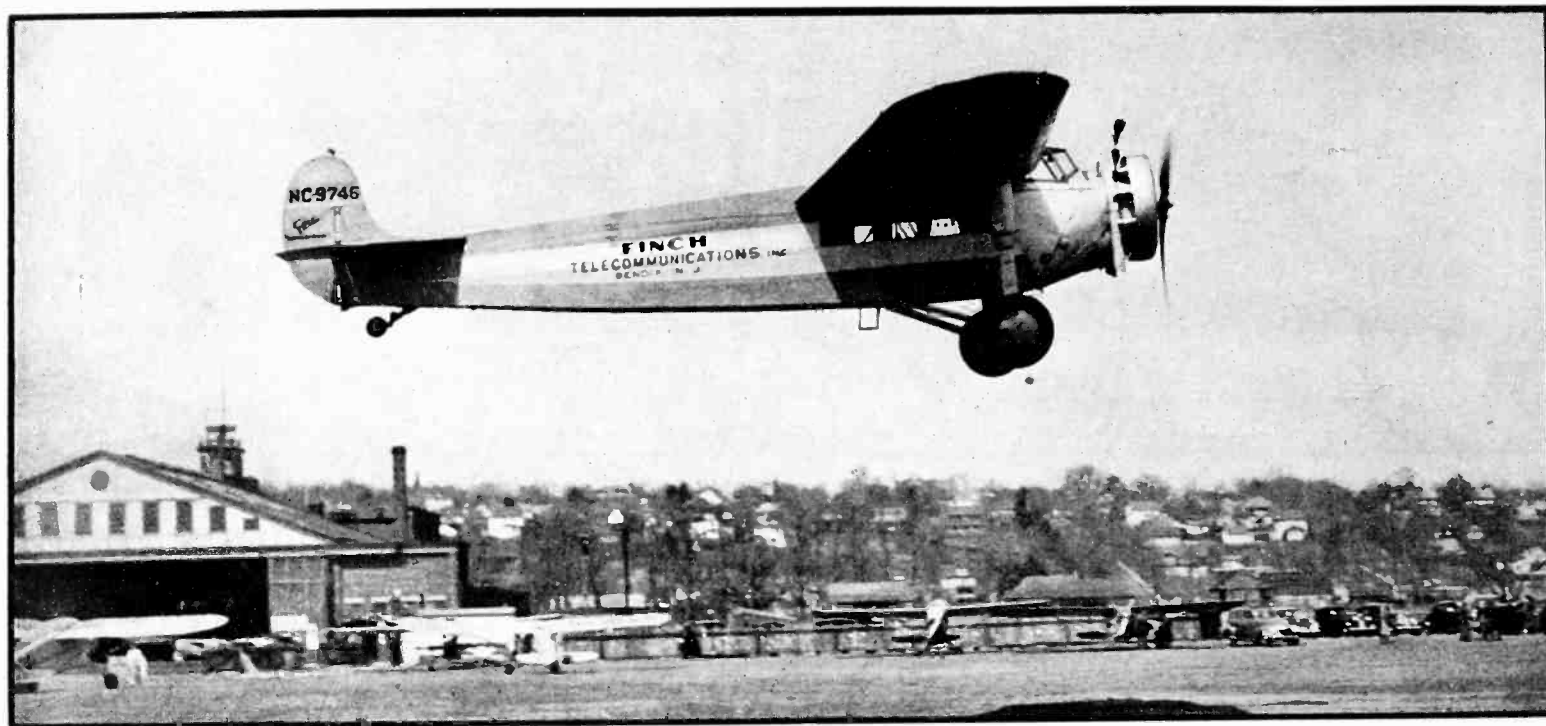

Fig. 1—A complete sending and receiving facsimile system is contained in this airplane. The picture signal, as well as voice multiplexed on the same channel, is transmitted by frequency modulation

Fig. 2—An oil tank farm, a military objective in time of war, is photographed. Within ten minutes, a print of this picture can be in the hands of officers at headquarters many miles away



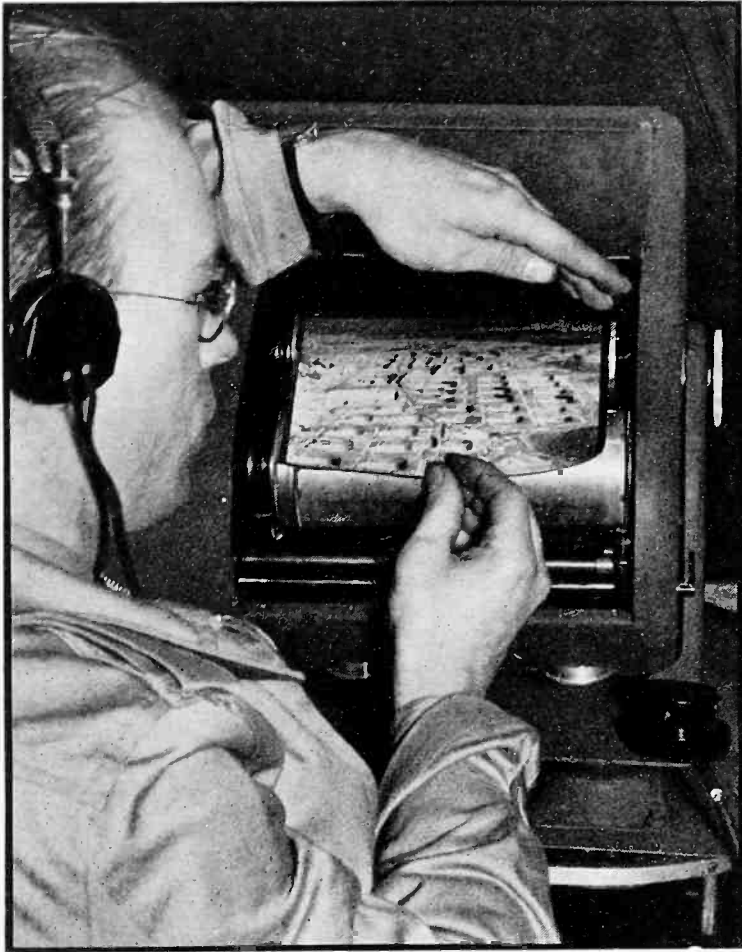

Fig. 3—Lower right, the photograph is made on a paper negative and developed in a high speed developer (time of development, 1 minute) and placed on the transmitter as a negative

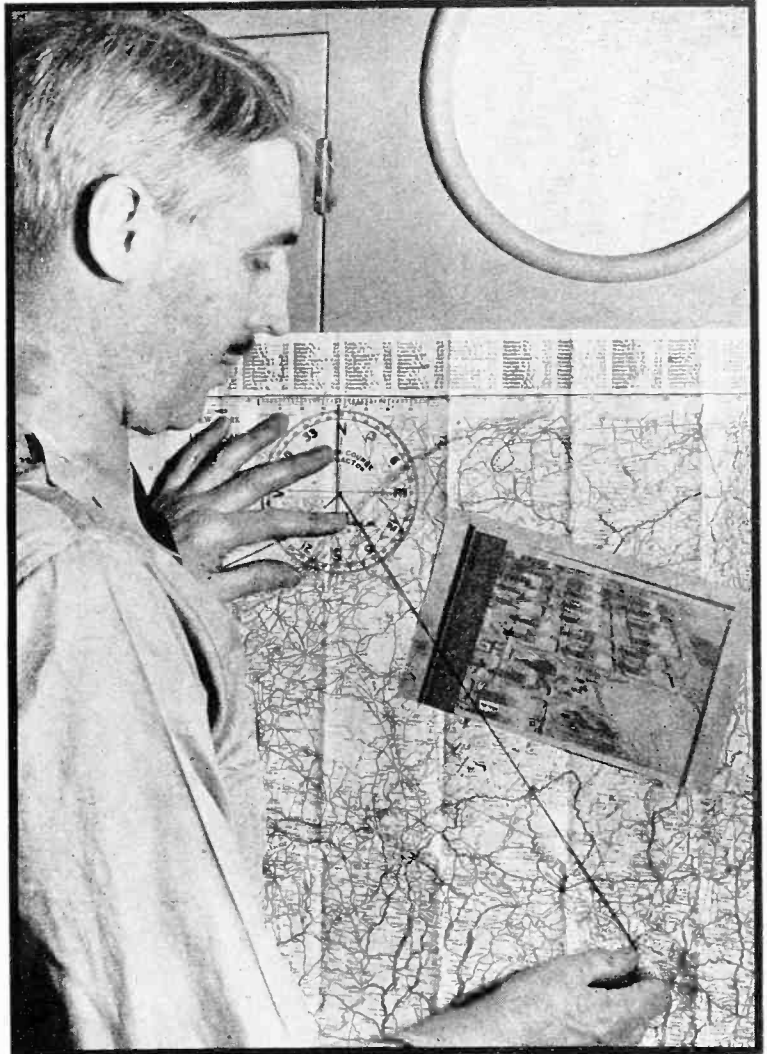
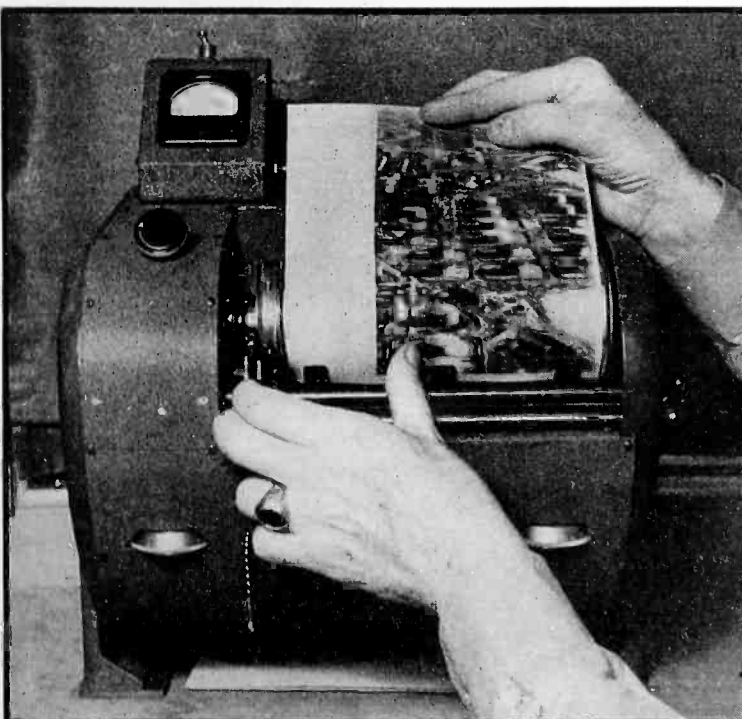

Fig. 4—Above, the picture is transmitted at the rate of 8 square inches per minute or about 8 minutes for a picture of standard telegram size, 8 3/4 by 7 inches. The signal is applied to the f-m transmitter at the microphone input terminals

Fig. 5—Below, the picture is received as a positive print by reversing the polarity of the picture signals. Synchronism is obtained by a voltage impulse at the end of each revolution

Fig. 6—Upper right, the finished picture in use. The receiving paper requires no chemical treatment and can be handled roughly without showing wear or other markings



PUSH-BUTTON SWITCHING for the SMALL BROADCASTER

The convenience of push-button switching for program circuits has too often been considered a technical luxury for the small broadcast station. This article shows how the job may be done by the station staff at low cost

THIS article describes a pushbutton relay switching system free from clicks and positive in its action. While station engineers have varied ideas on this subject, it is hoped that this system will have application in those stations where, for one reason or another, the fader method is impractical and the high level system too costly.

Essentially a combination of series circuits, this system is entirely practical provided that the various components, especially the push button keys, are of good quality. This is important because circuit continuity depends on their making positive contact. For this reason it is strongly recommended that only the best grade of material be used. The fact that the foregoing is true is borne out by experience with the system at WBRY, Waterbury, Conn. This method of program switching was designed for that station by the writer in 1934 when he was associated with its development, and very little trouble has been experienced to date. A similar, but not quite so elaborate, arrangement is also in use at a Hartford station. Both will be described.

The fundamental circuit is shown in Fig. 1. The complete wiring diagram for the installation is shown in Fig. 2. Operation of the system (Fig. 2) is as follows: Let us assume that all buttons are off and all boards clear. The announcer or en-

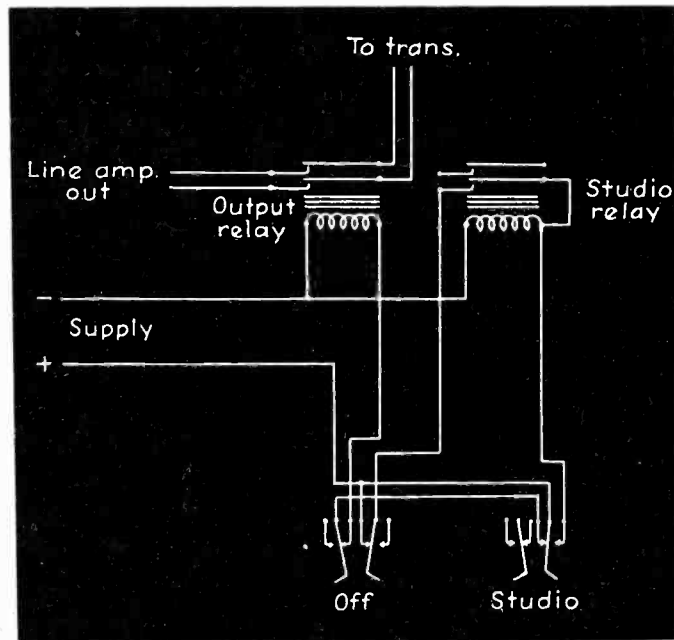

Fig. 1—Basic relay switching circuit

By HERBERT H. WOOD

*National Broadcasting Company, formerly with
WBRY, Waterbury, Conn.*

gineer connects the circuit for the next studio to take the program line which we will call studio A. As the button for this studio is depressed, it will be noticed that the inside or closed contact of the key opens before any connection is made between the center and the outside contact. This key is actually made of two single-pole double-throw switches with one side of each normally closed. Only one side is used. As this inside or closed contact opens, the field of relay X is broken allowing the relay to open. The contacts of this relay are connected between the output of the line amplifier and the

line to the transmitter. This opening momentarily lifts the line amplifier from the line, making it impossible for any click originating at its input, to reach the transmitter. As the button is depressed still further, the outside contact closes, energizing the studio A relay which is connected between the output of the A preamplifiers and the input to the program amplifier. A set of contacts on this relay are connected in a holding circuit so that the relay will stay closed. As the button is released the inside contact is again made and the output relay closes, completing program continuity through to the transmitter.

Concerning the circuit itself, it will be seen that the output relay coil has one side connected directly to the common or negative buss and the other side is series connected through the normally closed contacts of all of the push button keys. As only half of the contacts are used on the keys, it should be possible to wire both sets in parallel thereby doubling the safety factor. On the "off" key only, both sets of closed contacts are used so that when the button is depressed, not only does the output relay open, but the positive side of the holding circuit of the program relays is opened also. This, of course, clears the board. In other words, the holding circuit of all of the program relays is series-connected through all of the off keys and the output relay coil is

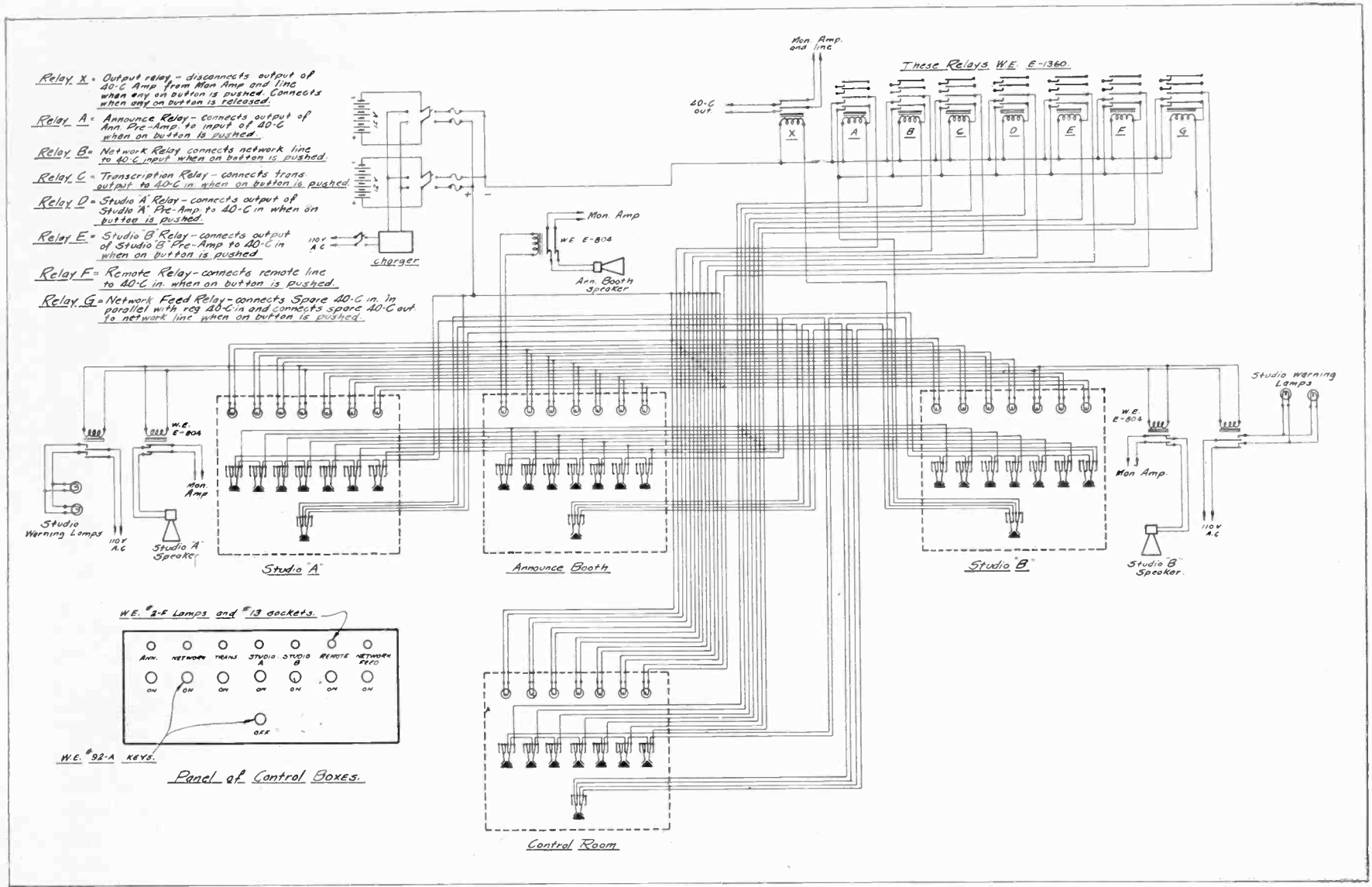

Fig. 2—The complete system, including control consoles for two studios, announce booth and control room. Standard telephone switches, lamps, and relays are used

series connected through all of the keys including the off keys.

At WBRY, four control panels were used and in addition to the main switching functions, it was considered necessary to have signal lights on the panels as well as "On the Air" and studio door warning lights. As for the lights on the panels, one side of each was connected directly to the negative buss and the other, through an extra set of contacts on the proper studio relay, to the positive side of the supply. Thus when studio A was punched up, the lamp directly over the A button on all of the panels was lighted and so on for each of the other buttons. The relays controlling the door and "on the air" lights were connected in parallel with the signal lights mentioned above and were energized in the same manner. In addition, a studio cue system was used whereby the announcer took his cue directly from the studio loudspeaker. To cut this speaker an

additional relay was wired in parallel with the lamp circuit, but having opening contacts instead of closing so that the speaker line opened when the circuit to the relay became energized.

The method of construction is simple and should offer no difficulty in installing a similar system. The individual panels, with the exception of the control room unit, were enclosed in suitable boxes and all of the equipment on the panel wired to a terminal strip in each box. These in turn, were wired to a main terminal board in the control room and all cross connecting done there. The control room panel was mounted on the main rack and wired directly to the main terminal strip. The relays were mounted at the top of the rack and fitted with dust covers.

Power was supplied from two sets of storage batteries so arranged that one set was always on charge. After about two years operation from batteries a rectifier was substituted

with no loss of efficiency. One thing to remember in choosing a rectifier is that good regulation is important. Otherwise the voltage will be high on those circuits having only signal lamp and relay—such as "remote" and "network."

At the Hartford station, the circuit details were followed, but the system trimmed down and simplified by the elimination of signal lights and other equipment not absolutely essential. Different push buttons were used but the standard of quality carefully maintained so that no difficulty has been experienced in the operation of the system.

The cost of such a program switching system should be about \$125.00 for parts and as the work can be done by the staff, the total should not be much greater. The system can be modified for any combination of amplifiers and studios and, if used properly, will be an extremely simple and positive method, as experience with it has proven.

An Experimental Duo-Pentode

Two pentodes for operation at radio frequencies have been constructed in a single envelope. An extensive system of shielding is used to reduce interaction between the two sections making it possible to operate the two sections in cascade at the same radio frequency

By

MAXWELL K. GOLDSTEIN

Naval Research Laboratory

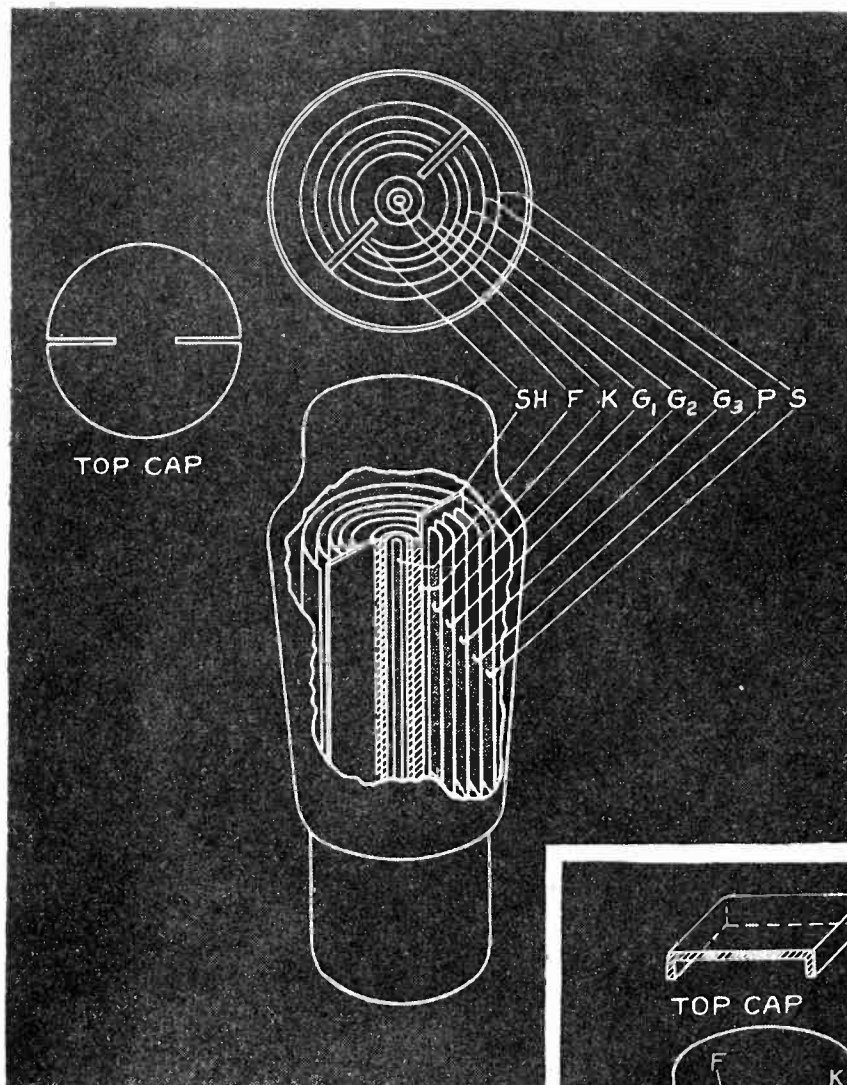

Fig. 1—Basic construction of the duo-pentode tube with circular electrodes. Shielding is obtained by the use of the shields *S* and *SH*

UNDoubtedly the most serious factor preventing the wide use of multiple-unit tubes is the undesirable interaction experienced between electrode groups. So objectionable is this interaction effect that such tubes are nearly always restricted to audio frequency applications or to uses where each electrode group operates in a different frequency range.

This paper reports a new and effective means employed to reduce

the interaction effect. For the common cathode type of duo-pentode tube shown in Fig. 3, the interaction effect was reduced to less than one per cent. Such low values of interaction extend the use of multiple-unit tubes to the radio frequency range and permit a maximum of operational flexibility, such as cascading, frequency-drag-free oscillator and mixer combinations, and the like, to be realized which heretofore have only been possible with two separate tubes. Multiple-unit tubes using these principles are further described in references 1 and 2.

Principles of Construction

Figures 1 and 2 show the basic construction employed to isolate two electrode groups of a duo-pentode tube. The metallic housing *S* in conjunction with the auxiliary electrodes *SH* and the cathode surface form two separate chambers each shielding and housing a triple grid electrode group. The shielding of the electrode groups is completed by the use of top and bottom metal caps and by the potential barrier setup by the auxiliary electrodes *SH*. A gap between the auxiliary electrodes and the cathode reduces the cathode-cooling effect while biasing of the auxiliary electrode minimizes electronic interaction between the electrode groups.

If Δe_{g1} represents an increase in voltage applied to g_1 (see Fig. 4) and if $-\Delta e_{g2}$ represents the decrease

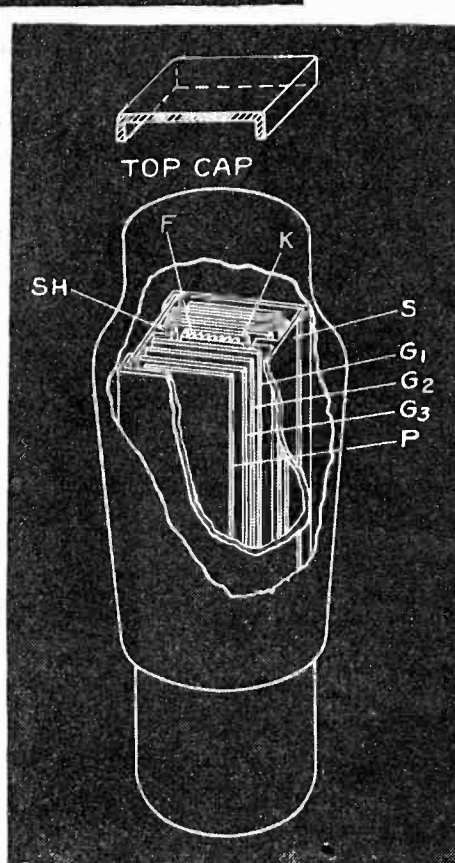

Fig. 2—Duo-pentode tube with plane electrodes. Shielding is similar to that of the tube with circular electrodes

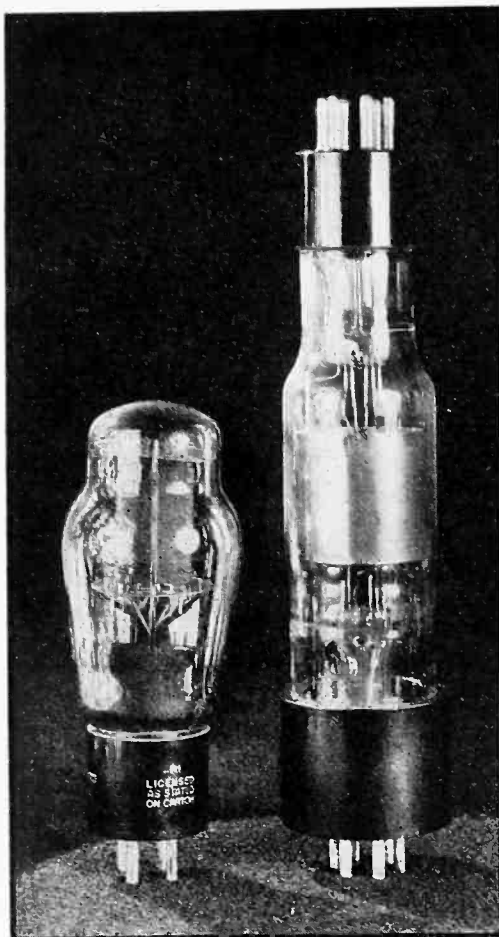

Fig. 3—The experimental duo-pentode tube compared with a conventional receiving tube

in voltage applied to g_2 necessary to keep i_p constant, then

$D_{12} = -(\Delta e_{g1}/\Delta e_{g2}) [i_p = \text{Constant}]$ is generally less than unity and can be interpreted as an interaction between g_1 and g_2 since Δe_{g2} can be viewed as an undesired voltage having the same effect on the plate current as the smaller quantity $D_{12}\Delta e_{g2}$ introduced on g_1 . This effect is called a shielding or "Durchgriff" effect in the literature and is expressed as $D = (g_{g2p}/g_{g1p}) = [(\delta i_p/\delta e_{g2})/(\delta i_p/\delta e_{g1})]$, See Reference 3.

In a similar manner, $D_{11}' = -(\Delta e_{g1}/\Delta e_{g1}') [i_p = \text{Constant}]$ represents the interaction between g_1 and g_1' .

D_{12}' , D_{13}' , and D_{1p}' are the other interaction factors between the tube sections. Because a given voltage applied to g_1' , has a greater effect on i_p than when this same voltage is applied to g_2' , g_3' , or p' , the interaction factor D_{11}' , is larger than D_{12}' , D_{13}' , or D_{1p}' . Figure 4 gives the measured values of D_{11}' as a function of grid bias E_{c1}' and auxiliary electrode bias, E_{sh} , for the tube shown in Fig. 3.

Power output triodes, pentodes, and hybrids (particularly those employed in class AB and B service)

do not completely solve the power output problem. While Class A operation of triodes is capable of high quality (linearity of transmission) its power sensitivity is poor. The pentode in Class A operation is high in power sensitivity but poor in quality. The hybrids in general are high in efficiency, but suffer in quality and in power sensitivity.

Auxiliary Electrode Control of Quality

The quality of transmission of a tube is governed by the constancy of its characteristics with control grid input voltage with the most important variation being the transconductance, g_{g1p} . The relatively compared curves of Fig. 5 show that the triode transconductance is more constant with input voltage than the pentode and explains why the triode is generally employed with high level inputs while the pentode is generally employed with low level inputs, in those applications where linearity of transmission is important. The other curves of Fig. 5 represent the transconductance characteristic of one section of the duplex tube of Fig. 3 operating as a pentode, and it is of interest to observe a progressive improvement

in constancy of its transconductance characteristic with control grid voltage as the auxiliary electrodes are increased in positive potential. As the transconductance constancy improves with increasing auxiliary electrode positive bias, a similar constancy improvement occurs for the plate conductance, and simultaneously, both the transconductance and the conductance increase with the auxiliary electrode bias. All of these characteristics are essential for high power sensitivity and high quality operation of power output tubes. Due to their being out of the path of the space current, the auxiliary electrodes (at plus 12 volts) draw but a fraction of the total space current. Operation beyond plus 12 volts is undesirable due to the emission of secondary electrons from the auxiliary electrodes.

Improvement in power output performance by the use of positive potentials on the auxiliary electrodes bears a significant similarity to the improved power output performance obtained by means of auxiliary electrodes of the beam power tube⁵ and the equivalent critical distance tube.^{6,7} Work on the latter tubes is believed to have been

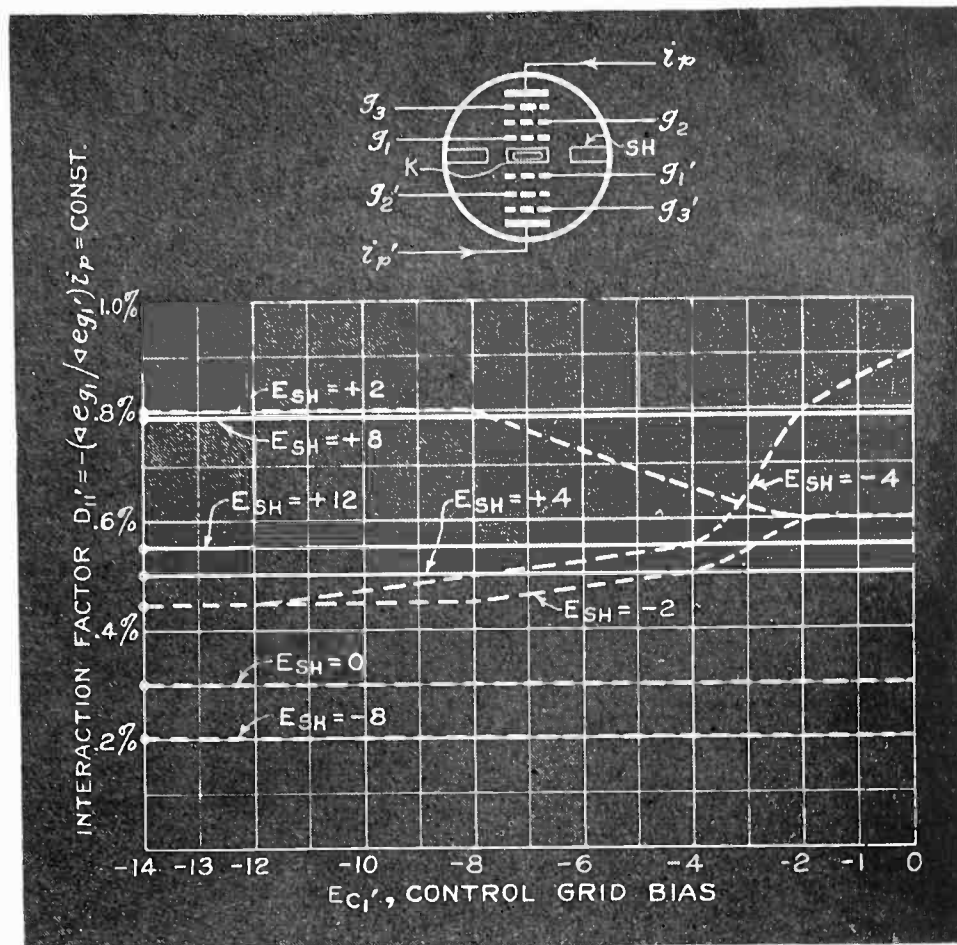

Fig. 4—Interaction factor between pentode sections as a function of the control grid bias and the shield voltage

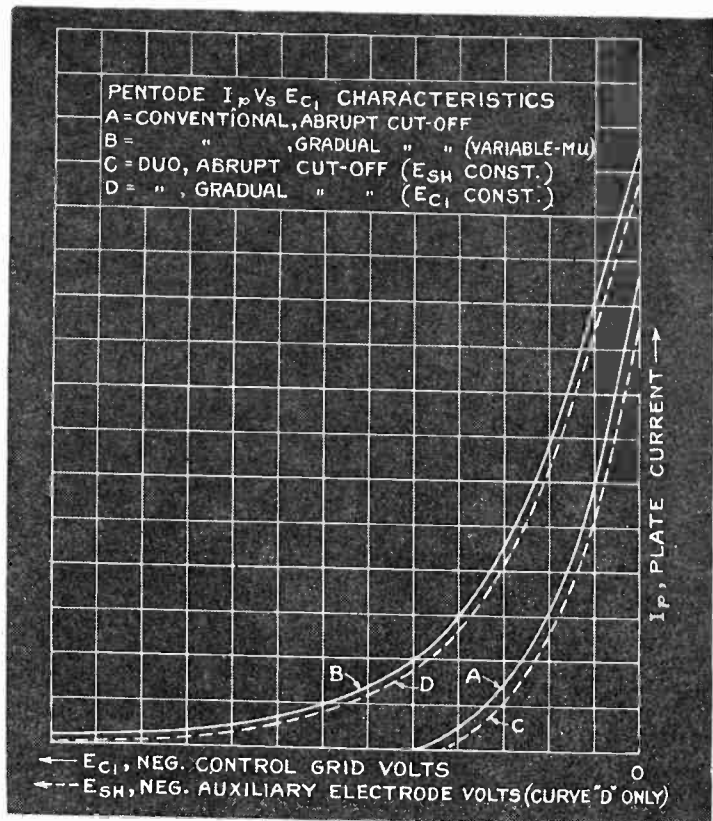
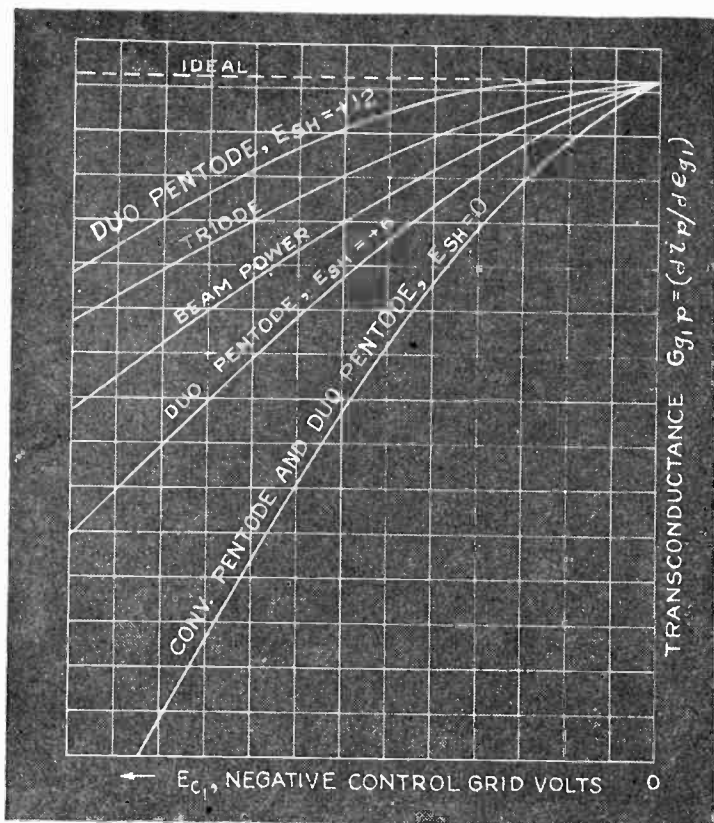

Fig. 5 (Left)—Comparison of linearity of characteristics using various types of output tubes. Fig. 6 (Right)—Comparison of plate current cutoff characteristics. Note that the same duo pentode tube operates at either abrupt or gradual cutoff

first published some time after the duo-pentode shielding investigations were first reported.^{1,4}

Auxiliary Control of Cut-Off

Curve C of the relatively compared curves of Fig. 6 shows how a pentode connection of one section of the duo-pentode tube yields an abrupt plate current cut-off characteristic when the auxiliary electrode bias, $E_{sh} = 0$, or some constant negative value. Curve D shows the gradual plate current cut-off characteristic that is obtainable from the same tube by merely varying the negative bias of the auxiliary electrodes. In the practical variable-mu operation of this tube, the negative bias is conveniently obtained from the a-v-c circuit to vary the stage gain. The ability to obtain either an abrupt or a gradual plate current cut-off characteristic from a tube of fixed construction eliminates the need for two distinct tubes.

Practical Applications

The low interaction factor, the auxiliary electrode control of power output and quality, and the auxiliary electrode control of the plate current cut-off characteristic obtainable with the duo-pentode tube makes this tube fit a variety of applications, each of such applications being heretofore reserved for special purpose

tubes. It is probable that the unusual flexibility of operation permitted by this type of duplex construction will make it particularly desirable for use as a universal type of tube. The feasibility of internally connecting the screen and suppressor electrodes combined with the use of a common filament and cathode permits sufficient simplification of external connections so that a single socket of the octal type plus a top cap is adequate. Reference 2 shows an attempt to use these shielding principles for the control of gaseous types of multiple-unit tubes, while Reference 4 gives a detailed study of the duo pentode and its practical applications.

Conclusions

1. The shielding design used in the duo-pentode tube results in interaction factors (between electrode groups) of less than one per cent.
2. The low values of interaction obtainable permit great flexibility in operating the duo-pentode tube at audio and radio frequencies, cascade operation at radio frequencies being readily realized.
3. Operating the auxiliary electrodes at positive potentials permits a marked improvement in power output and quality of pentode tubes.
4. Operating the auxiliary electrodes at negative potentials per-

mits an electrode group of fixed construction to have either an abrupt or a gradual plate current cut-off characteristic. This optional feature may eliminate the necessity for manufacturing two distinct tube types where one will suffice.

5. The shielding principles used in the duo-pentode tube are extendable to multiple-unit tubes and may be advantageously employed in multiple-unit gaseous tubes.

The author wishes to express his appreciation to Professor J. B. Whitehead, Professor Kouwenhoven, and Dr. Ferdinand Hamburger, Jr., of the Johns Hopkins University School of Engineering and Mr. Allen B. DuMont for their encouragement and assistance during the investigation of this work.

The opinions contained herein are the private ones of the author and are not to be construed as Official or reflecting the views of the Navy Department or Navy Service at large.

BIBLIOGRAPHY

- ¹ M. K. Goldstein, "Electron Discharge Device," U. S. Patent No. 2,052,617; Sept. 1, 1936, (application date Feb. 14, 1933.)
- ² M. K. Goldstein, "Color Transmission," U. S. Patent No. 2,184,075; Dec. 19, 1939.
- ³ E. L. Chaffee, "Theory of Thermionic Vacuum Tubes," Text, Chapter XXIII, pp. 588.
- ⁴ M. K. Goldstein, "A Duplex Triple Grid Tube with External Control of Its Characteristics," Dissertation, 1933, Johns Hopkins University.
- ⁵ O. H. Shade, "The Beam Power Output Tube" described before N. Y. I.R.E. section April 1, 1936. Also separately reported by J. F. Dreyer, Jr., in ELECTRONICS, Vol. 9, 1936, pp. 18-21 and 35.
- ⁶ J. H. O. Harries, "Critical Distance Tubes," ELECTRONICS, Vol. 9, May, 1936, pp. 33-35.
- ⁷ J. H. O. Harries, "A New Power Output Valve," Wireless World, Vol. 37, August 2, 1935, pp. 105-106.

A Sensitive Frequency Meter for the 30 to 340 Megacycle Range

A simple, rugged and highly sensitive absorption type frequency meter, for the ultra-high frequency range, is here described. The crystal detector resonance indicator is coupled to the condenser shaft, thus avoiding direct pick-up from the generator source

By E. L. HALL

United States Bureau of Standards

THIS paper describes a precise and very sensitive frequency meter covering a range from 30 to 340 megacycles per second. The meter consists of a variable condenser, coils of sturdy construction, and a resonance indicator. The condenser and resonance-indicating system are mounted within a metal box for shielding. The resonance indicating system consists of a 20-microampere d-c meter, a special type of fixed crystal rectifier and a coupling conductor, connected in series.

The sensitivity of the instrument is such that very loose coupling to an oscillator must be employed. For example, a large deflection is obtained several feet from a 65-Mc oscillator using an acorn tube and an input of 0.25 watt. With suitable generators, harmonics including the eighth have been indicated. The meter has the advantages of extreme sensitivity, great precision of measurement, ready portability, and no batteries or tubes.

Increasing use of ultra-high frequencies makes methods and instruments for quickly and precisely measuring these frequencies of considerable interest to workers in this field. This paper gives a description of a sensitive and precise frequency meter covering the range from 30 to 340 megacycles per second.

While frequency meters of the heterodyne type are very precise and useful below and within the range here mentioned, they do not



Fig. 1—External appearance of the meter. A rugged two-section capacitor is used with the coils shown to cover the 30 to 340 megacycle range

offer a quick, reliable method of measuring the frequency, for example, of an unfamiliar oscillator. This is because heterodyne response will be obtained not only at harmonics of the oscillator but also at subharmonics, or when the frequencies of the heterodyne frequency meter and of the oscillator bear ratios of simple whole numbers.¹ A simple absorption type frequency meter is indispensable for quickly measuring the fundamental frequency of an oscillator. While small indications may sometimes be obtained on the second or third harmonics of

the generator, trials of the frequency meter through a frequency band including one-half and one-third these indicated frequencies will quickly show whether one of these is the fundamental frequency.

The frequency meter to be described, shown in Fig. 1, is of the absorption type, but with improvements making for increased accuracy, precision, and reliability. The author has had the opportunity, for an extended period, of examining and testing frequency meters of various types and noting their advantages and faults. Advantage was

CHARACTERISTICS OF COILS

Coil	Inside diameter, inches	Number of turns	Frequency range, megacycles Terminals BC	megacycles Terminals AB
1	2 1/16	4	29-52	41-68
2	2 1/16	1	71-136	101-192
3	3/4	1/2	100-195	140-280
4	...	link	135-260	200-344

taken of this opportunity to improve the design and avoid some undesirable features found in certain of the instruments submitted for test.

While the frequency meter, originally known as a cymometer^{2, 3} and as a wavemeter, is one of the first instruments used in radio measurements, several descriptions^{4, 5, 6} of instruments of improved design have appeared recently, indicating continued need for this instrument. Some of the factors to be considered in the design of a frequency meter for ultrahigh frequencies will be presented.

Descriptions of frequency meters^{7, 8, 9} developed for use at the National Bureau of Standards have appeared at several times, but while these more than covered the ranges required for calibration and measurement work at the corresponding times, the range has continually been extended to higher and higher frequencies. Need was felt some years ago for an instrument to extend the range from 40 megacycles per second upward. Accordingly, an instrument was constructed in 1935 using a smaller condenser and smaller coils than those used previously. It was built using an inductively coupled resonance indicating circuit employing a crystal detector and a 200-microampere d-c meter, which was the most sensitive small portable instrument conveniently available at that time. This frequency meter had a range from 27 to 300 megacycles per second, but the upper hundred megacycles was on a coil too small for convenient operation. This fault was not important at the time, because no measurements in that range were required. However, it served to point out the desirability of a condenser of smaller capacitance, the use of leads of minimum length connecting condenser and coil, and the use of a more sensitive indicating instrument. It is interesting to note that recent frequency checks made

on this frequency meter were in excellent agreement with calibrations made four years ago. This is gratifying because it was feared that the hard rubber strips used to support the fixed plates of the condenser might have warped and caused a change in calibration.

The improved frequency meter was made up using better parts than were previously obtainable. In order to reduce the possibility of capacitance change caused by deformation of the plates or their supports, a condenser with wider than usual plate spacing, a two-section stator, and ceramic stator supports was used. Each section had a capacitance of 35 micromicrofarads. The plate shape was such that the frequency versus condenser setting curve approximated a straight line.

these frequencies because of additional resonance responses shown by the sensitive resonance indicator and thought to be caused by the various combinations of inductance and capacitance presented.

Inductance was present in five places: the main coil, the jumper strip, the mutual inductance of the two, the condenser leads, and the inductance of the condenser shaft. The mounting of the condenser within a metal box and the position of the two sections of the condenser near each other introduced other capacitances than those in the two sections, which were effective in increasing the total capacitance. These additional responses were spurious, but were not noted for the single section or two sections in series after removing condenser parts which had increased the capacitance between the two sections, and after changing the connection to the grounded condenser rotor so that the minimum length of the condenser shaft was in use.

A 20-microampere d-c ammeter having a resistance of approximately 1500 ohms was used as the resonance indicating instrument.

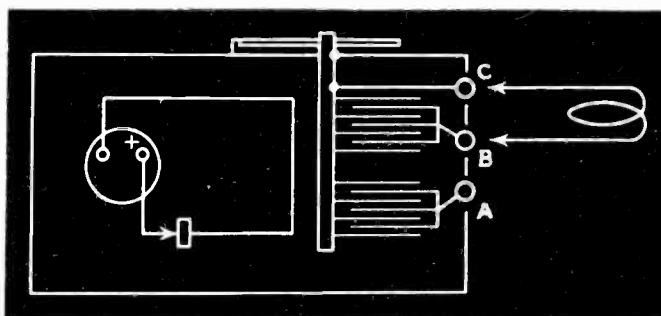

Fig. 2—The circuit diagram of the instrument. The coil may be plugged in to one section of the capacitor or to two sections in series, depending on the range desired

The use of a single section of the condenser and of the two sections in series, as in the previous model, was continued because it extends the range of a given coil, and affords check points over a part of this range. The condenser terminals were brought out through connectors of minimum length to jacks mounted on low-loss insulating material to receive the plugs of the coils. Terminals were also provided so that the two sections of the condenser could be placed in parallel by means of a 1/4-inch jumper strip. Such a connection would extend the range of a coil to lower frequencies, but was found to be undesirable at

Following past custom, a one-turn coupling coil was placed in fixed relation to the coil of the frequency meter. Under certain conditions a direct coupling with the generator was observed, but this usually could be eliminated if desired by changing the distance to the generator. It was also thought that part of the spurious indications might be caused by interaction between the frequency meter circuit and the resonance indicator circuit. This was quite definitely proven not to be the case, but led to the removal of the external coupling coil, and its inclusion within the metal case in a

(Continued on page 91)

AUDIO AND VIDEO ON A SINGLE CARRIER

By frequency modulating during the synchronizing pulses, at audio frequencies, it is possible to transmit the sound part of a television program on the same carrier as the picture. The upper frequency limit of the audio reproduction is 7875 cycles per second for a 525-line 30-frame picture

By H. E. KALLMANN

Scophony, Ltd., New York

SINCE a television program consists of picture and accompanying sound transmission, there are two complete transmitters and antenna systems. At the receiver side, the antenna and the first stages are usually common to both channels. This requires that both carriers be on adjacent wavelengths and—especially in the vestigial sideband systems adjacent carriers are so close together that good filters are necessary to prevent the audio carrier from causing a beat pattern in the received picture.

Evidently, a scheme to transmit both the audio modulation and the video modulation on a single carrier is desirable. Apart from eliminating one transmitter and antenna system, space in the ether is also used more economically since pictures of higher definition can be sent in a given channel if the video signal may fill the whole program channel.

The most obvious scheme is based on the fact that for a considerable fraction of time no video signals are transmitted by the usual television transmitter, because the deflection system has inertia. Thus, a time interval must be allowed after each line and after each frame for the beam to return to its starting point. This "fly-back time" is partially occupied by the synchronizing pulses. It is conceivable to use these pulses, which extend above the black-level, for transmission of sound modulation by modulating their

amplitudes. All frequencies lower than one-half the line-pulse frequency can thus be transmitted. A keying system in the receiver may be devised which, synchronized by the horizontal deflection generator, delivers a pulse which simultaneously blacks out the return line on the screen and opens the path to the sound amplifier during every fly-back time. An evident disadvantage of this scheme is that timing pulses of unequal height reach the synchronizing level after varying de-

lays, making for uneven synchronization. Furthermore the scheme remains impracticable since it presupposes faultless reception of synchronizing signals. Even a momentary break of synchronism will result in intolerable noise.

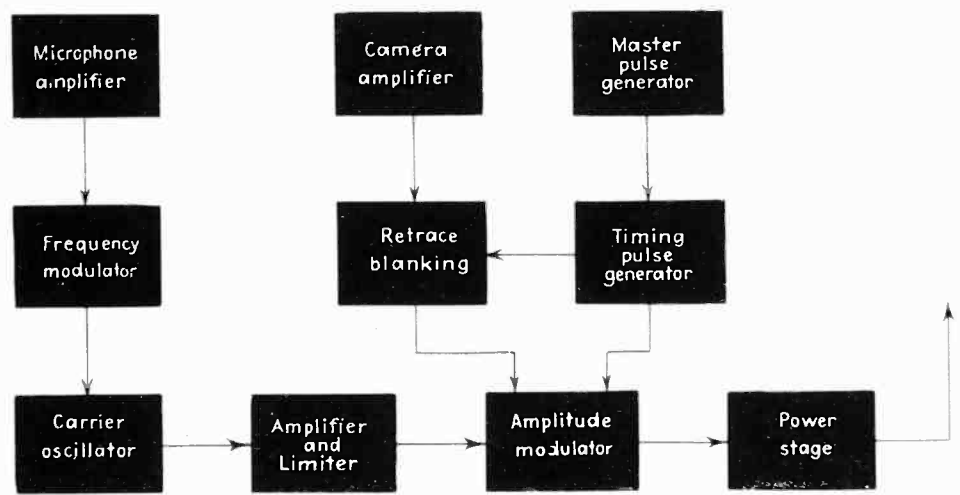
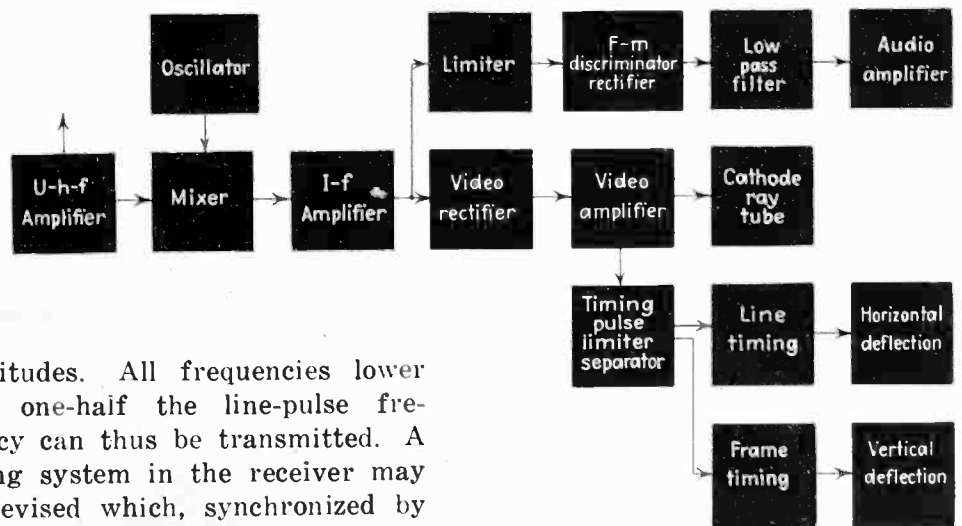

Fig. 1—Transmitter for frequency modulating the carrier continuously at audio frequencies, while amplitude modulating at video frequencies

Fig. 2—Block diagram of a receiver suitable for the transmitter outlined in Fig. 1. The system suffers because double sideband transmission must be used



Another scheme¹ proposes to assign different types of modulation to the video and audio signals, for example amplitude modulation to the video signals, frequency modulation to the audio signals. Thus, the carrier oscillator of the transmitter, shown in Fig. 1, is first frequency-modulated with the audio modulation, perhaps with a maximum excursion of ± 0.1 megacycle. The modulated carrier is amplified, limited to suppress all traces of amplitude modulation and then amplitude modulated with the video and timing signals. The rest of the transmitter and the video channel in the receiver are conventional as shown in Fig. 2. If the overall frequency response of the transmitter and the receiver can be taken as substantially flat over the entire video frequency band then the relatively small variation of the carrier frequency will not affect the video signal.

The audio channel is tapped off the video channel in the receiver between the i-f amplifier and the video rectifier, from which point the signals are fed to a limiter. How-

ever, the amplitude of the signals will occasionally be zero. This will occur, with negative modulation during full white, or with positive modulation during the timing pulses. With positive modulation the signals, which leave the limiter limited to below the black level, are free of amplitude modulation except for the gaps caused by the line and frame timing pulses. The former will appear as audible signals in the audio amplifier but they are easily suppressed in filters, the latter will be inaudible if they are made short.

In a modification of this scheme, both the line and the frame timing pulses are made readily removable by transmitting them as the envelopes of two subcarriers. These subcarriers and their sidebands are outside the frequency range of the frequency modulation and can thus be suppressed by frequency filtering. Receiver is outlined in Fig. 4.

The fundamental disadvantage of this scheme is that it assumes double-sideband transmission, therefore is not, as far as space occupied in the ether is concerned, superior

to present practice of single-sideband transmission. In a single-sideband system the frequency modulation would be converted into amplitude modulation by the single-sideband filter.

Separation in Time and by Type of Modulation

A scheme which avoids the limitations of the foregoing methods can be found by taking some features of each. Following the first scheme, the audio information is transmitted only during the fly-back intervals of the picture transmission. Following the second scheme the separation of the timing pulses from the audio signals is accomplished by utilizing different types of modulation.

Referring to Fig. 5, the transmitter may then be operated in entirely different and independent ways during the picture periods (marked *P*) and the sound periods (marked *S*). The video signals, during the periods *P*, may either be conveyed as negative amplitude modulation or as frequency modulation, as double- or vestigial-sideband transmission. The audio signals are transmitted only during the retrace intervals *S*, as frequency modulation of the line timing pulses. This sets an upper limit to the audio channel at one half the frequency of the line timing pulses.

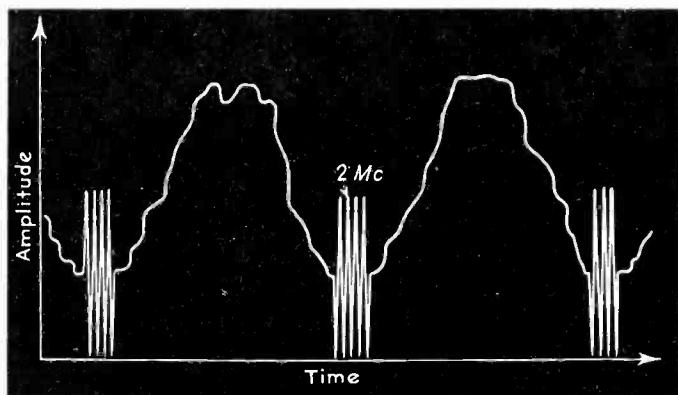
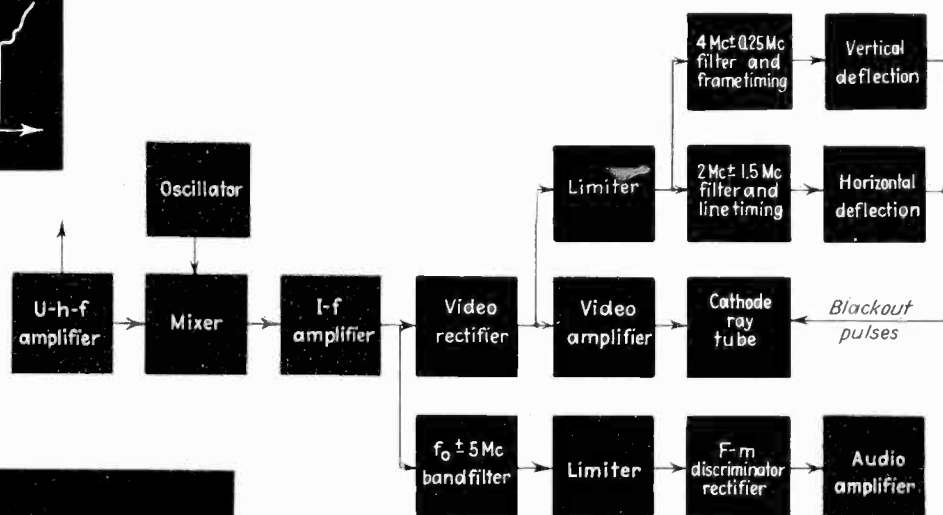
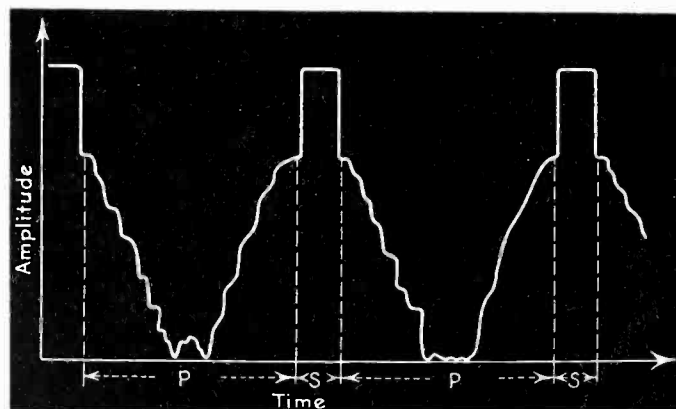

Fig. 3 (Left)—A system of frequency modulating a sub-carrier during the blanking interval

Fig. 4 (Right)—A receiver for receiving audio and video signals on a signal carrier, with audio frequency-modulating a sub-carrier

Fig. 5—Basic negative modulation video waveform, showing picture period (*P*) and sync-sound period (*S*)



The line and frame timing pulses are of constant height, extending above the black level, and are separated from the picture signals by amplitude selection in the receiver; but they occupy different frequency ranges so that frequency selection after the amplitude selection will

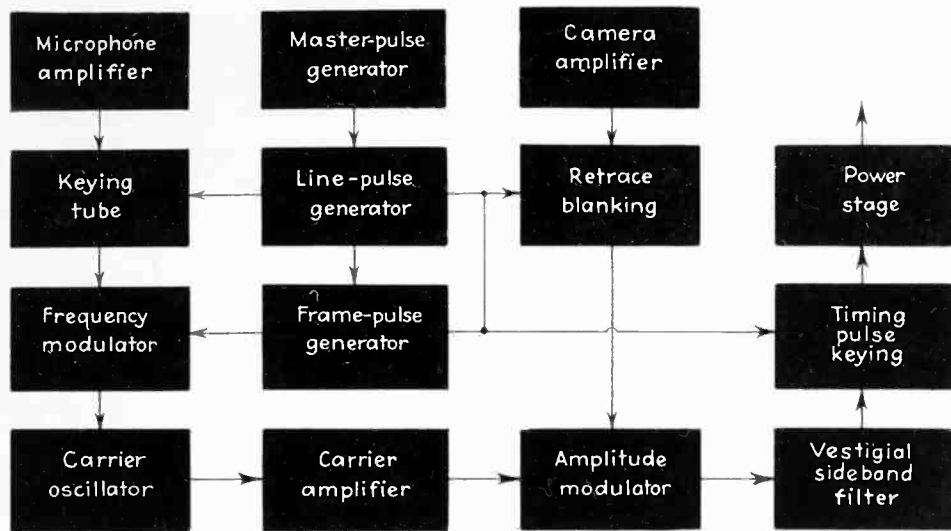

Fig. 7—Transmitter for carrying out the fundamental scheme, with frequency modulation for the audio restricted to the sync signal intervals

differentiate between them. This measure will also exclude the frame timing pulses from the discriminator circuit which serves to extract the audio modulation from the frequency-modulated line timing pulses. The loss in signal-to-noise ratio in the sound, due to its being transmitted only 10-15 per cent of the time is made up by allotting a very wide frequency swing.

Thus, a frequency spectrum such as shown in Fig. 6 results, in which the solid lines may represent the overall response of the vestigial sideband transmitter and receiver for the picture signals during the periods *P*. The broken lines show an example of the overall response of transmitter and receiver during the flyback intervals *S*. Curve I represents the band allotted to the line timing pulses, extending perhaps from $f_c - 1$ Mc to $f_c + 2$ Mc, where f_c is the carrier frequency of the picture modulation. This band of 3-megacycle width yields timing pulses of ample steepness and yet allows for frequency modulation over a frequency range of ± 1 megacycle. The Curve II is that allotted to the frame timing pulses, providing a band ± 0.5 Mc at $f_c + 3$ Mc. These pulses are sent during the *P* periods, lasting perhaps 25 per cent of the line scanning period, starting 5% after a line in even fields, 55% in odd fields.

Before discussing interactions between these signals, a suitable system may be outlined. Fig. 7 shows a transmitter in which the frequency of the carrier oscillator is modulated by the frame timing pulses, excursion +3 megacycle; and by the audio modulation, ± 0.5 megacycle, about a midfre-

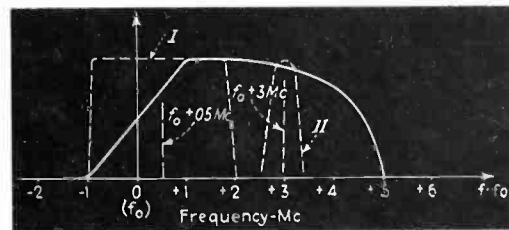
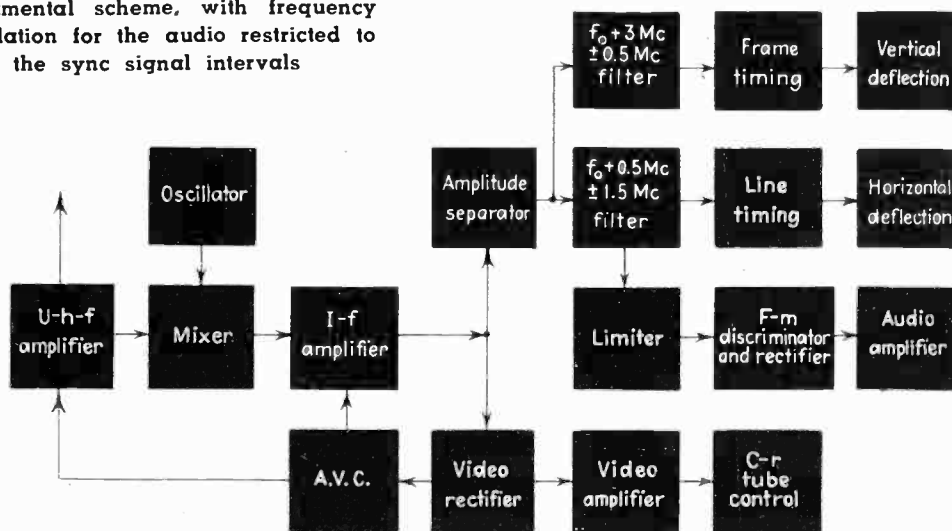

Fig. 6—Frequency spectrum which arises from the use of frequency modulation of the sync signals, to carry the audio signal

Fig. 8—Receiver for the transmission system outlined in Fig. 7. The only limitation is that the upper audio limit is equal to one half the line scanning frequency



quency $f_c + 0.5$ Mc, but only for the duration of the line timing pulses when this path is keyed open by the line timing pulse generator.

After amplification, the amplitude of the carrier is limited to suppress all spurious amplitude modulation and then amplitude modulated by the video signals. The signal then passes through a vestigial sideband filter whereupon the amplitude is again keyed by the combined output of the two timing pulse generators. At this stage, the amplitude of the timing pulses is raised above the black level and clipped at a constant height.

Figure 8 outlines the corresponding receiver. The u-h-f, mixer and i-f stages are of conventional design, passing frequencies from $f_c - 1$ Mc to $f_c + 3$ Mc with approximately constant gain, thence to nearly $f_c + 5$ Mc with slowly dropping gain. The output of the i-f amplifier is split up as follows:

1. The signal is fed to a video rectifier of conventional design, thence to a video amplifier and to

the control electrode of the cathode-ray tube. The d-c component of the rectifier output is fed to the a-v-c system.

2. The signal is fed to an amplifier tube which is biased so far beyond its sharp cutoff that it responds only to the high amplitudes extending above the black level, that is, to all the timing pulses. In the anode circuit of this tube are thus found pulses which may be separated by frequency selection.

3. The band from $f_c + 2.5$ Mc to $f_c + 3.5$ Mc is filtered out by a resonant circuit, rectified and the resulting pulses fed to the frame timing circuit which triggers the vertical deflection system.

4a. The band from $f_c - 1$ Mc to $f_c + 2$ Mc is also rectified and the resulting pulse envelope fed to the line-timing circuit which triggers the horizontal deflection system.

4b. The same band is also, perhaps after further amplification, fed to a limiter, thence to the f-m discriminator circuit, to a rectifier, a low pass filter cutting at one half the line

pulse frequency and to the audio amplifier and loudspeaker.

In the system outlined, involving vestigial sideband filters, simultaneous frequency and amplitude modulation, as well as frequency and amplitude separation, superficial inspection cannot make it clear whether interaction between the various signals is to be expected. Yet the following brief analysis may show that the situation can be resolved into a few familiar problems with known solutions.

It is helpful to remember that no two signals can interfere with each other unless they are simultaneous. Thus there can be no interaction during the picture periods P (Fig. 5) since during these the video modulation alone is transmitted.

nomena is excluded by ample intervals of at least 0.05 the horizontal scanning period.

The sideband frequencies of the frame timing pulse are restricted to about ± 0.5 Mc, therefore cannot penetrate into the frequency range reserved for the line timing pulses. Yet this bandwidth permits the frame timing pulse to rise from 0.1 to 0.9 of its final height in just over .01, the horizontal scanning period, though a rise one tenth as fast would suffice for accurate interlace.

The line timing pulses during moments of silence, when the carrier is at $f_0 + 0.5$ Mc, may occupy a band of 3 megacycles width. Thus the front of the rectified line timing pulses may rise from 0.1 to 0.9 final height in about 0.30 microseconds.

plies to the pulses in the plate circuit of the amplitude selector tube —is replotted from Stanford Goldman's solution to this problem² in Fig. 9. Curve I shows the case when the carrier is in the center of the band, Curve II the carrier is 0.75 megacycle from one shoulder of the band, 2.25 from the other end, a much greater excursion than assumed in this scheme, yet the two curves fall on top of each other all the way from 0.1 to 0.9 of the final height. This result agrees with unpublished observations of the author, carried out on a single resonance circuit as a single-sideband filter.

Change of the carrier frequency during the time of a pulse can be neglected, since the pulses are short compared with the period of the highest sound frequency.

The effect of the line timing pulse on the sound modulation, that is, the fact that the sound transmitted only during discrete short bursts of a frequency-modulated carrier must be investigated. The pulses, limited to equal height, will produce in the frequency discriminator circuit bursts of oscillations of a height varying in linear proportion to the frequency of the carrier. The output of the rectifier thus contains, apart from the i-f carrier frequency and sidebands, not only the envelope of these pulses, the sound modulation, but also the pulses themselves. These pulses represent a subcarrier amplitude-modulated by the audio modulation. They are somewhat unusual in that there are also present many strong harmonics of the subcarrier, but they are all of higher frequency and do not interfere. However the lower side-band of the subcarrier frequency is apt to extend down to audible frequencies. In fact, in all cases where the audio modulation contains frequencies above one half of the subcarrier frequency (above 7875 cycles per second for a 525-line, 30-frame picture), the audio band and the lower sideband will overlap. Thus a higher line frequency (as is required for color television) is wanted if higher sound frequencies are to be transmitted.

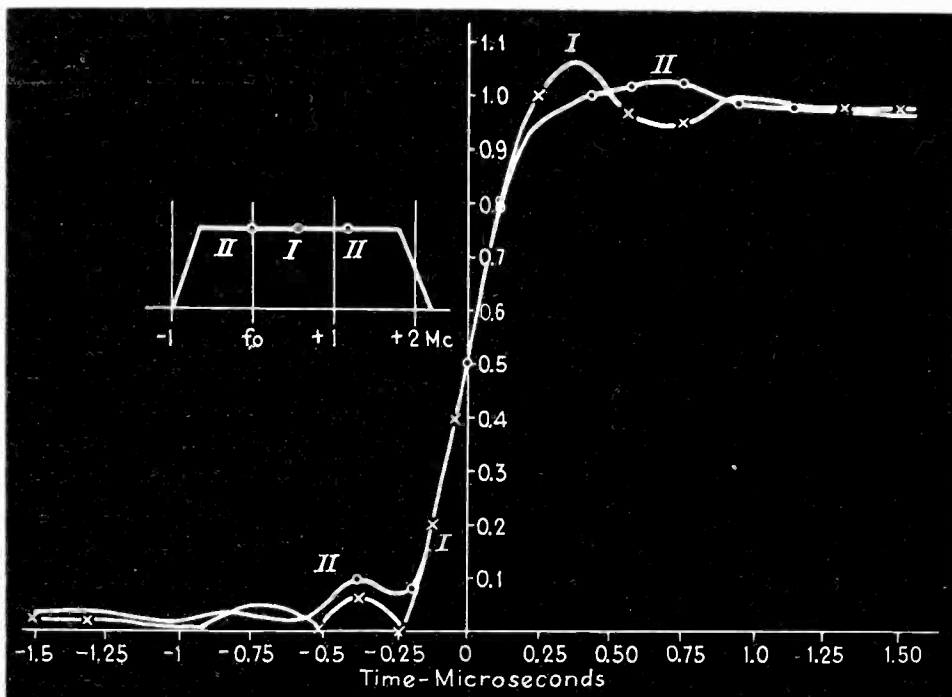

Fig. 9—Analysis showing the time of rise of the leading edge of a sync pulse for different carrier positions (after Goldman)

During the transmission of the timing pulses, the video rectifier receives signals of constant height and varying carrier frequency. All these pulses are rectified equally well, yielding blacker-than-black pulses suitable for blacking out the retrace of the beam.

As stated above, there is no trace of picture signals left in the anode circuit of the amplitude selector tube, only line and frame timing pulses. Any interaction between them, such as cross modulation in the non-linear cutoff region of the amplitude selector tube, is ruled out since these pulses never occur at the same time; overlap of transient phe-

This steepness of front compares well with the present R.M.A. standard requiring the pulses to rise to their final level in 0.005 of the horizontal scanning period.

However, the carrier of the line timing pulse will seldom be at the center of the allotted band, swinging up to ± 0.5 megacycle with the audio modulation. It is to be suspected that the front of the pulses may depend, in steepness and shape, on the momentary position of the swinging carrier in the band. Such an effect theoretically exists, but it is fortunately very small. The shape and position of the pulse front for 100 per cent modulation—as ap-

¹ H. E. Kallmann and E.M.I. Ltd. Brit. Appl. 6123-39.

² Stanford Goldman, Television Detail and Selective Sideband Transmission, *Proc. I.R.E.* Vol. 27, No. 11, Nov. '39, pp 725-732, Fig. 5, curves 1 and 2.

Since the change in light intensity is small, the amplifier must have high gain, and in order that it reproduce the diagram faithfully at slow engine speeds the low-frequency response must be linear to 10 cycles per second. The very high frequency response should also be reasonably linear in order that the high frequency waves on the diaphragm due to detonation be faithfully reproduced (which is important when knock properties of various fuels are investigated).

The amplifier of Schade¹ meets the above requirements, and with the addition of a pre-amplifier stage as indicated in Fig. 2 has operated satisfactorily in this service. The amplifier output is connected directly to the deflection plates of a type 171 Du Mont Oscilloscope, and synchronism of the sweep circuit is maintained by means of a contact and commutator directly connected to the engine shaft.

A diagram of rate of pressure change is frequently desirable, especially when detecting knocking, and this feature has been provided for by coupling condenser C_s , which has been made variable in ten steps. As this condenser is decreased in capacity, the lower frequencies are not amplified so that the amplifier responds only to those frequencies which represent rapid changes in pressure, thus effectively differentiating the pressure diagram.

Dielectric Constant Apparatus

The dielectric constant equipment (Fig. 3) was built for laboratory use, chiefly in analysis, but has indicated the possibilities of similar equipment for control purposes.

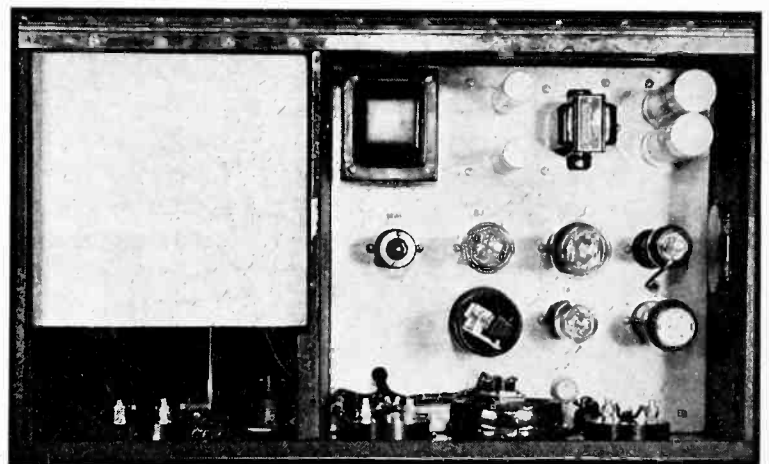
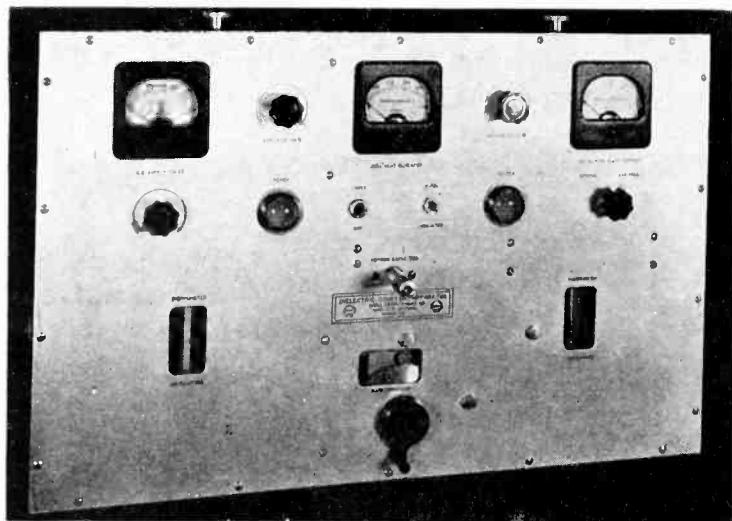

Fig. 3—Equipment for measuring dielectric constants. The overall accuracy is within 0.1 per cent

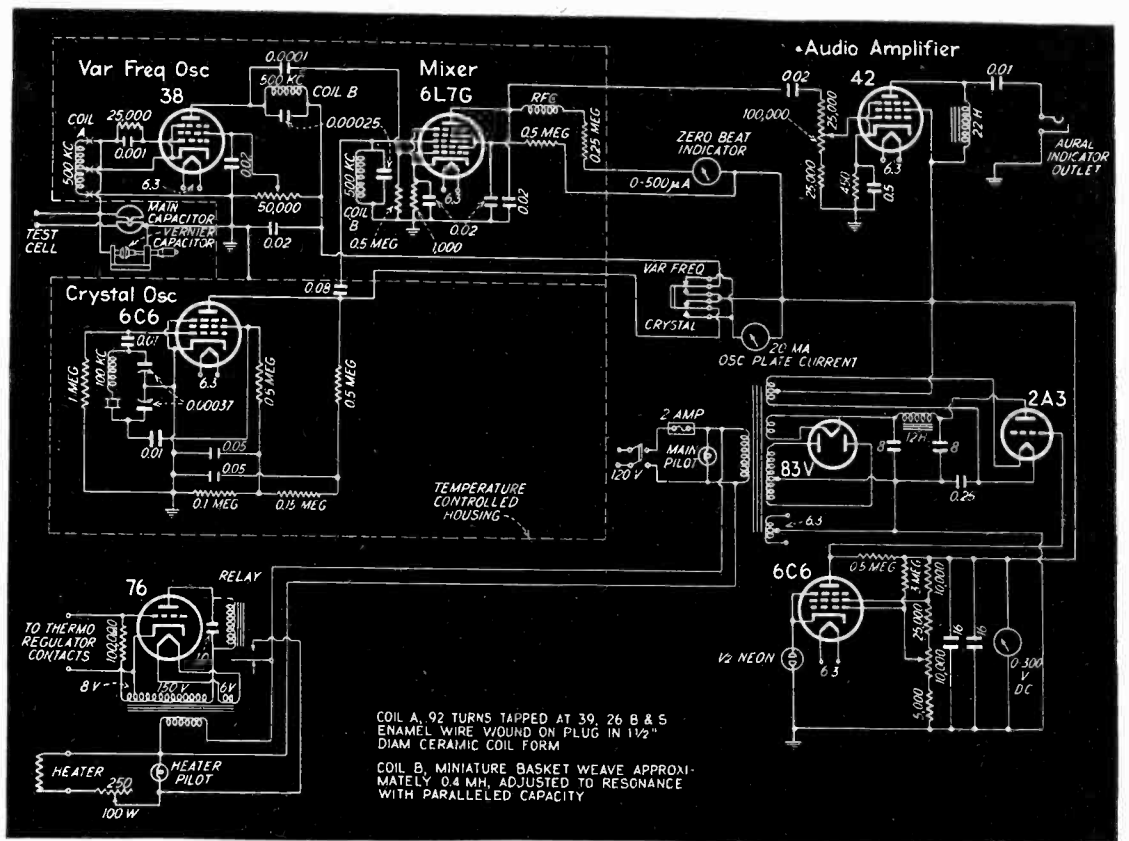

Fig. 4—Circuit diagram of the dielectric constant measuring apparatus. The capacitance of a test condenser is measured (at any of a number of frequencies) with and without the dielectric from which the dielectric constant is easily calculated

Since it was desired that the instrument be as flexible as possible and allow for measurements at several frequencies, a 100-kilocycle quartz crystal was used as the fixed frequency oscillator in a circuit rich in harmonics. This enables measurements to be made at any frequency which is a multiple of 100 kilocycles, up to about 1000 kilocycles, by making the necessary change of variable frequency oscillator tank inductance. The normal operating frequency was chosen as 500 kilocycles.

The variable frequency oscillator is tuned by a calibrated condenser

and test cell in parallel. It is thus easily possible to obtain the capacity of the test cell with and without the dielectric under test, and from the ratio of the former to the latter, the dielectric constant. A vernier capacity, which can be read to 0.05 micro-microfarad, is provided for measuring very small capacity differences.

In such apparatus the usual method of tuning the variable oscillator to the measuring frequency is by aurally obtaining a zero beat between the audible beat of the oscillator and a tuning fork. Because this method requires a tuning fork

with a closely controlled frequency and is also fatiguing to the operator, it was decided to use zero beat between the oscillators as a reference. A 500-microampere d-c meter in the anode circuit of the mixer tube (type 6L7) serves very well to indicate beat frequencies below audibility to absolute zero beat. The complete circuit diagram is given in Fig. 4.

Particular care was used to isolate the two oscillators from each other, and their outputs were fed into the No. 1 and No. 3 grids of the mixer tube. There is no tendency for the circuits to lockin. They will maintain a beat frequency of less than 1 cycle per second for several minutes. The oscillator assembly, Fig. 5 is housed in a copper cylinder which is temperature controlled to ± 0.1 degree C., and supplied with regulated electrode voltages.

The ten-hour stability of the variable oscillator, compared to the crystal oscillator, is about ten parts per million and the over-all accuracy of measurement is within 0.1 per cent which is the condenser manufacturer's calibration accuracy. While the temperature coefficient of capacity of the calibrated condenser is only 0.002 per cent per degree C., a thermometer is provided in the condenser housing to allow temperature corrections to be made.

Electronic Voltmeter

The use of the hydrogen ion concentration (pH) for analysis and control is becoming more and more practical, chiefly because the glass electrode and its attendant equipment has been developed to the point where it can be used by unskilled operators.

While the present glass electrodes are stable and rugged, their resistance is in the order of 300 megohms which places severe limitations upon the voltage measuring device. Thus it is desirable to keep the current drawn by the voltmeter down to 10^{-13} ampere or less so that it does not affect the voltage developed by the electrode.

In certain applications the voltage range required was about two volts with a smallest reading of 1 or 2 millivolts. Since this range cannot be obtained in a single scale it was decided to build a vacuum tube voltmeter with a range of 110 millivolts coupled with a potentiometer of 10

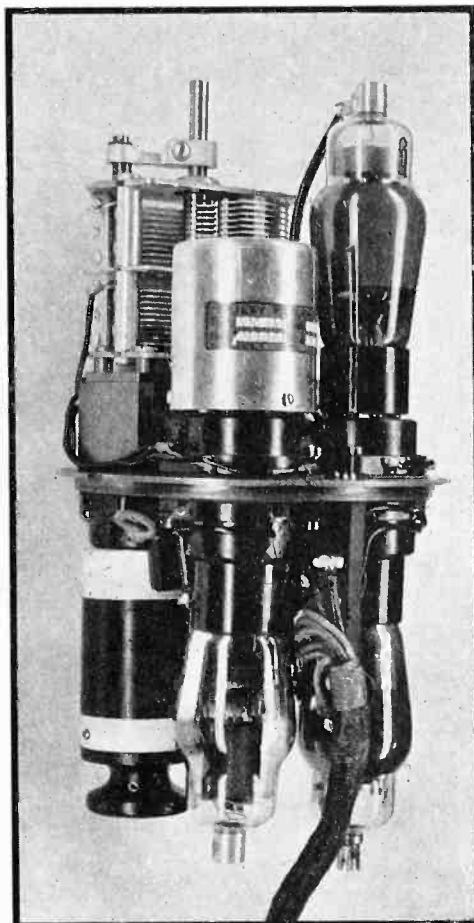

Fig. 5—Oscillator assembly which is contained within a copper cylinder whose temperature is controlled to within plus or minus 0.1 degree C.

steps of 100 millivolts each, and an additional step of 1 volt to give the complete range of 2.110 volts.

To keep the cost of tubes and filament-supply batteries at a minimum, standard battery-type receiving tubes were used in place of commercial electrometer tubes. Because it is best suited for electrometer work, the original screen grid tube (type 32) was selected for the first stage of the direct current amplifier. A more modern tube (type 1A5G) was chosen for the second stage.

The circuit is shown below in Fig. 6.

The following precautions were found necessary in this application. In order to maintain the input resistance of a tube at a maximum the glass envelope must be kept clean and dry and preferably coated with ceresin wax; low electrode voltages must be used to reduce the flow of positive ions to the grid; and the filament must be operated at reduced potential to minimize any tendency toward grid emission. Moreover, the tube should be shielded from light to prevent photoelectric emission.

The potentiometer is standardized by means of a standard cell which is incorporated in the unit, using the voltmeter circuit as the null indicator. A reversing switch is incorporated in the circuit so that the leads need not be changed when the potential is reversed in polarity. The meter, a 0-200 microampere d'Arsonval type, is provided with two millivolt scales linearly calibrated from 0 to 110 and 110 to 0 so that it is direct reading for both the direct and reverse connections.

The panel layout, Fig. 7, has been arranged for convenience of operation, employing two multipoint switches, one for filament switching and for direct and reverse electrode connections, and the other for zero, full scale, and potentiometer standardizing adjustments. Adjustable controls are provided for zero and full scale, and for potentiometer standardizing.

One of the difficulties with all d-c amplifiers is their tendency to drift. This is particularly true when the input resistance is maintained at such a high value. While drift has not been completely eliminated in

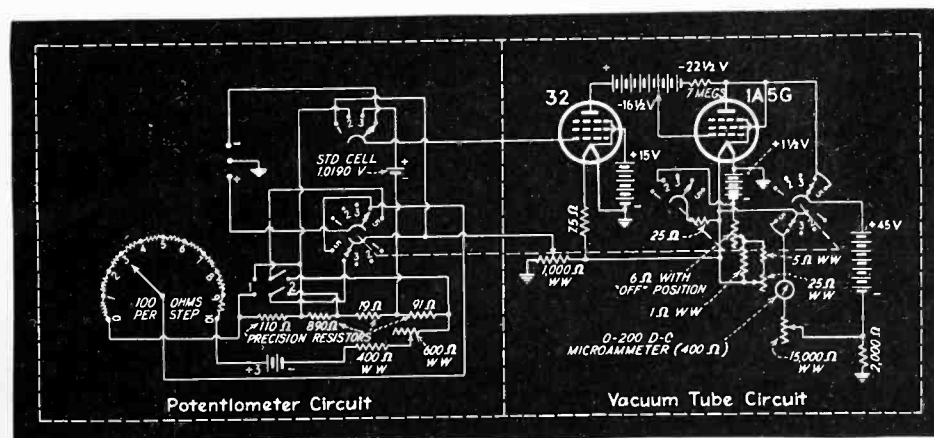

Fig. 6—Electronic voltmeter circuit which is used for the measurement of pH values. A voltage is developed across a glass electrode in contact with the liquid being measured. The voltage is then measured with this circuit

this instrument, it has been held to an equilibrium value of about 2 millivolts per hour which is not excessive and allows measurements of the desired accuracy with only an occasional resetting of the zero point. To eliminate the initial drift of from 10 to 15 millivolts per hour, the filaments remain on twenty-four hours of each working day. Under these conditions the life of the filament battery, four parallel-connected Burgess 4FJ Little Six cells, is four months.

Several months' application in an analytical laboratory has shown that this electronic voltmeter is suitable for use with any glass electrode and is suited for titrating either to a definite potential difference or to a maximum voltage change per increment, or for determining points for plotting potential-volume curves. The meter is equally applicable for the measurement of electromotive force developed between a reference electrode and silver, antimony, platinum, or tungsten, and because the current drain is of such small magnitude there is no tendency to polarization. It has all the advantages of both the potentiometer and continuous reading meter.

Electronic Relays

A recent application of the new miniature thyratron tubes is an oil oxidation test apparatus (Fig. 8) in which nineteen type 2051 tubes are used to run automatically eight simultaneous experiments. It proved possible with these inexpensive tubes to operate heavy duty lock-in relays with such low input contact currents that gassing at the contacts, which would have prevented the successful operation of the apparatus, is avoided.

In closing it should be emphasized that vacuum tubes are used only where they do the job better, easier or at less expense than by other methods. That this frequently is the case is an indication of their wide range of usefulness.

The authors wish to acknowledge the contributions of Messrs. F. B. Rolfson, H. W. Lindsay, and K. E. Hallikainen to the development of the instruments described in this paper.

¹ Schade, O. H., *ELECTRONICS*, 10, 26 (June, 1937).

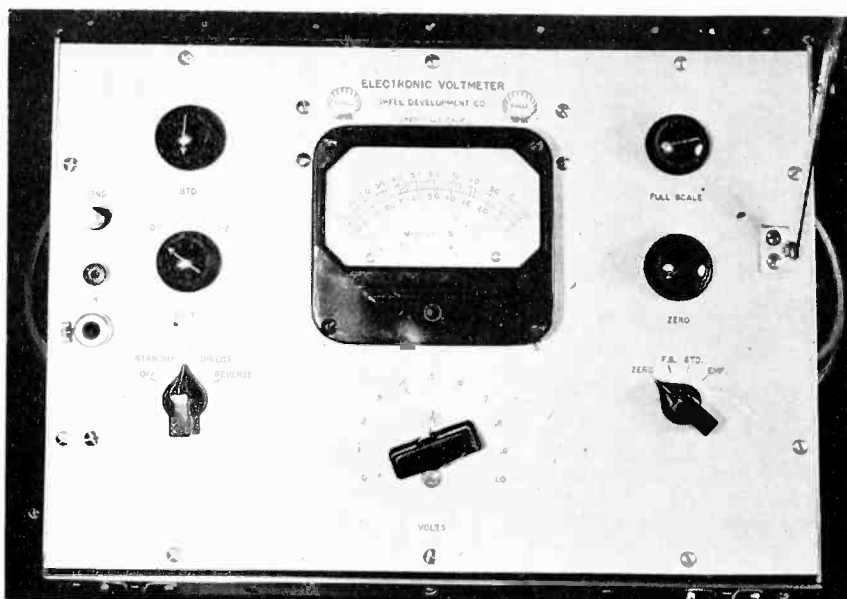
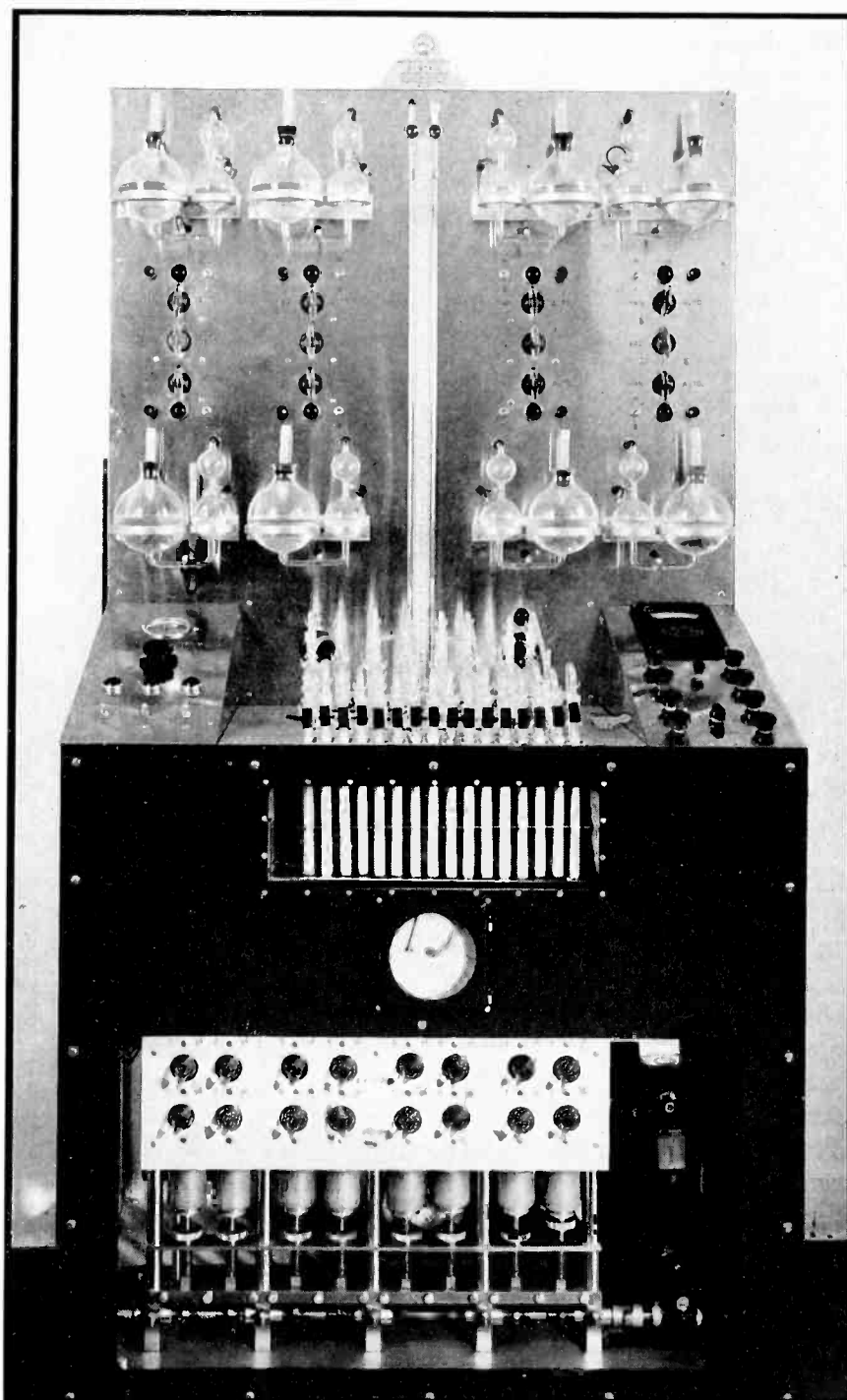

Fig. 7 (above)—Panel of the electronic voltmeter. The current drain of this instrument is of the order of 10^{-13} ampere which makes it suitable for a variety of purposes. Fig. 8 (below)—Nineteen type 2051 tubes operating heavy duty lock-in relays are used in this apparatus which performs eight simultaneous oil oxidation tests



A Ruler for Record Patterns

In checking the response of a recording system, it is convenient to have a measuring rule which will convert the width of the "Christmas-tree" diffraction pattern directly into decibels above or below a known reference. The response curve can thus be plotted quickly

IN testing instantaneous recording equipment for overall frequency response it has become quite a common practice to use the diffraction pattern method. In this method a record is cut, using an oscillator or other source of constant voltage input, and cutting a series of different frequencies at a constant input level. If the record so cut is held so that parallel beams of light strike the surface at a considerable angle, the reflected light forms a pattern, the width of which is directly proportional to the velocity of the stylus at that point. The width of the pattern is also a measure of the absolute value of the velocity and thus the cutting level.

It is customary in analyzing this pattern to measure the width with a caliper or ruler at the different points of interest and to convert the resulting ratios into decibels or volume units in order to interpret the results properly. This procedure is much simplified by the use of a simple scale which is illustrated here, on which the pattern width reads directly in decibels. By this means the frequency characteristic may be interpreted at a glance, and in addition the actual level of the cut is known.

The scale is constructed by the use of the equation:

$$V = \frac{W \pi N}{60}$$

Where V = Velocity of the stylus in centimeters per second

By DON R. KING

N = Number of revolutions of turntable per minute

W = Width of pattern in centimeters

The zero point of the decibel scale has been set at the point corresponding to a stylus velocity of 6.35 centimeters per second (2.5 inches per second). This figure is the generally accepted standard recording level and the scale then indicates the variation referred to this standard.

The scale may be glued to a heavy piece of paper or if a more substantial one is wanted the graduations may be scratched on a strip of celluloid. It is possible to obtain inexpensive celluloid rules which have printed metric divisions and

the values given in the accompanying table may be scratched on the ruler, using the printed markings on the rule itself for measurements. The original markings may then be removed with emery cloth and the scratches filled with white wax crayon.

While the diffraction pattern method of measurement is more suited to constant velocity records, the scale may also be applied to constant amplitude records. In this case it must be remembered that the velocity is directly proportional to frequency and the pattern width instead of being constant, should increase 6 decibels per octave. In using the scale, the 1000 cycle per second band should measure 0 decibels and each octave above or below should differ by 6 decibels.

VALUES USED IN RULER SCALES

Db/Vu	Velocity cm/sec	Pattern Width, cm		Db/Vu	Velocity cm/sec	Pattern Width, cm	
		78 rpm	33-1/3 rpm			78 rpm	33-1/3 rpm
-18	0.79	0.20	0.46	+ 5	11.3	2.76	6.46
-12	1.59	0.39	0.91	+ 6	12.7	3.11	7.28
-10	2.00	0.49	1.15	+ 7	14.2	3.48	8.14
- 8	2.54	0.62	1.45	+ 8	15.9	3.91	9.14
- 6	3.18	0.78	1.82	+ 9	17.9	4.39	10.3
- 5	3.57	0.88	2.05	+10	20.3	4.90	11.5
- 4	4.00	0.98	2.30	+11	22.6	5.53	12.3
- 3	4.50	1.10	2.58	+12	25.4	6.22	14.5
- 2	5.08	1.24	2.89	+13	28.4	6.95	16.3
- 1	5.65	1.39	3.24	+14	31.8	7.79	18.2
0	6.35	1.55	3.64	+15	35.7	8.75	20.5
+ 1	7.12	1.75	4.08	+16	40.6	9.82	23.0
+ 2	8.00	1.96	4.58	+17	45.0	11.0	25.8
+ 3	8.97	2.20	5.15	+18	50.8	12.4	28.9
+ 4	10.16	2.48	5.78	+19	56.5	13.9	32.4
				+20	63.50	15.5	36.4

Referred to standard recording level of 6.35 cm/sec (2.5 in/sec)

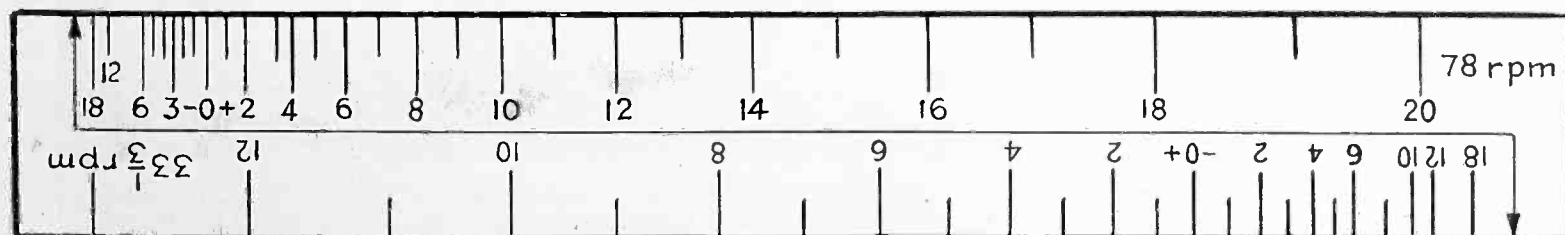

The arrow at the end of the scale is placed at one edge of the diffraction pattern. The other edge then falls opposite the recording level present in that portion of the pattern

TUBES AT WORK

A rotary beam antenna for mobile broadcasting, an electronic switch, a simple identification instrument for broadcast stations, a practical audio bridge circuit, and hum neutralization in loudspeakers are discussed this month

A Rotary Beam for Mobile U-h-f Relay Work

BY GENE RIDER
Chief Engineer, WQAM

ULTRAHIGH FREQUENCIES in the 30- to 40-megacycle band are widely used for relaying programs to broadcast stations from points where telephone loop installations are impossible. Since most of the transmitters are low powered, the technical crews of many broadcast stations have encountered a problem in getting consistent coverage from "downtown" areas. The engineering department at WQAM was confronted with such a problem.

A part of WQAM's field equipment is a 15-watt mobile broadcast transmitter, working on 31.22 megacycles, installed in a sedan delivery truck. The vertical whip antenna was mounted in the center of the truck's conventional turret top. Since there are many low hanging palm trees, trolley wires, traffic lights and underpasses in Miami, it was necessary to prune the vertical antenna to a six foot length, and to load it for quarter wavelength operation.

The receiver was installed atop a fifteen-story office building downtown where the studios are located. Downtown locations for such receivers are notoriously poor due to high noise levels from elevator motors, trolley cars, and ignition and hence should be avoided wherever possible. But seldom is there an alternative. The receiving antenna in this case might have been mounted atop WQAM's 230-foot vertical radiator at the station's transmitter, clear of the downtown noise fields, but the gain would have been nullified because the tower is three miles from the downtown area where most of our mobile shows originate. Hence for height and convenience, a downtown office building was mandatory as a receiver location.

The fifteen watts of power in downtown areas amid many high building shadows, with the receiver located in the heart of the city's noise field, tended to limit the area that could be covered roughly to a four-mile radius, for high quality noise free transmission. But despite repeated warnings from the engineering department, the observer and announcer constantly wandered beyond the radius we could safely serve. The situation called for

some experimentation leading to the use of a rotary beam for mobile use.

The use of parasitic reflectors and directors is quite common but since our truck top is only about seven feet wide, the usual quarter-wave spacing of the reflector was not possible. After experimentation it was found that a parasitic reflector spaced one-eighth wavelength from the vertical radiator and a parasitic director spaced one-tenth wavelength from the radiator produced about five decibels gain in the forward direction and a front-to-back ratio of approximately three to one.

The mechanical arrangement for rotating the array from within the truck while underway is as follows: The transmitter was installed a few inches from the inside of the truck top, so placed that the hole for the feed-through insulator could be drilled in the center of the turret top. A two inch hole was then cut in the top and a six-inch length of two-inch pipe was mounted over the hole and attached to

the metal top by means of a threaded flange. The pipe serves as a base for the crosspiece that carried the parasitic elements.

A seven-foot length of one-by-two inch wood, covered with sheet copper, was employed as a mounting for the rotating parasitic elements. A hole was cut in the middle of this member and a one-foot length of one and three-quarter-inch pipe was fitted to the hole by means of a threaded flange.

The array is quickly and easily mounted. The vertical radiator is detached from its base atop the transmitter, the pipe on the cross piece carrying the parasitics is set in the six-inch length of larger pipe. The vertical radiator is then fed down from the top through the pipe mounting of the cross piece and attached to its base on the transmitter. A loose fitting feed-through insulator is necessary on the inside of the pipe to stand off the radiator.

The one-foot length of pipe attached to the cross piece extends several inches through the truck top, leaving room to fasten a small detachable handle for the operator to use in rotating the array. The weight of the cross piece is enough to keep a firm ground connection between the two pipe mountings, thus dispensing with slip rings, since the mounting pipe bolted to the top is at ground potential.

Ordinary telescopic auto receiving antennas were used as parasitic elements with small mounting flanges at their bases for bolting to the cross piece. Telescopic antennas are recommended to facilitate rapid tests at various cut and try lengths. After

PUBLIC ADDRESS SYSTEM FOR SPOTTER



This British railroad lookout man on the roof of King's Cross Railway terminal has one of the best vantage points from which to spot Nazi raiders. As indicated by the microphone and control panel, he is equipped with a public address system by which he may issue warnings in the event of approaching enemy aircraft



IT TAKES ALL KINDS OF LUGS . . .

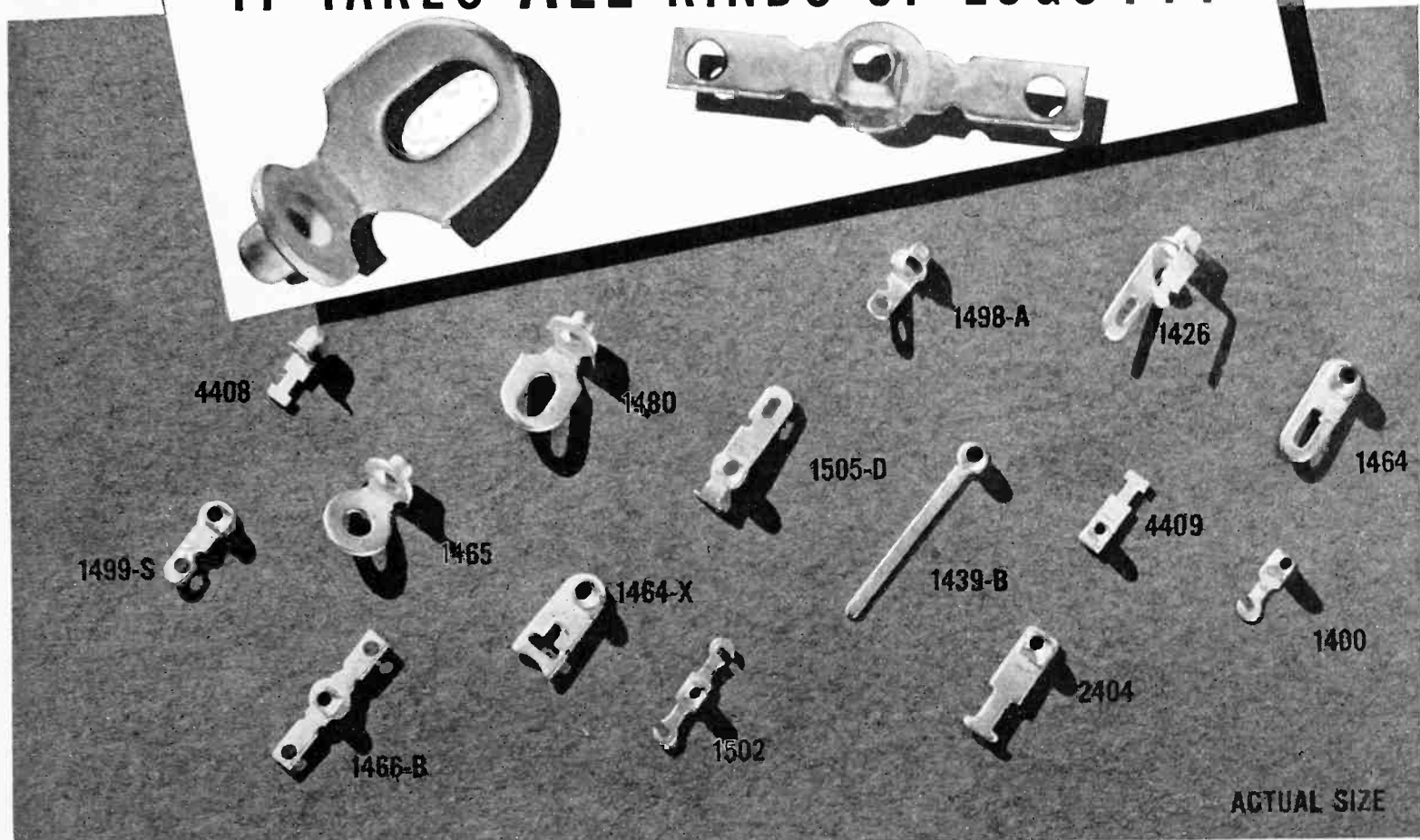

TO GIVE YOU THE KIND YOU NEED!

Here are hundreds of sizes and types . . . originally designed for a specific purpose—already tooled—all now serve in a wide variety of uses.

● "CINCH" lugs contribute a big service to radio set manufacturers. Modern production methods, and increased facilities have extended the variety, and the service of these small parts. Of the best material and workmanship with "CINCH" special solder coating!

Cinch and Oak Radio Sockets are licensed under H. H. Eby socket patents.



MANUFACTURING CORPORATION

2335 West Van Buren Street, Chicago, Illinois

SUBSIDIARY: UNITED-CARR FASTENER CORP. • CAMBRIDGE, MASS.

HIGH SPEED—LOW COST MEASUREMENTS



No. 205 AG Audio Signal Generator. Combines a Resistance tuned oscillator having 5 watts output and less than 1% distortion, plus Output meter, Input meter, Attenuator and an impedance matching system... all in a single unit. Price \$340 Net.

IMPORTANT NEW DEVELOPMENTS IN TEST EQUIPMENT SAVES YOU TIME AND MONEY



resistance tuned audio oscillators set a new standard of performance in laboratory and field testing. The saving of time, extreme accuracy and versatility of measurements coupled with low cost makes them the most profitable investment in the electronics field.

hp— instruments are the result of long research in a well equipped laboratory and have been thoroughly tested both in the laboratory and the field. You'll profit in many ways by investigating, at once, the advantages of these new instruments. Write today for data sheets. There's no obligation of course.

Laboratory
INSTRUMENTS
for speed and accuracy

HEWLETT-PACKARD CO.
481 Page Mill Rd., Palo Alto, Calif.

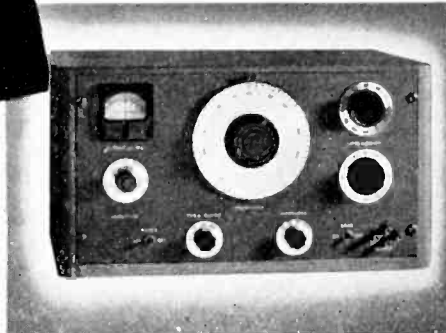

No. 205A Audio Signal Generator. Identical in every respect to the 205AG with the exception of the input gain set which is not included. Price \$290 Net.

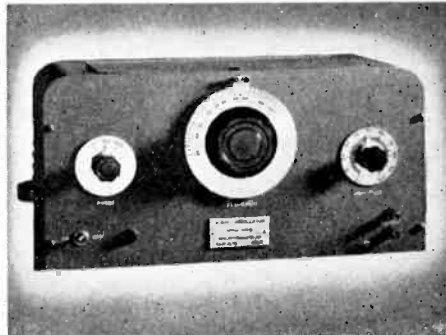

Series 200 Resistance Tuned Oscillators. Consists of hp Resistance Tuned Oscillator only. Available in cabinet or for relay rack mounting in models A, B, C & D, covering frequency range from 7 cps. to 200 kc. Priced \$85.50 to \$130 Net.

Resistance Tuned Principle

A stabilized amplifier with regeneration supplied through a frequency selective resistance capacity network. The oscillation frequency is stable and the thermal drift extremely low. Furthermore, the thermal drift is not magnified as is the case with the beat frequency oscillator. A balancing circuit automatically selects the proper operating point for the oscillator. The result—a stable oscillator having constant output and very low distortion. Whether for low frequencies, geophysical work or high frequencies in the super-sonic region—resistance tuning is vastly superior. Send us your problems requiring audio frequency or super-sonic oscillators.

Write today... No obligation

optimum lengths are found, they may be welded permanently at that length. "C" clamps are also recommended for holding the parasitic element bases to the cross piece during experimenting. When the best spacing is found, they may then be bolted firmly. A simple field strength meter, a diode rectifier arrangement using a type 30 tube, is valuable for testing.

In conventional parasitic reflectors and directors used with a half wave radiator, the reflecting element is usually five per cent longer physically than the radiator and the director slightly shorter than the radiator. But when dealing with a short radiator loaded to a quarter wavelength, none of these rules holds. In the case described the optimum length of the



Rotary beam antenna mounted on top of the mobile unit

director was found to be four inches longer than the radiator and the reflector six inches longer.

During mobile broadcasts, the operator wears headphones connected to the automobile receiver and tuned to WQAM's 560-kc signal, and thus is able to determine whether the u-h-f receiver is in the mobile transmitter's beam. The directivity beam of this array is not too sharp, approximately thirty degrees wide, and it is a simple matter for the operator to keep the array trained on the receiving location at all times, no matter how many turns the driver may make.

On short hauls when the rotary beam is unnecessary, it is quickly removed and since the parasitic elements affect the final stage's tuning only slightly, the transmitter is quickly retuned by adjusting the tank condenser.

The five decibel gain added about a mile and a half to the radius of noise-free reception.

• • •

A Four Circuit Electronic Switch

BY ESTEN MOEN

A SYSTEM FOR OBSERVING four independent electrical phenomena on a cathode-ray tube screen is illustrated in Fig. 1. The division of a simple linear scan into four components, each following in succession, is made possible by utilizing the system of tubes and circuits shown in Fig. 2. If, as shown in Fig. 1C, a pure sine-voltage wave is impressed on the grid of a triode, and the grid bias is held at a sufficiently high negative potential, the



Sylvania "Lock-In" Tube Stays Where You Put It IN ANY APPLICATION



NEVER BEFORE has it been so vital that radio tubes be able to "stand the gaff". They must "stay put" no matter what the vibration or concussion, for even the slightest radio failure may be costly in human life.

The Sylvania "Lock-In" Tube is the answer to this requirement. Sturdily made in every detail, this tube locks in its socket and comes out only when you want it to. Therefore, the Sylvania "Lock-In" Tube is the ideal

tube for armored tanks, armored cars, bombing, fighting and transport planes, motor cars, for battleships, cruisers, destroyers and submarine chasers, as well as for portable and home sets.

Select the tube that stays in place through wracking jars or shuddering vibration whether it's mounted upside down or sideways. You are sure of satisfaction with the Sylvania "Lock-In" Tube.

Sylvania Radio Tube Division

HYGRADE SYLVANIA CORPORATION

300 FIFTH AVE., NEW YORK • EMPORIUM, PA., SALEM, MASS., ST. MARYS, PA., IPSWICH, MASS.

Also makers of Hygrade Lamp Bulbs, Hygrade Fluorescent Lamps and Miralume Fluorescent Light Fixtures

New DECADE AMPLIFIER

MODEL 220

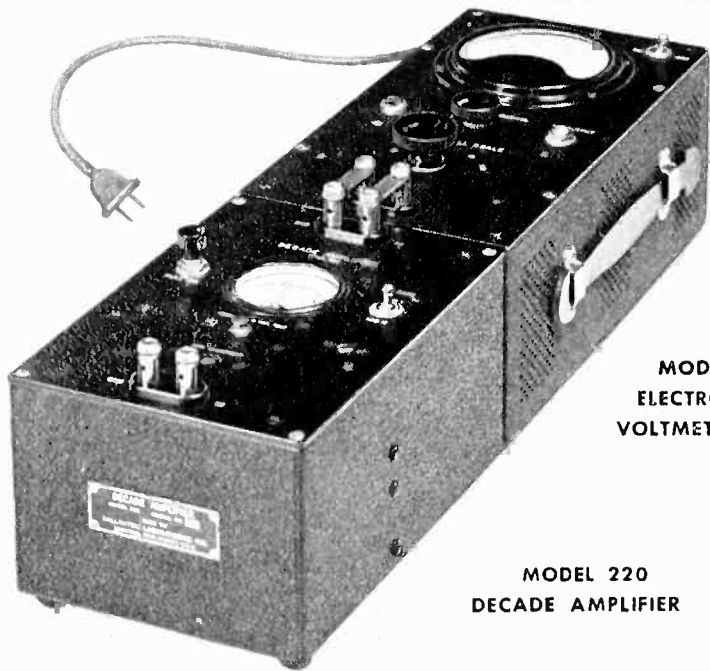

MODEL 300
ELECTRONIC
VOLTMETER

MODEL 220
DECADE AMPLIFIER

NEW ACCESSORY FOR MODEL 300 VOLTMETER FOR MEASUREMENT OF VERY LOW A-C VOLTAGES

Decade Amplifier: This is a highly stable amplifier giving accurately standardized gains of 10x or 100x over a frequency range of 10 to 100,000 cycles. Operated by self-contained batteries having a life of over 150 hours. Used with our Model 300 Electronic Voltmeter (as shown in cut) A-C voltages down to 0.00003 volt (30 microvolts) can be measured. By means of special circuits the gain is independent within 2% of circuit constants, battery voltages and tubes. Fully described in Bulletin 7.

Electronic Voltmeter: A popular instrument for the measurement of A-C voltages, 10 to 150,000 cycles, 1 millivolt to 100 volts (up to 1000 and 10,000 volts with Model 402 Multipliers). Logarithmic voltage scale and auxiliary uniform decibel scale. A-C operated. By means of special circuits indications are independent of line-voltage, tubes and circuit constants within 3% over entire frequency range. Several accessories, such as an artificial ear, vibration pickup and multipliers are available. Fully described in Bulletin 6.

MADE BY

Ballantine Laboratories, Inc.

BOONTON, NEW JERSEY

ELECTRICAL AND ACOUSTICAL INSTRUMENTS

tube will pass to the plate only the upper crest of the positive peak of the wave, represented by shaded area *K*, which will give a horizontal component on the axis of one-fourth cycle. The negative grid bias voltage necessary to accomplish this much is 0.707 of the peak impressed voltage. The above process utilizes one tube to pass one-fourth of the cycle. A second tube passes the negative peak labelled *M* in Fig. 1C. The remaining two quarters of the cycle represented by the areas *L* and *N* are selected by displacing the wave 90 degrees in phase and repeating the process. As a final result, the trace on the screen of the oscilloscope will consist of four "scallops" shown in Fig. 1D.

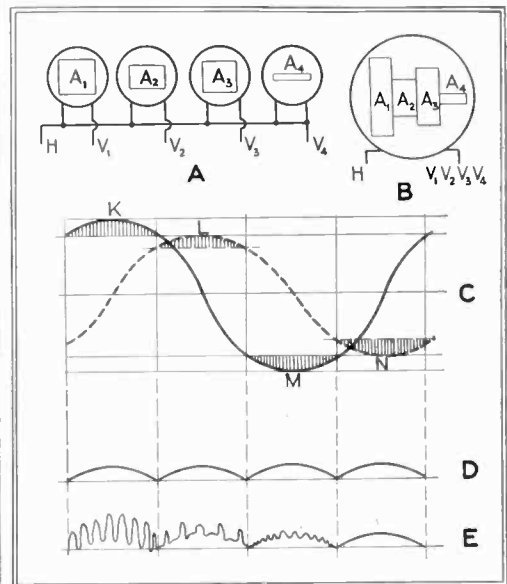

Fig. 1. Analysis of operation of the electronic switch

The circuit which accomplishes these operations is given in Fig. 2. Tube *T*₁ is simply a controller of amplitude. It receives the input wave from a sine-generator whose frequency is identical with that of the horizontal sweep of the oscilloscope. The frequency for which the circuit values apply is 2,000 cps, but the scan can vary from 1,000 to 3,000 cps.

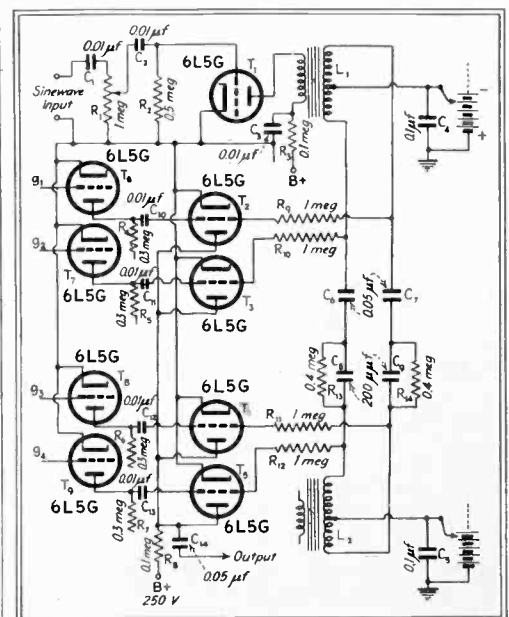
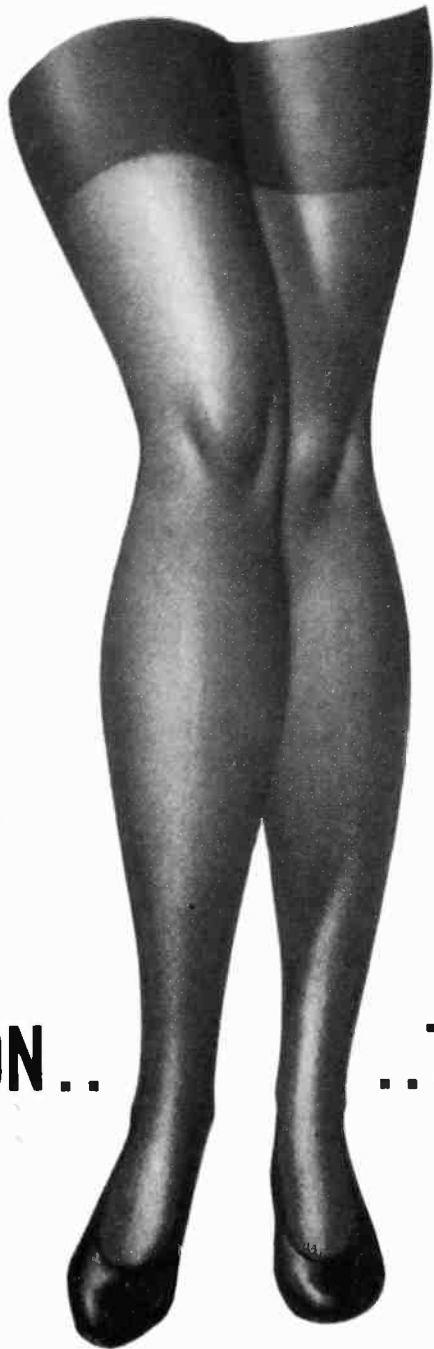

Fig. 2. Circuit diagram of the electronic switch



THERE'S MORE TO NYLON... ..THAN MEETS THE EYE!

*The inside story of another
Anaconda development ...*

Now! Anaconda magnet

By exhaustive laboratory and service tests, these magnet wire were proved...let them go

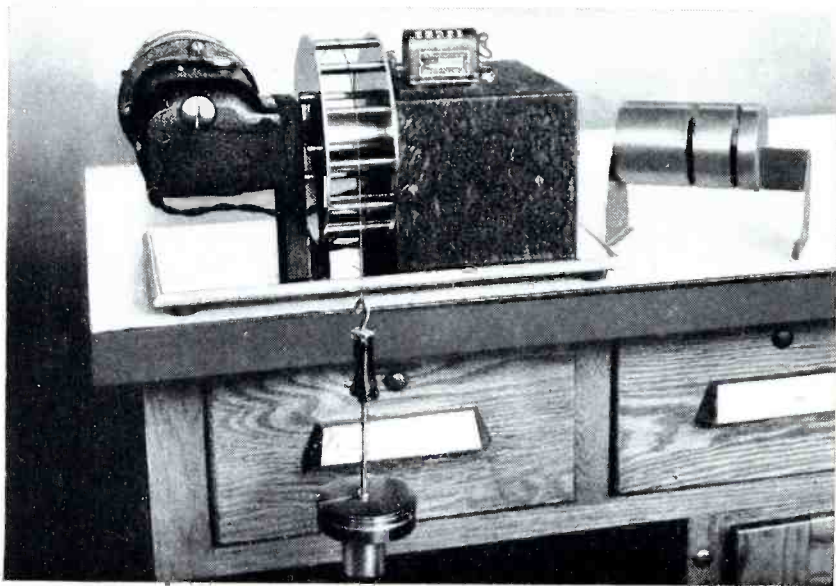

Exceptional Resistance to Abrasion: The machine above, used for testing the abrasion resistance of Anaconda Nylon Enameled Magnet Wire, is designed to simulate conditions to which the wire is subjected during the winding operation. The resistance to abrasion was measured by the number of rubs of the abrading surfaces required to wear off the insulation and come in contact with the conductor of the wire under test. The average abrasion resistance of several hundred tests was over 300,000 rubs—that's plenty tough!

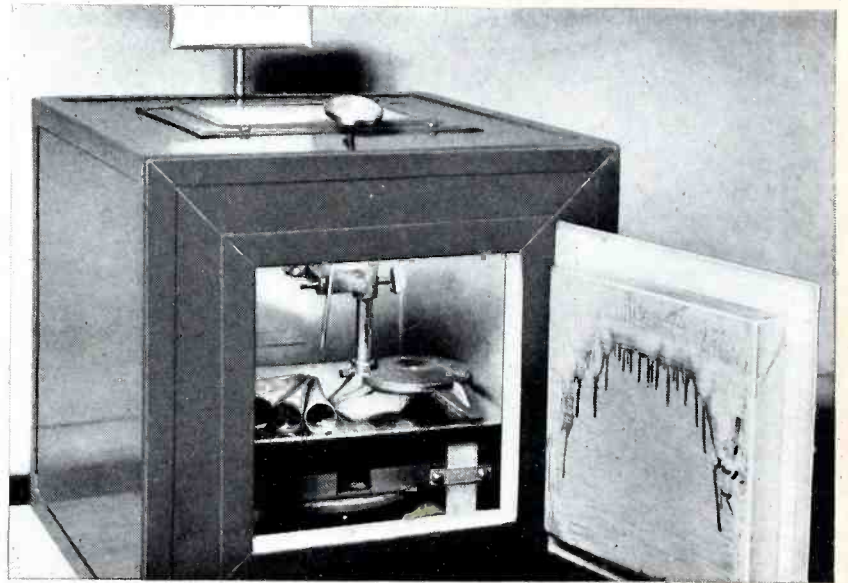

No Failure in Rigid Heat-Aging Tests: This test was made in order to determine how the film of insulation would react to actual conditions experienced in a winding. Small conical-shaped coils, starting with the diameter of the wire at the apex and gradually increasing to fifteen times the diameter of the wire, were placed in an oven at 125° C. and examined periodically for cracks in the film. Subjected to this test for over 4,000 hours, Anaconda Nylon Enameled Magnet Wire came through without a sign of failure.

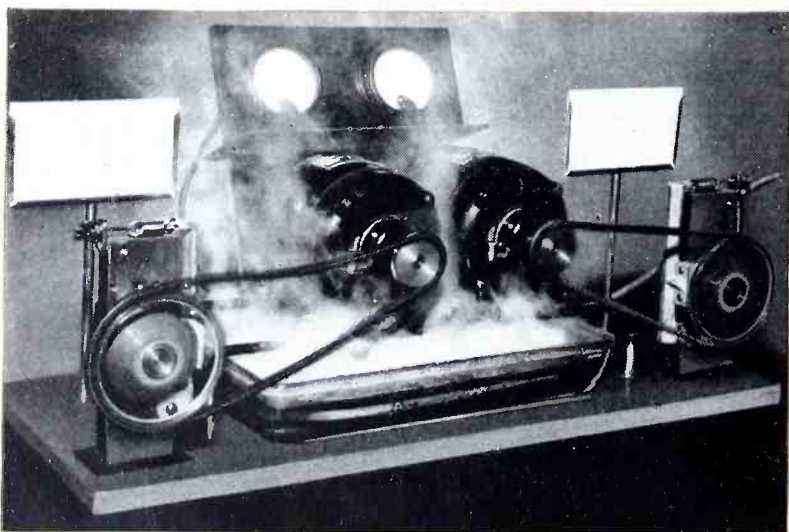

In a Steam Bath—Infinite Resistance: These two motors wound with Anaconda Nylon Enameled Magnet Wire are 110-Volt, 60 cycle, single-phase, $\frac{1}{16}$ HP and are operating at full load. The windings in one are varnish impregnated, the other unimpregnated. Operating for 3,512 hours as of March 15, 1941, they have been subjected to a bath of steam for 9 out of every 24 hours. Each morning the insulation resistance is measured with a 500-Volt hand-driven Megger. Both motors have consistently shown Infinite Megger readings.

Good Dielectric Strength: On testing the dielectric strength of Anaconda Nylon Enameled Magnet Wire according to NEMA standards, voltage has been applied to both layered and twisted specimens under conditions permitting high accuracy in measurements. Its insulation film registered good dielectric strength consistently.

wire insulated with **NYLON**

for

**advantages of NYLON
to work for you!**

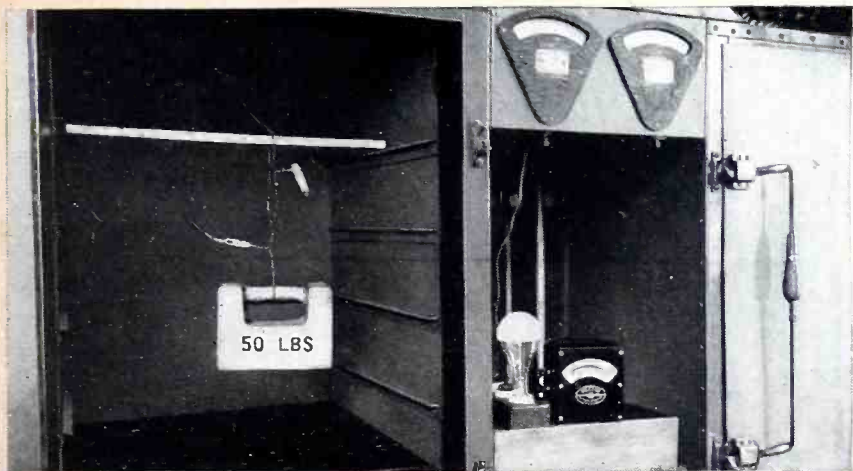

Excellent Performance Under Temperature and Compression: In testing for performance under conditions of compression and temperature, two specimens of magnet wire 10 inches long are formed into a two-link chain, which is suspended in an oven at a temperature of 150° C. The upper link of the chain is anchored in the oven top, and a weight of 50 lbs. fastened to the lower link. A potential of 110 Volts AC is applied between the point of contact of the two links. Lighting of a lamp in a series with the 110-Volt circuit indicates failure.

Anaconda Nylon Enameled Magnet Wire withstood this test for 288 hours. At the end of this time, the wire, having been subjected to this severe strain, broke in two. The film of insulation gave no indication of electrical or mechanical breakdown.

★ ★ ★ ————— ★ ★ ★
★ ★ ★

**Service Records Show Anaconda Nylon Wound
Motors Have Infinite Megger Readings:**

Graphic plots of periodic Megger tests are a good barometer of what's taking place in an insulation. And on that point, take a look at what the record shows for Nylon wound motors in a large Michigan plant:

Megger tests have been recorded of the insulation resistance of some three dozen of these motors in the plant. The readings were taken through periods ranging from three to twelve months. Some of these motors are subjected to extremely strenuous conditions and the majority of them are located in hot, damp places. However, each and every one has registered Infinite Megger readings time after time without variation.

★ ★ ★

- Industrial fan motors
- Automotive generators
- Wind-electric generators
- Gasoline-electric generators
- Vacuum cleaners
- Pump motors
- Fan motors
- Lifting magnets
- Magnetic separators
- Food mixers
- Electric drill motors
- Heater motors
- Fractional horse-power motors
- Communication transformers
- Neon sign transformers
- Voltage regulators
- Ignition coils
- Refrigerator motors

In conclusion...

The importance of single-control production from mine to finished product... another ANACONDA advantage

PERHAPS you have noticed the Anaconda trademark. If so, you've probably also seen the legend it bears: "Anaconda—from mine to consumer." Well, for you those few words have a world of importance. Translated into concrete consumer advantages, they mean that you're getting a product that's had the benefit of coordinated metallurgical supervision by a single organization at every step "from ore to finished product."

After the ore is mined, control begins at the smelter and continues through the refinery, the

casting of wire bars, hot rolling and cleaning of rods and wire drawing. And then through the annealing and tinning operations. But that isn't all.

Further research and development of products are continually being carried out in the laboratory. Every possible step is taken to bear out the responsibility and further the fine reputation behind the Anaconda trademark. The result: The customer benefits by obtaining the best electrical wire that it is possible to produce. You can prove this to your own satisfaction.

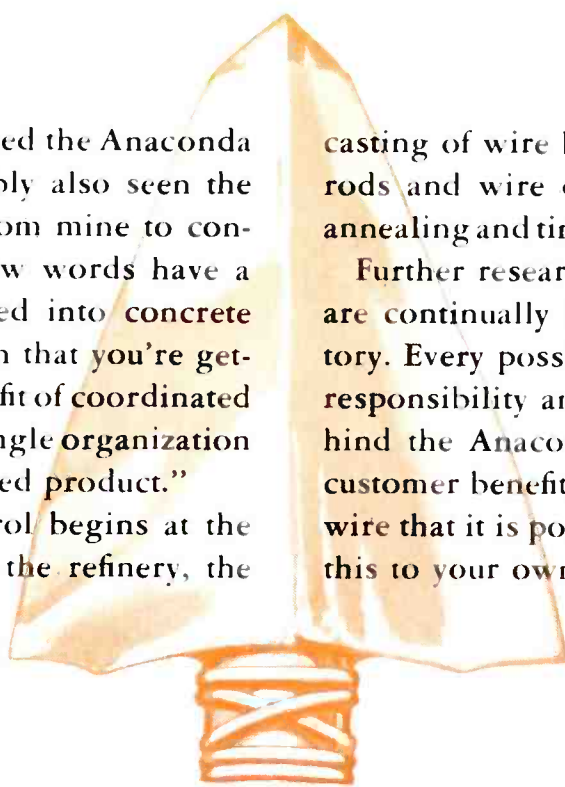

USE MODERN, IMPROVED

Anaconda Wire & Cable

ANACONDA WIRE & CABLE COMPANY

General Sales Offices: 25 BROADWAY, NEW YORK Chicago Sales Office: 20 NORTH WACKER DRIVE

DISTRICT SALES OFFICES AT

ATLANTA, GA.	66 Luckie Street	MILWAUKEE, WIS.	Bankers Bldg.
BOSTON, MASS.	49 Federal Street	MINNEAPOLIS, MINN.	Rand Tower Bldg.
CINCINNATI, OHIO	Chamber of Commerce Bldg.	NEW ORLEANS, LA.	Carondelet Bldg.
CLEVELAND, OHIO	1825 Republic Bldg.	PHILADELPHIA, PA.	Architects Bldg.
DALLAS, TEXAS	Interurban Bldg.	PITTSBURGH, PA.	Oliver Bldg.
DENVER, COLO.	Continental Oil Bldg.	ROCHESTER, N. Y.	89 East Avenue
DES MOINES, IOWA	Des Moines Bldg.	ST. LOUIS, MO.	Continental Bldg.
DETROIT, MICH.	New Center Bldg.	SAN FRANCISCO, CAL.	111 Sutter Bldg.
KANSAS CITY, MO.	106 West 14th Street	SEATTLE, WASH.	1420 Exchange Bldg.
LOS ANGELES, CAL.	704 Architects Bldg.	WASHINGTON, D. C.	Investment Bldg.

MANUFACTURING PLANTS AT

ANDERSON, IND. . ANSONIA, CONN. . GREAT FALLS, MONT. . HASTINGS-ON-HUDSON, N.Y. . KENOSHA, WIS.
MARION, IND. . MUSKEGON, MICH. . OAKLAND, CAL. . ORANGE, CAL. . PAWTUCKET, R. I. . SYCAMORE, ILL.

The phase-shift circuit is connected between transformer secondaries L_1 and L_2 , which are matched audio input units whose center taps connect to the condensers C_4 and C_5 . The primary winding of L_2 is not used. Condensers C_6 and C_7 act to block the grid bias voltages. Condensers C_8 and C_9 together with resistors R_{13} and R_{14} shift the phase of the wave in L_2 90 degrees from the wave in L_1 . The extremities of the inductances L_1 and L_2 are accordingly points of 180 degrees phase difference. They are connected through individual resistors R_9 , R_{10} , R_{11} , and R_{12} to the grids of tubes T_2 , T_3 , T_4 , and T_5 . Referring to the wave in Fig. 1C resistor R_9 relates to area K, resistor R_{10} to area M, R_{11} to area L, and R_{12} to area N. The plates of the tubes T_2 , T_3 , T_4 , T_5 are fed 250 volts across R_8 . The output signals are passed through C_{14} to the oscilloscope vertical input.

The wave-crests act as switches for admitting four independent sources of signal. The tubes T_2 , T_3 , T_4 , and T_5 , operate in succession each for one fourth of the cycle. Four additional tubes T_6 , T_7 , T_8 , and T_9 act as buffer amplifiers. The pick-up points are the grids g_1 , g_2 , g_3 and g_4 . Means for either amplifying or of attenuating the input at each of these points should be provided so that the area projected on the screen of the oscilloscope can be regulated.

It is important that the common plate circuit of tubes T_2 , T_3 , T_4 and T_5 , be adequately shielded against any stray potentials. The success of this circuit depends on the care with which stray coupling capacities are kept to the minimum.

• • •
BROOKLYN SCHOOL OPEN ALL NIGHT FOR DEFENSE

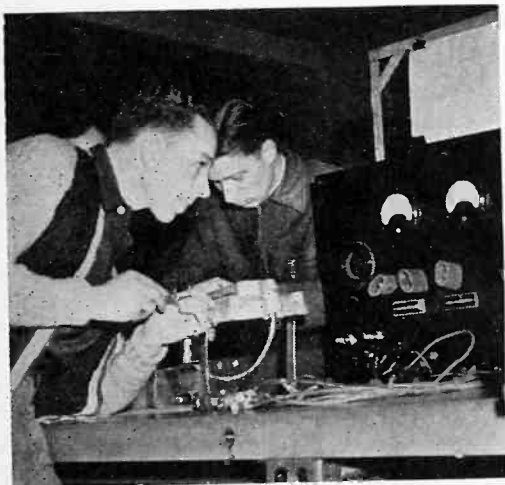

The Brooklyn High Schools are now running a 24-hour schedule in instructing students in the trades, as part of its adult trade courses operating under the Board of Education's emergency training program for national defense. Here are shown students in the electrical class, obtaining a better understanding of electrical, radio, and electronic fundamentals in the early hours of the morning

WIDER COVERAGE

... added to appearance and strength

Because of its better coverage, a Blaw-Knox Vertical Radiator brings more listeners to a station . . . steps up its following, its profits. The attractive appearance — so valuable to a station — is the natural result of correct designing. The strength of a Blaw-Knox Radiator shows up, not only under great stresses, but also in low maintenance cost. It all sums up in this: Blaw-Knox KNOWS HOW to make this equipment . . . knows it from the engineering, electrical, designing and structural angles. This knowledge is at your service at any time. Write or wire.

Blaw-Knox Division of Blaw-Knox Company
 Farmers Bank Building, Pittsburgh, Pa.

BLAW-KNOX VERTICAL RADIATORS



DISTRIBUTOR
Graybar
 ELECTRIC COMPANY

BLASTED BY BOMBS

X-RAY TUBE
LIVES ON!

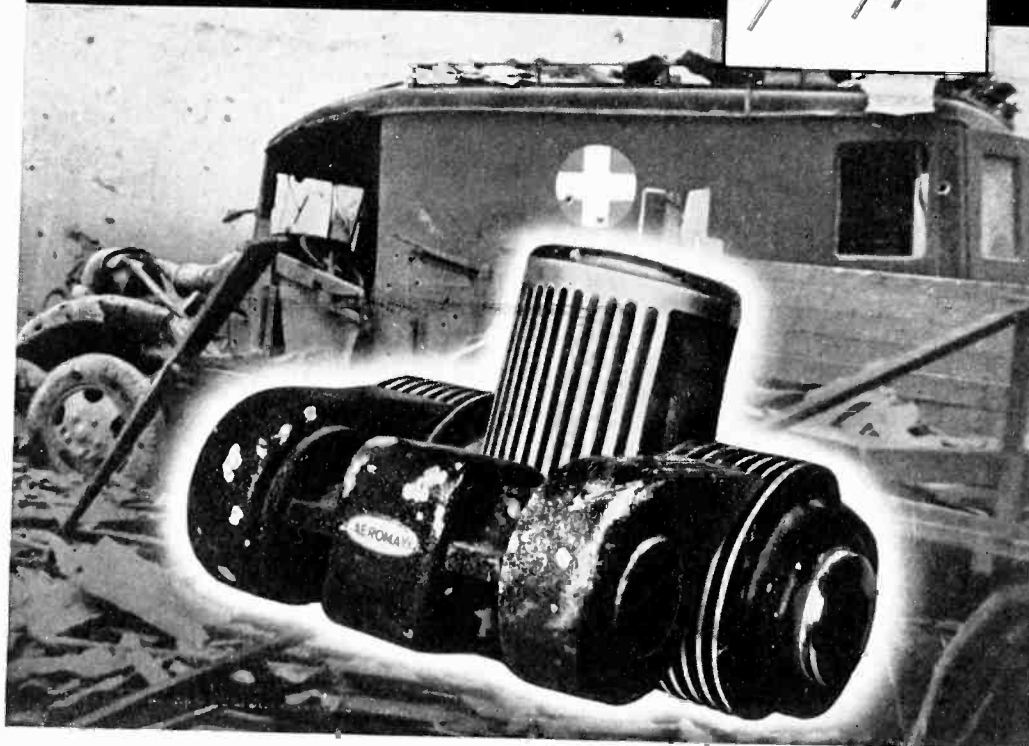

a **MACHLETT** development
to which **CALLITE** contributed

"SOMEWHERE IN ENGLAND" enemy bombs destroyed a mobile X-ray unit. (Hats off to you, England—in this your finest hour!) Amid the wreckage, searchers found this Machlett X-ray tube intact. Shrapnel pitted and scarred, the tube was still in perfect operating condition!

Contributing to this amazing stamina was the skill of Callite research engineers. For many a Callite part is used in every Machlett tube. Indeed, Machlett confidently looks to Callite for the same dependability which distinguishes its X-ray tubes — under the most trying circumstances.

Your product may never be called upon to endure an air-raid. But for that extra measure of stamina it takes to stand up under extraordinary conditions, you do want the dependability Callite parts assure. Callite is your logical source for many essential raw materials. There is a large group of Callite Tungsten products, each designed to do a particular job better. Why not consult us today. Send for catalog.

Manufacturers of electrical contacts of refractory and precious metals, bi-metals, lead-in wires, filaments and grids — formed parts and raw materials for all electronic applications.

CALLITE TUNGSTEN
CORPORATION

544-39th STREET

CABLE:

BRANCHES: CHICAGO • CLEVELAND



UNION CITY, N. J.

"CALLITES"

A Simple Station Identification Device

BY NORMAN H. BLAKE
Chief Engineer, WBRK

AT MANY STATIONS, particularly small stations carrying network programs, it has become customary for station identification announcements to be taken by the operator at the transmitter, whenever there is no studio announcer on duty. Some of the larger stations use an expensive machine especially constructed for this purpose and makes use of a sound-track tape in conjunction with a photoelectric circuit, but the cost makes it prohibitive for the small station. Transcribed station announcements often become objectionably noisy in a short time. This has been found to be true not only of instantaneous recordings but of pressings as well due partly to necessary excessive handling and "cueing in". Dust also contributes its share to this condition.

A simple, inexpensively-constructed device for taking station identification announcements automatically may be readily assembled by the station engineer. Briefly, it consists of a 33-rpm turntable with pick-up arm, a triple-pole single-throw switch and a twelve-inch transcription containing station identification announcements.

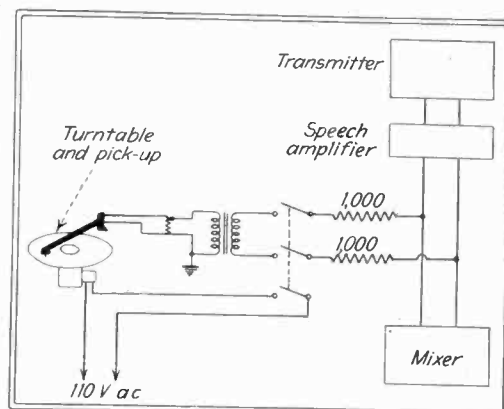
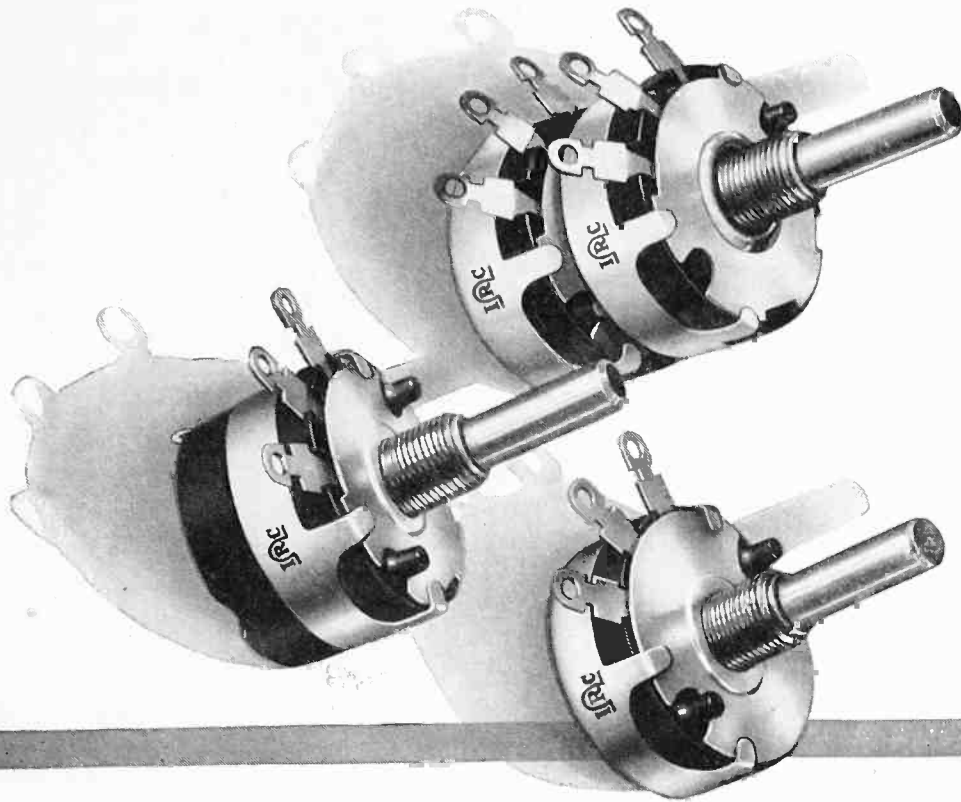

Diagram showing connection of announcing turntable to transmitter

The 33-rpm turntable used here is a small unit costing originally about ten dollars. It serves the purpose in this case as well as an expensive one since it runs for only a few seconds intermittently. An ordinary crystal pick-up is used, but it was found advisable to lighten the needle pressure somewhat to prevent excessive record wear. The pick-up is matched with a transformer to a 500-ohm line and bridged across the input of the speech amplifier feeding the transmitter with two 1000-ohm resistors. One section of a triple-pole single-throw switch connects the output of the pick-up through the transformer and bridge directly across the input of the speech amplifier without going through the regular mixing channel. Once the proper level is set by means of a 0.5 megohm potentiometer across the pick-up, it needs no further attention. The other section of



Controls for Exacting Applications

Controls required to meet the needs of exacting applications demand certain basic departures from conventional control design. Such departures are incorporated in IRC Type CS (standard) and Type DS (miniature) Controls. They include the IRC-pioneered Spiral Connector which entirely eliminates the conventional friction-contact "collector ring" with its obvious opportunities for the development of noise; the metallized-type element which, permanently bonded to a phenolic base, is highly resistant to moisture; and the 5-finger Contactor which

contacts the element over five separate paths with each finger operating independently in a cushioned "knee-action" effect. Each of these features has proved its superiority in countless difficult applications . . . each has proved its superiority under widely varying conditions of use. Add them to precision manufacture throughout, plus painstaking attention to so-called "minor" details, and you have the answer to the countless problems wherein conventional control performance, good as it may be, still leaves something to be desired.

AGEING

Control element is aged during processing, thus allowing less than 5% change in service.

NOISE

Spiral Connector entirely eliminates "collector ring" noise. 5-finger Contactor reduces contact noise to a minimum. IRC Controls have successfully replaced costly attenuators in various applications.

HUMIDITY

Exposure to the most humid climatic conditions for a long period causes positive change in range of approximately 10%. Controls return to initial value upon drying.

WEAR

Average change after 25,000 rotations is on the order of 5% and the increase in percentage is slight as rotations increase.



INTERNATIONAL RESISTANCE CO. 401 N. Broad St.
Philadelphia, Pa.

SOLAR

INDUSTRIAL and COMMUNICATIONS CAPACITORS

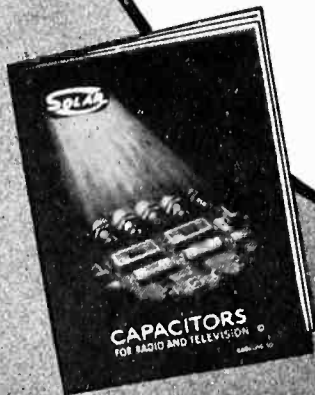
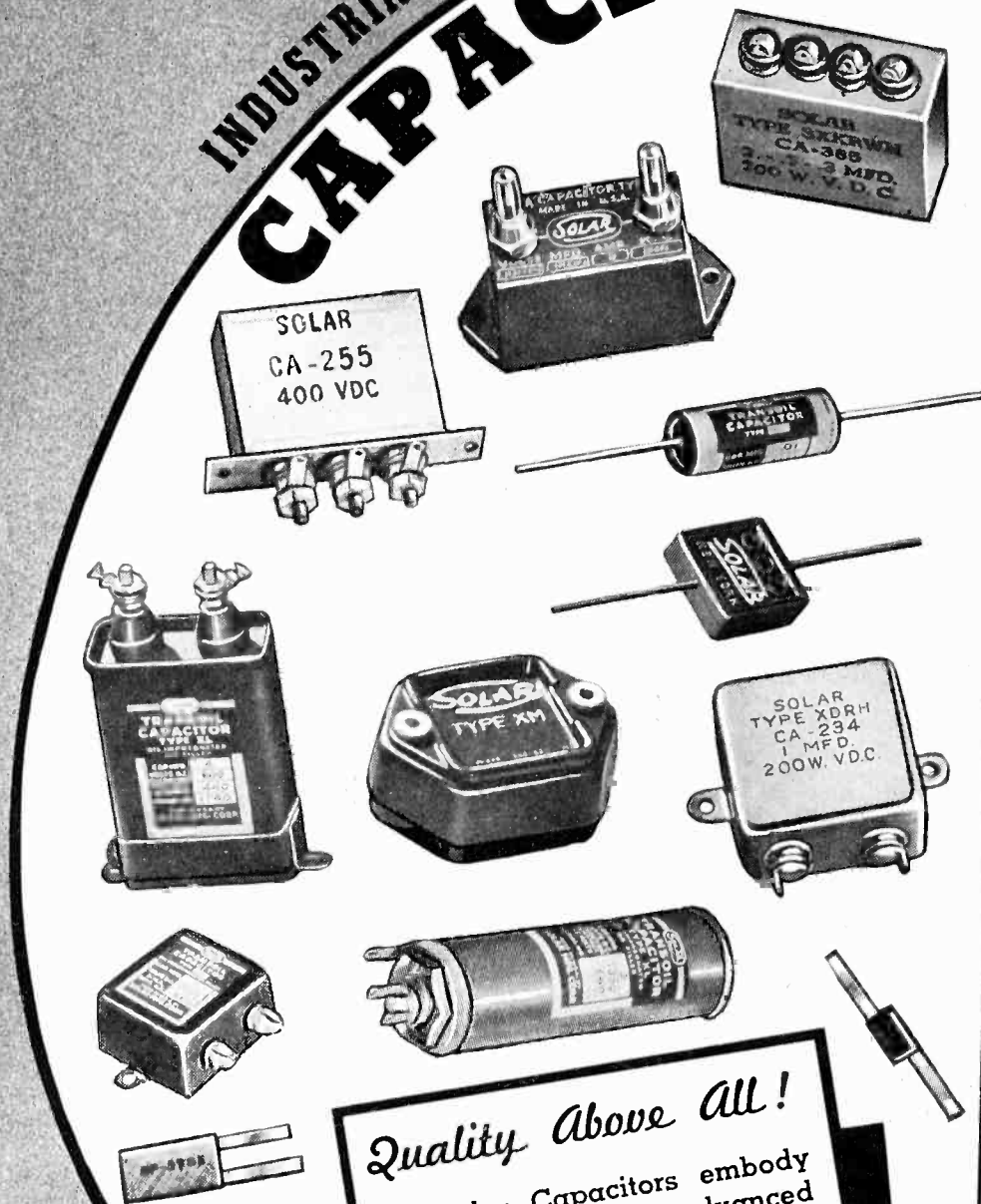

Quality Above All!
 All Solar Capacitors embody best materials and advanced manufacturing technique . . . tested and trusted by electrical leaders . . . our long and extensive experience is your warranty of *Quality Above All* . . . literature upon request . . . engineers upon call.

SOLAR MFG. CORP.
 Bayonne New Jersey

the triple-pole switch is connected to the turntable motor and its power supply. In this manner the output of the pick-up and the turntable motor are controlled simultaneously.

Using a twelve-inch blank, a station identification record is made in the following manner. The disk is cut continuously (33 rpm) for the maximum amount of time on the record (seven or eight minutes) while an announcer reads station identification announcements with a three second pause between each one. When this record is used on the equipment described, this interval allows sufficient time between station announcements to allow the turntable to come up to speed before an announcement begins and to allow the turntable to come to rest before running into the next one. Thus, by simply throwing the triple-pole switch, a station "break" may be taken after which the switch is opened and the equipment is ready for the next one. With an average of three seconds allowed for each station "break" and with a three second interval between each one as many as forty or fifty station "breaks" may be "cut" on one twelve inch record. This is enough for several days use before the pick-up has to be set back to the beginning of the record. Some means of warning when the last announcement on the record is reached is advisable. This is accomplished by simply altering the last announcement somewhat so as to distinguish it from the others.

The entire equipment is completely enclosed in a dust proof box measuring 14 by 8 inches. A single record should last many months before it becomes noticeably noisy.

• • •

CYCLOTRON CONTROL BOARD

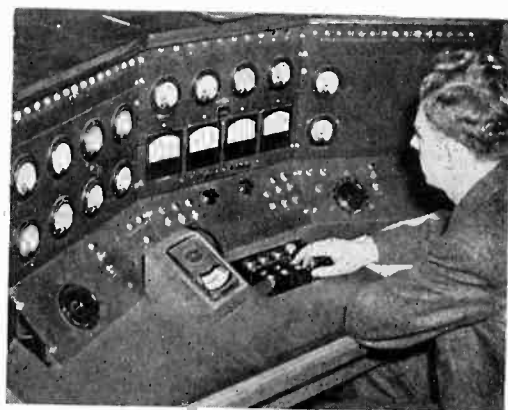

Dr. Arthur J. Snell at the control board of the University of Chicago's improved 80-ton cyclotron. Because of the harmful action of this 8,000,000-volt apparatus, the board is located in a room away from the cyclotron. When completed, the apparatus will be equipped to make artificially radioactive elements used in medical, biochemical and dental departments of the University

PEAKS..

These mountain peaks rise with majestic ease —simulating the behavior of UNITED rectifiers on the "high end" of their inverse peak ratings.

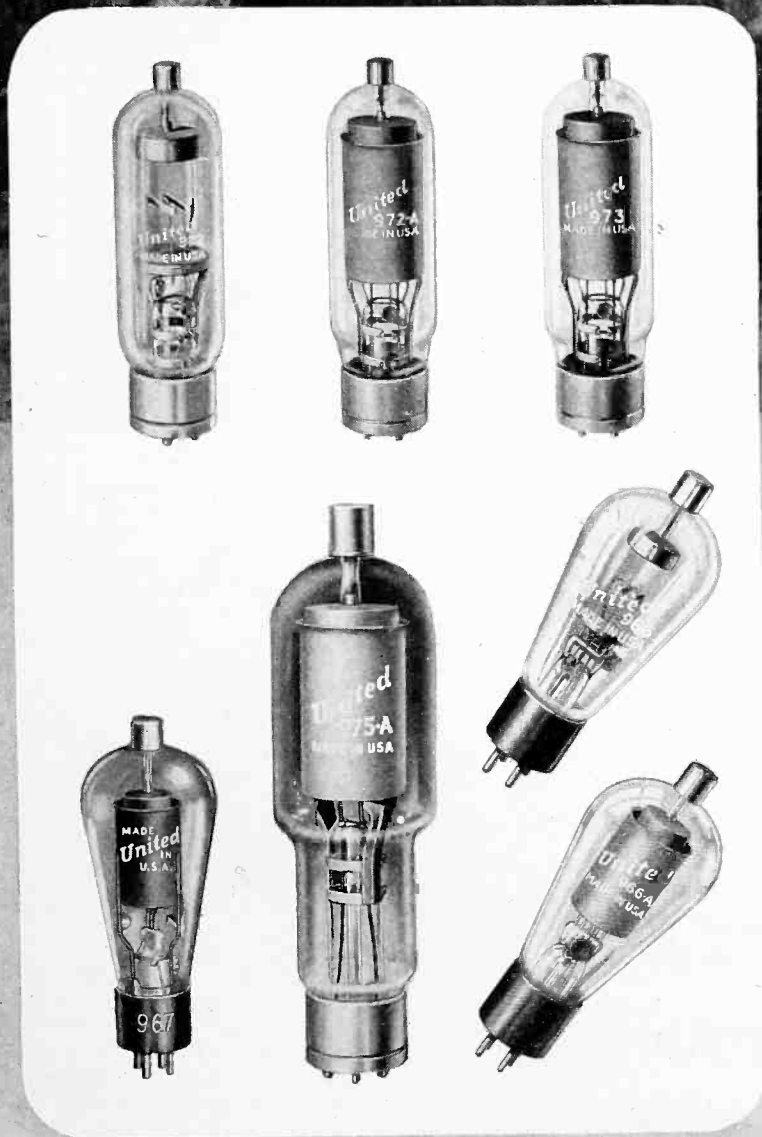

Today, as for many years past, UNITED mercury rectifiers represent the peak of performance and service life. Engineers, experienced in the fine points of electron tube design, appraise new tubes only in terms relative to UNITED standards.

Professional as well as amateur demand for these famous high-voltage tubes is now greater than ever before.

966. Half-wave rectifier with unobstructed cathode. Starting voltage and pre-heating time lower than any known tube of this type. Measured mercury content. Price \$1.20

966A. Similar to above, except with fully shielded cathode. Price \$1.50

967. Grid control rectifier, for CW keying, industrial and various control applications. Price \$4.50

973. Grid control rectifier with higher power rating than 967. Price \$17.25

972. Half-wave rectifier with unobstructed cathode. Peak plate current 5 amps., average 1.25 amps. Price \$9.00

972A. Similar to above, except with fully shielded cathode. Price \$11.00

975A. High power type; shielded, 15,000 volts inverse, peak plate current 6 amps. Price \$27.50

Write for detailed data describing UNITED rectifiers, as well as heavy duty air-cooled transmitting types for Broadcast, communication and industrial uses.

UNITED ELECTRONICS COMPANY

42 SPRING STREET



NEWARK, NEW JERSEY



ELECTRIC CONTROLS FOR EVERY PURPOSE FROM ONE SUPPLIER

With motors and machine tools operating at capacity today, dependability, efficiency and conveniences of electric controls take on new importance. For nearly fifty years Ward Leonard has developed controls ahead of the requirements of industry. In the Ward Leonard Line you will find not only the control that exactly meets your requirements but one that assures the dependable and maximum operation of the equipment it serves.

Specific Bulletins are available covering Motor Starters, Controllers and Speed Regulators large and small, Relays of various types and contact combinations, Resistors and Rheostats for every industrial and communication service. Send for Bulletins of interest to you.

WARD LEONARD

ELECTRIC COMPANY

Electric Control Devices Since 1892

WARD LEONARD ELECTRIC CO., 34 South Street, Mount Vernon, N. Y.

Please send me Bulletin describing Relays () Resistors () Rheostats () Motor Starters and Controllers () Speed Regulators ().

Name

Firm

Address

City State



A Practical Audio Bridge Circuit

By WILLARD MOODY

THE WIEN BRIDGE, USING PRECISION resistance standards, may be accurate to within 0.003 per cent in the audio range. The frequency coverage with sensitive, high-impedance earphones is from approximately 300 to 5,000 cycles per second, but better results are secured when a sensitive a-c voltmeter or vacuum tube voltmeter is used for balance indication. With meter indication the range may be from 20 to 20,000 cycles per second with good accuracy.

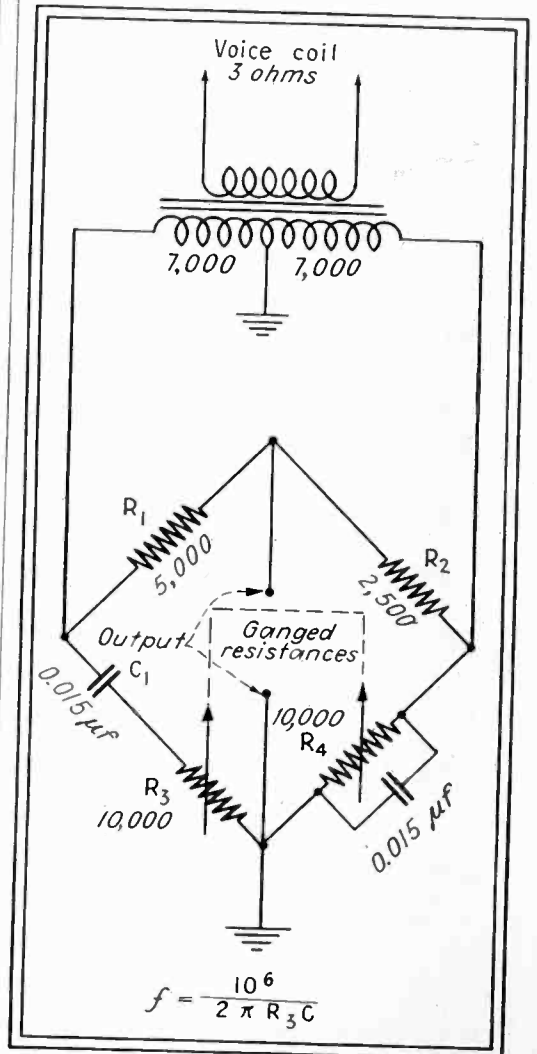

Fig. 1—Circuit of the audio bridge

In Fig. 1 is shown the circuit used by the writer, which was intended for analysis of the output voltage of a radio receiver. The frequency for which the bridge is balanced is given by the simple equation shown. R_3 and R_4 are a dual potentiometer, or ganged volume control of two wire-wound sections. This control is fitted with an accurate dial and the resistance readings, measured by an ohmmeter or other means, are plotted against the dial figures. The various frequencies corresponding to the dial settings are then calculated and tabulated on a convenient reference card which is attached to the instrument. The bridge may be used for precise determination of frequency and will serve as a check

A LOOK AT THE RECORD



Five years ago. Presto offered the first high fidelity instantaneous recording equipment to radio stations. Today, more radio stations use Presto recording equipment than any other make.

Today, radio stations have a larger investment in Presto equipment than in all other makes of recording equipment combined.

We want to express our thanks to the hundreds of broadcast engineers whose endorsement of

Presto equipment has given us this outstanding position in the recording field. More particularly, we want to thank those engineers whose practical suggestions have helped us adapt Presto equipment to the exacting requirements of station operation.

Shown here are some new Presto developments which will further improve the performance of your recording installation.

PRESTO EQUIP FOR SOUND RECORDING



1. Presto 1-C cutter gives wider response range, higher playback level from Presto recordings. Can exchange for Presto 1-B cutter at low cost.



2. Presto 6-N recording turntable for portable or fixed recording installations. A great improvement over the standard 6-D table, less vibration, wider frequency response.

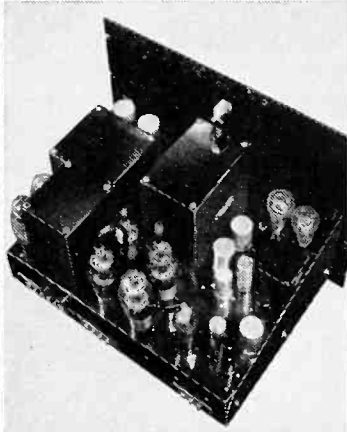

3. Presto 88-A, 50 watt recording amplifier. Selector switch pre-emphasizes high-frequency response to record NBC Orthacoustic or standard high fidelity lateral characteristic. Gain 85 db, 1% distortion.



4. Presto 8-N recorder, the finest recording turntable made by Presto. Used by the larger stations in U. S. and Canada. Records made on the 8-N reproduce uniformly range 50-9000 C. P. S. Noise level -50 db.



5. Presto 62-A transcription table, called by leading engineers the quietest, steadiest table on the market. Selector switch adjusts pickup response instantly for any type lateral recording.

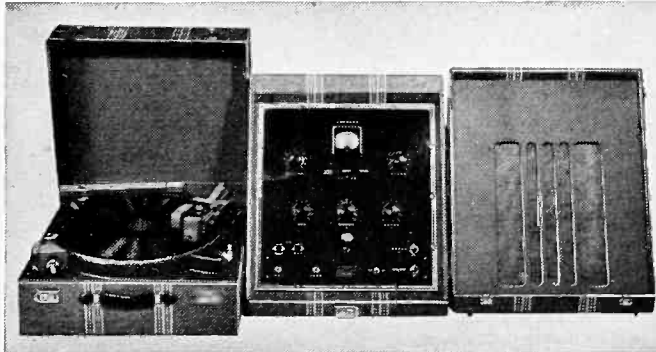

6. Presto model Y recorder, used by scores of stations for outside pickups. Makes high quality 16" transcriptions suitable for broadcasting.

7. Presto recording discs, greatly improved by new manufacturing process to have more uniform coating, lower surface noise, wider frequency range, higher playback level.



8. Presto model L portable playback, lightweight, simple to operate, gives perfect reproduction of all types of lateral recordings. Ideal for time salesmen and agency executives.

KALE	KPHO	WCOL	WKAQ
KANS	KPO	WCOU	WKBZ
KBTM	KPQ	WDAN	WKPT
KCMO	KRGV	WDAY	WLAK
KDKA	KRIS	WDBJ	WLBC
KDYL	KRLC	WDBO	WLBZ
KEVR	KSD	WDGY	WLEU
KFBK	KSEI	WDZ	WLLH
KFKA	KSL	WEAF	WLLO
KFH	KSRO	WEBC	WLTH
KFI	KSUN	WEFI	WMAL
KFJI	KTFI	WFAS	WMAZ
KFJM	KTKC	WFBG	WMBD
KFNF	KTRB	WFBL	WMBI
KFPW	KTUC	WFIG	WMBO
KFPY	KUJ	WFMD	WMC
KFUO	KUTA	WFTC	WMFG
KFWB	KVOO	WGAC	WMIN
KGA	KVOS	WGBR	WMPC
KGDE	KVOX	WGH	WMSD
KGER	KVSF	WGL	WNBH
KGGF	KWSC	WGN	WNLC
KGGM	KXRO	WGTM	WOR
KGHF	KXYZ	WHAM	WORL
KGIR	KYA	WHEB	WOW
KGKO	WAAT	WHEC	WOWO
KGMB	WAGM	WHKC	WPAX
KGNO	WAIM	WHO	WPIC
KGO	WAIR	WHP	WPRO
KGVO	WBAP	WIBW	WRC
KHQ	WBLK	WIBX	WSAV
KIDO	WBNS	WICA	WSB
KIEM	WBNY	WICC	WSM
KITE	WBOC	WIL	WSFA
KIUN	WBRB	WING	WSOC
KLAH	WBRC	WINN	WSOO
KLZ	WBRK	WIRE	WSTV
KMBC	WBRW	WISN	WTAM
KMOX	WBT	WJAC	WTAQ
KMPC	WBTM	WJBC	WTCN
KOA	WCAP	WJLS	WTHT
KOIN	WCAU	WJNO	WTIC
KOME	WCCO	WJR	WTOC
KOMO	WCHS	WJTN	WWNC
KPFA	WCKY	WJZ	WXYZ

VISIT THE PRESTO NAB
CONVENTION EXHIBIT
ROOMS 664-8, HOTEL
JEFFERSON

PRESTO RECORDING CORPORATION

242 WEST 55th STREET, NEW YORK, N. Y.

World's Largest Manufacturers of Instantaneous Sound Recording Equipment and Discs.

Wherever Performance Is Of Prime Importance

DAVEN ATTENUATORS

To the design and construction of each unit, DAVEN engineers and craftsmen apply the conviction that every problem requires the best solution that specialized skill can offer.

This true craftsmanship gives each detail its rightful attention and makes all details total to a product that is rightfully "tops" in its field.

The DAVEN catalog lists the most complete line of precision attenuators in the world; "Ladder", "T" type and "Balanced H" networks—both variable and fixed types—employed extensively in control positions of high quality program distribution systems and as laboratory standards of attenuation.

Super DAVOHM resistors are precision type, wire-wound units of from 1% to 0.1% accuracy.

More than 80 models of Laboratory Test Equipment are listed.

However, due to the specialized nature of high fidelity audio equipment, a large number of requirements are encountered where stock units may not be suitable. If you have such a problem, write to our engineering department.

THE DAVEN COMPANY
158 SUMMIT STREET • NEWARK, NEW JERSEY

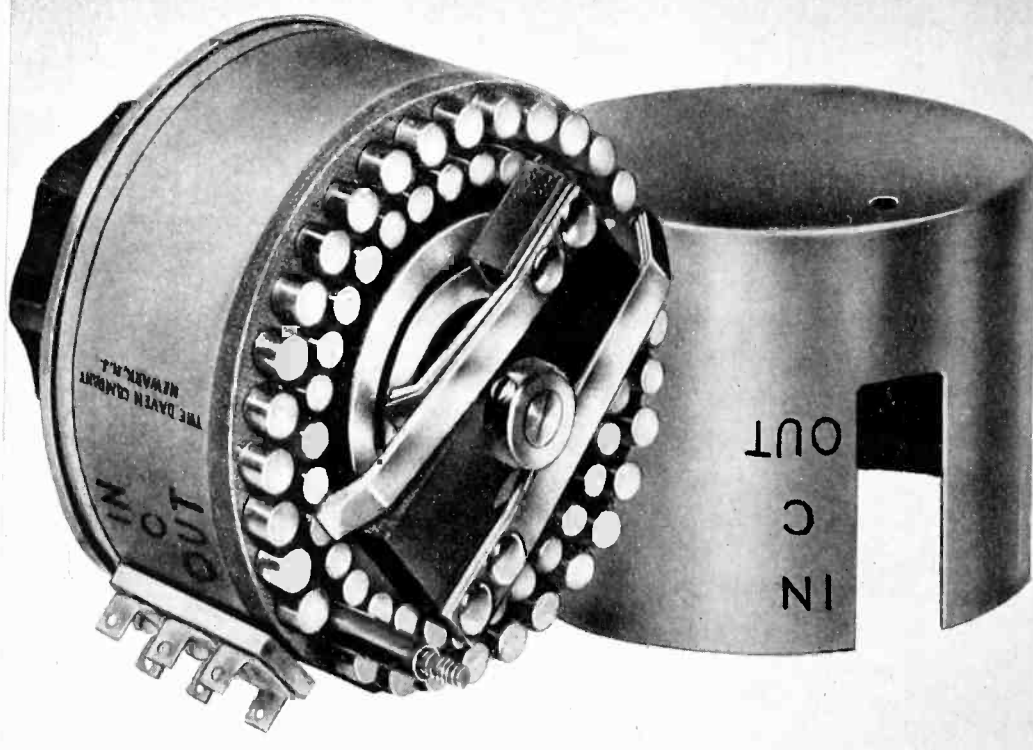

on other apparatus or as a calibrator of audio oscillators. Many other uses will suggest themselves in the laboratory or shop.

The parts used in constructing the unit will have an important effect on the accuracy, and should be of good quality. Any standard output transformer of correct impedance and linear frequency characteristic, within practical limits, may be used. The total cost about \$5.00, exclusive of balance indicator.

Notes on Hum Neutralization in Loud Speakers

By C. E. HOEKSTRA
The Magnavox Company

OF THE TWO METHODS of speaker hum control, the most common in the automotive field is the copper hum slug. Most common in the high resistance fields is the neutralizing coil. The hum slug reduces the ripple voltage induced in the voice coil by increasing the effective field coil impedance. This increased field coil impedance reduces the variations in excitation current of the field coil and, in effect, reduces the ripple voltage induced in the voice coil circuit. The hum slug increases the phase angle between the voltages induced in the voice coil and neutralizing coil. The effectiveness of the hum slug in reducing the voice coil induced voltage increases with an increase in ripple frequency.

The neutralizing coil is a winding placed electrically in series with the speaker voice coil and mechanically in the speaker field structure in such a manner that the ripple voltage induced in the voice coil and in this auxiliary winding is of such magnitude and

BAIRD DEVELOPS COLOR TELEVISION



John L. Baird, pioneer in television, has developed a method for showing television pictures in full natural colors. The set can receive pictures in color or black and white. Shown here is Miss Hattie Nasmith, airwoman and racing motorist being televised at a Baird color camera studio. Apparently not all television development has been stopped in England

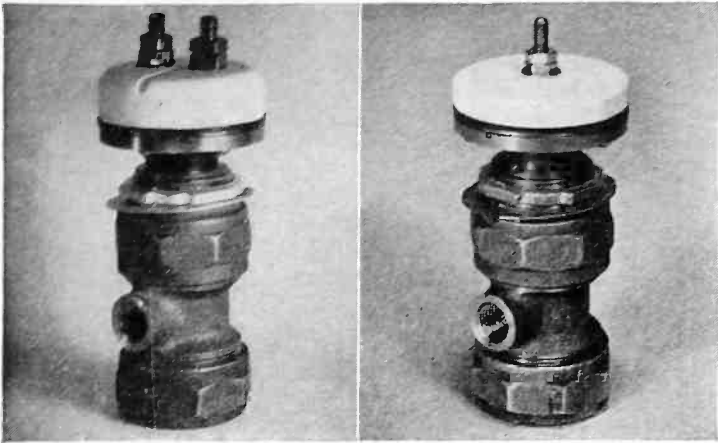

(Above) NEW FLARE TYPE END SEALS have been added to Isolantite's comprehensive list of fittings for transmission lines. End seal at left is for new balanced two-wire lines while fitting at right is for the coaxial lines. These new flare type end seals are for use in ultra high frequency service, such as frequency modulation, television, airport beacons, and special applications.

(Below) CONCENTRIC TRANSMISSION lines built by Isolantite serve Westinghouse 50KW Station WBZ and WIXK, the new FM transmitter at Hull, Mass. Isolantite $2\frac{5}{8}$ " diameter transmission line provides maximum safety factor for high power broadcast and minimum attenuation for ultra high frequency FM service.

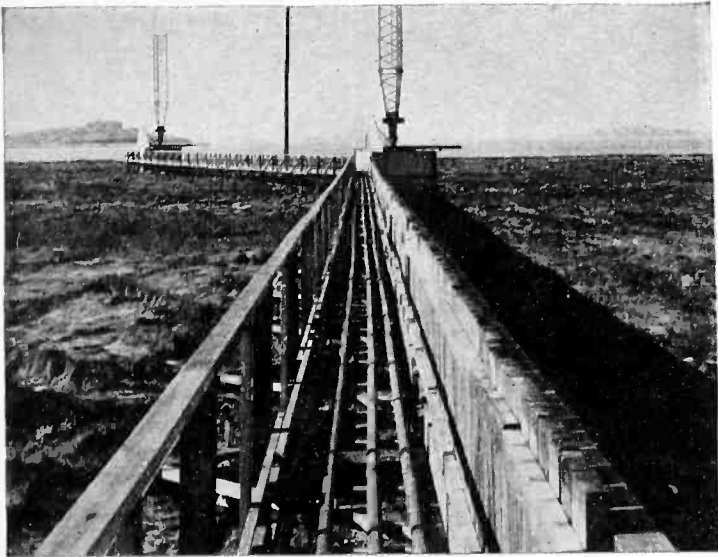

(Below) HIGH STRENGTH AND RIGIDITY of Isolantite make it particularly adaptable to applications where insulators are subjected to continual fatigue or repeated mechanical stresses. These mechanical features, in addition to its availability in custom built shapes, are exemplified by its use as a shaft coupling in this tower light M-G set at Station WDAF, Kansas City.

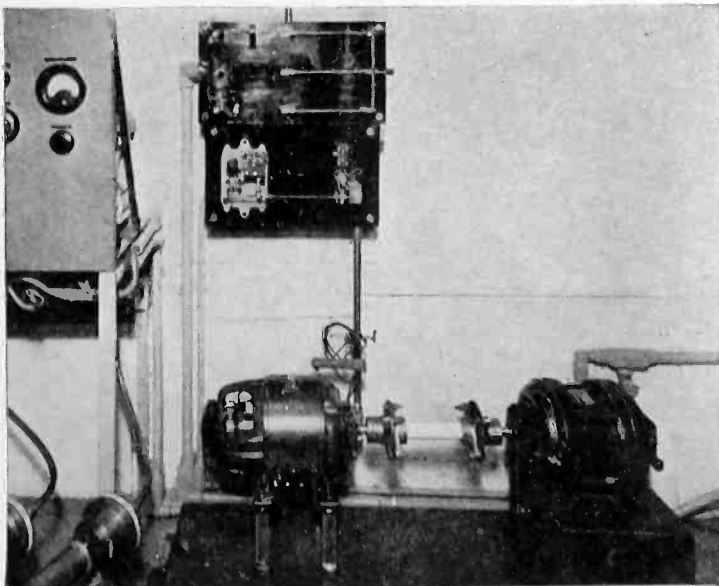

INSULATION HIGHLIGHTS

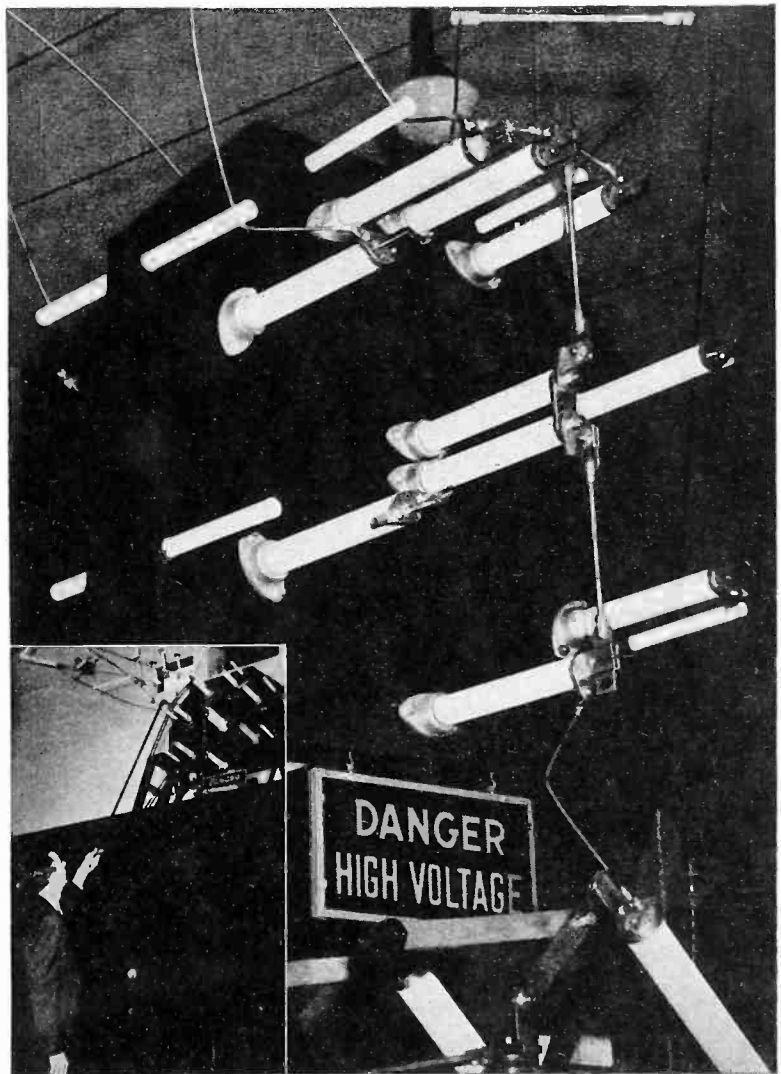

(Above) STAND-OFF INSULATORS of Isolantite are used extensively at the Lawrenceville, N. J., station of the American Telephone and Telegraph Company's Long Lines Department. Photos show front and rear views of antenna selector switch panel on South American lines. This use of Isolantite in overseas radio-telephone equipment is typical of the ways in which it serves every major branch of the communications industry.

**Registered trade-name for the products of Isolantite, Inc.*

ISOLANTITE

CERAMIC INSULATORS

ISOLANTITE, INC. FACTORY: BELLEVILLE, NEW JERSEY
SALES OFFICES: 233 BROADWAY, NEW YORK, N. Y.

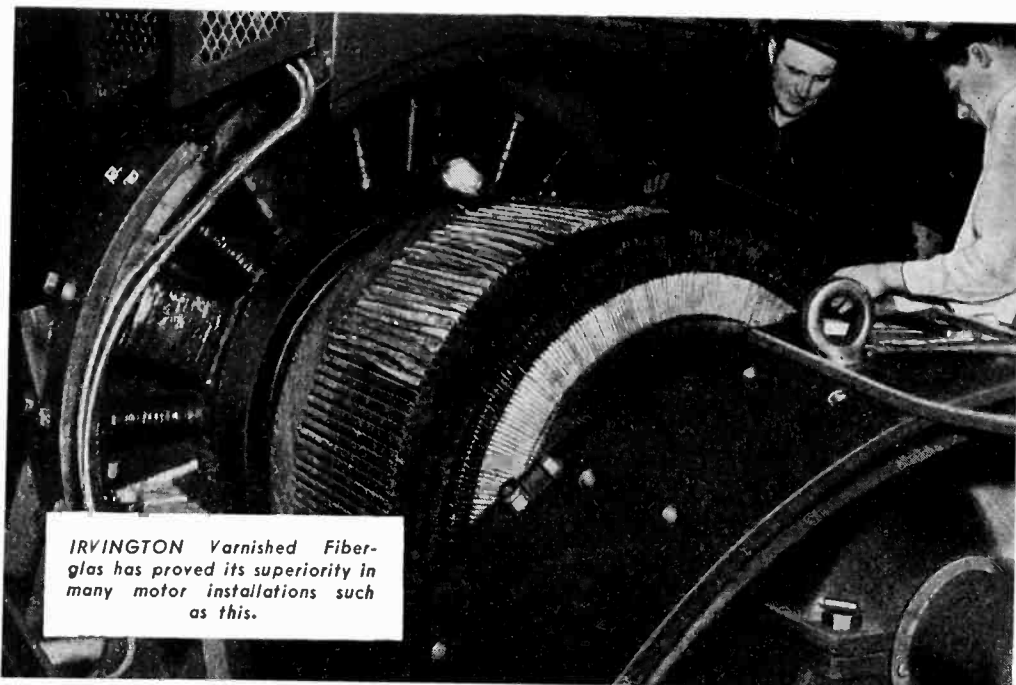

IRVINGTON Varnished Fiberglass has proved its superiority in many motor installations such as this.

IRVINGTON VARNISHED FIBERGLAS

Better Insulation More Easily Applied

IRVINGTON Varnished Fiberglass makes powerful motors smaller and lighter and tiny instruments more efficient and long-lived. It allows hundreds of types of electrical equipment to operate more efficiently, for more years, at higher temperatures, with greater resistance to attacking elements.

IRVINGTON Varnished Fiberglass is properly impregnated and coated with insulating varnish of highest grade to withstand the severe abuse which Fiberglass permits.

Here is glass cloth, woven from continuous fibers as manufactured by Owens-Corning Fiberglass Corporation; then thoroughly impregnated and coated by "Irvington" with high heat resisting black or clear insulating varnishes developed especially for this purpose.

To secure the benefits of highest insulation resistance, resistance to impact and abrasion, and the best balance in overall mechanical, electrical and chemical characteristics, the Fiberglass you use should be factory impregnated by "Irvington's" modern methods and with IRVINGTON High Heat Resisting Insulating Varnishes.

This superior product comes to you all ready to go in place, eliminating costly, time-consuming varnish impregnation and coating operations in your plant.

Detailed technical data and specifications for standard IRVINGTON Varnished Fiberglass cloths and tapes are yours for the asking. Write to Dept. 106. Data will gladly be furnished on the development and production of special combinations of Fiberglass cloth and varnish.

IRVINGTON VARNISH & INSULATOR CO.



IRVINGTON, NEW JERSEY, U. S. A.
PLANTS AT IRVINGTON, N. J. and HAMILTON, ONT., CAN.
Representatives in 20 Principal Cities

phase that the net induced voltage across the combination is the value desired. In general it is required that this net voltage be as near zero as practical. The neutralizing coil is most effective at low frequencies.

The net voltage across the voice coil-neutralizing coil circuit does not in itself result in hum. The current which flows in the voice coil circuit is that which results in hum. The degree to which a given net voltage causes hum is primarily dependent upon the impedance in shunt with the voice coil. This shunt impedance is the shunt impedance of the output transformer in parallel with the plate resistance of the output stage. In a triode (or tetrode with inverse feed-back) the stage impedance will be low, and in general of such magnitude that it is smaller than the primary reactance of the transformer. The conventional tetrode and pentode stage has a high internal impedance so that the load on the voice coil is made up primarily of the transformer's shunt impedance. It is obvious that for minimum speaker field hum the a-c impedance of the field coil should be high, the shunt reactance of the output transformer high, and the alternating voltage across the field coil as low as practicable. The vector diagram in Fig. 1A shows the voltages induced in the voice coil and neutralizing coil windings. The net voltage is that which may cause current to flow in speaker's shunt impedance and so result in hum.

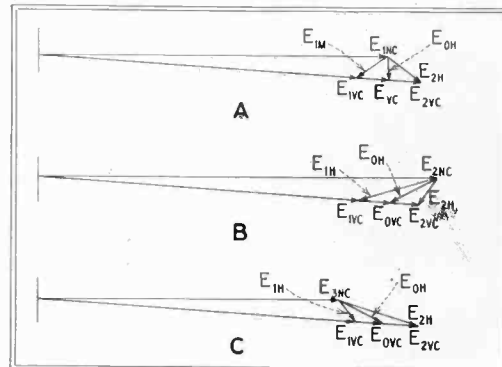
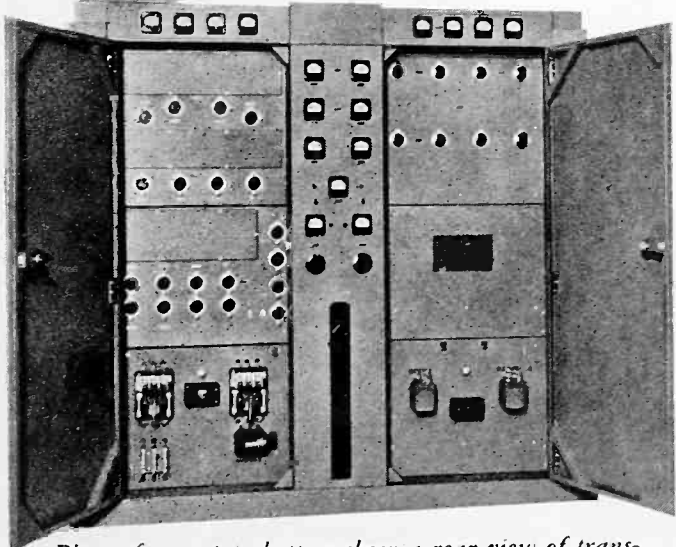
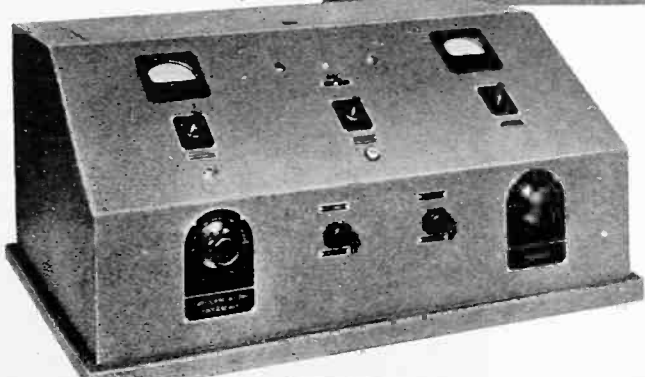
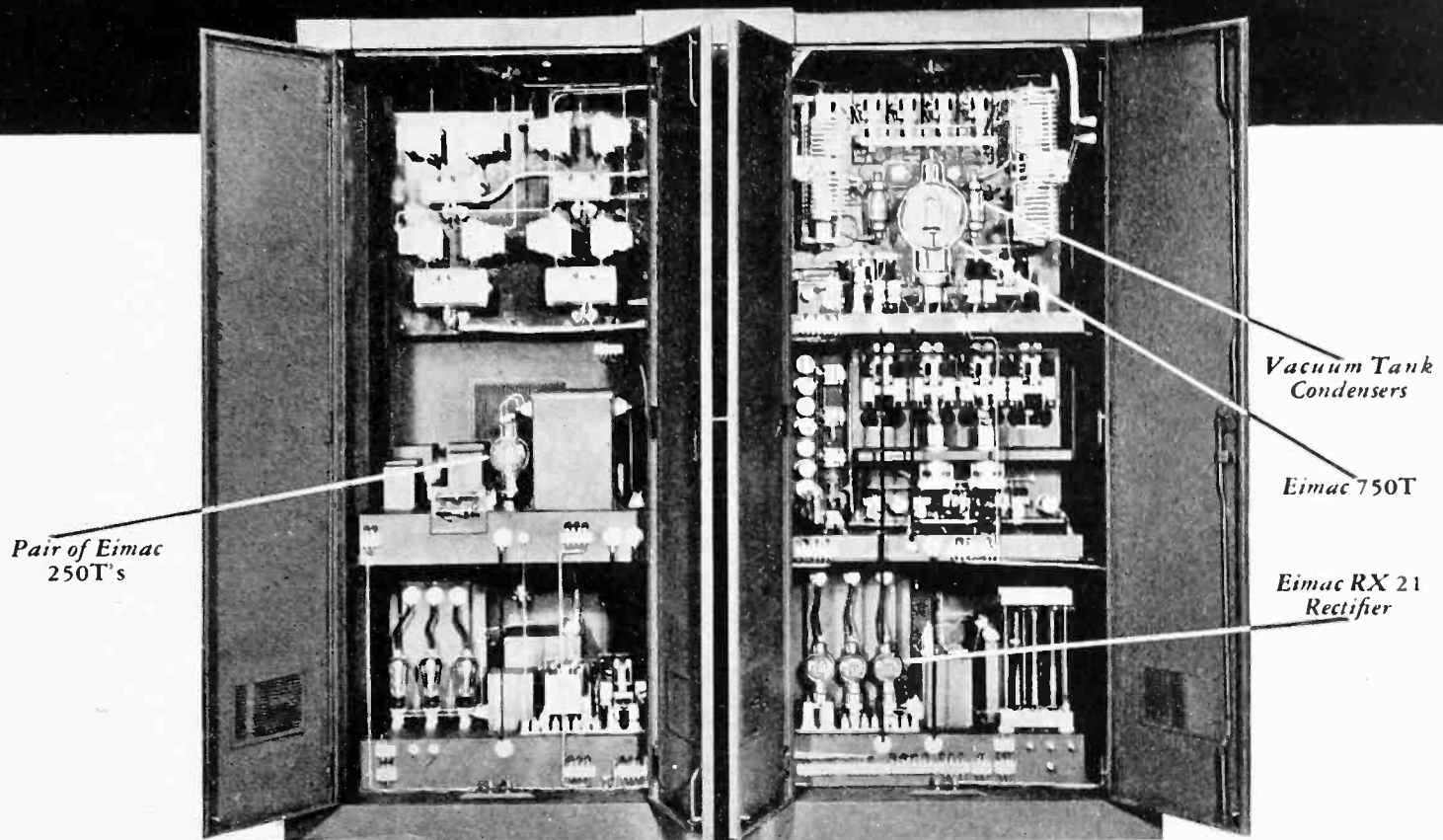

Fig. 1—Vector diagrams of the voltages in a loudspeaker

In a large lot of similar speakers the value of E_{1nc} is fixed but the value of E_{vc} induced in the voice coil may vary. The value of E_{vc} depends upon the axial spacing of the voice coil in the field structure gap. The farther "down" in the gap the greater is its value. This variation in the location of the voice coil in the gap results from mechanical variations in the speaker parts. Temperature and humidity will also influence the voice coil's axial location. These variations will give us values of E_{vc} between E_{1vc} and E_{2vc} . Hence the hum voltage will vary between E_{1m} and E_{2h} . E_{oh} is the minimum hum voltage possible.

The value of E_{oh} is determined by the design of the speaker field structure. The smaller the phase angle between E_{vc} and E_{1nc} the smaller E_{oh} can be made.

EIMAC EQUIPPED BRAZILIAN ARMY STATION



Photos from top to bottom show a rear view of transmitter, the remote control and a front view of the transmitter constructed by Maya Rebello & Comp. of Rio de Janeiro for the Brazilian army

Here is supporting evidence of the fact that Eimac Tubes have world-wide acceptance, even by foreign government owned radio station.

With a single 750T in the final stage and a pair of 250T's as modulators this station puts 1200 watts on the antenna. Operated by remote control on four frequencies using phone, CW and ICW.

The transmitter was constructed by Maya Rebello & Comp. of Rio de Janeiro and employs Eimac RX 21 rectifier tubes as well as Eimac vacuum tank condensers in the final circuit. The design and construction does credit to its makers and the use of Eimac Tubes in the most important sockets is convincing evidence of their superiority and position in the world of radio.

Follow the Leaders to

Eimac
TUBES

EITEL-McCULLOUGH, INC. • SAN BRUNO, CALIFORNIA

Export Agents: Frazar & Co., Ltd., 301 Clay St., San Francisco

MATHEMATICS

OF ELECTRICAL CONTROL

SUBTRACT — PRIORITY MATERIALS

DIVIDE ÷ MAN HOURS INTO MINUTES

MULTIPLY × MACHINE PRODUCTION



Add + EFFICIENCY TO YOUR PRODUCT . . .

★ You, and your engineers are doing some serious thinking. With machines and skilled workers practically unavailable, and essential materials being rationed, you'll have to make some changes. Want to eliminate priority materials, cut machine time, and make the most of available man-hours? Consider

RELAYS... by GUARDIAN

Perhaps you've never thought of electrical control for your product—but now you may be forced into it. If you are, there's no use making the change unless you can get new parts . . . "but quick." Guardian can do a good job—fast! If you use Guardian Electric controls, and more people do every day . . . we can eliminate large amounts of expensive hard-to-get materials . . . reduce machine and assembly time . . . overcome dissipated action and friction drag of outmoded mechanical controls with better performance assured in the bargain.

*7,146 STANDARD GUARDIAN CONTROL PARTS

Capitalize upon thousands of hours already spent designing *7,146 standard control parts which enable Guardian Electric Engineers to quickly provide a SAMPLE control unit for comparison with and immediate replacement of your present control system. Just what you need? (In 99 out of 100 times Guardian gives the correct answer!) Yes, it's highly probable . . . seldom impossible at Guardian.

*Inventory Count Jan. 1, 1941

SPEED—the goal of every production manager excels any service you've ever heard of . . . at Guardian.

Initial Your Letterhead For New
1941 Catalog "E" Today. Write

GUARDIAN  **ELECTRIC**

1625 West Walnut Street

- INTERLOCKING CONTROLS
- RADIO CONTROLS
- LIQUID LEVEL
- AIRPLANE CONTROLS
- COMMUNICATIONS
- TIMING CONTROLS
- STEPPING RELAYS
- U. S. GOVERNMENT SPECIFIED CONTROLS
- CONTACT SWITCHES
- COUNTING UNITS
- REMOTE CONTROLS
- SOLENOIDS
- DELAYED ACTION

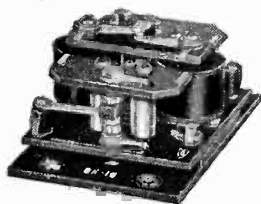

Series BK—16 Relay. Built to minimum tolerances and the most exacting requirements in production quantities for the U. S. Signal Corps.

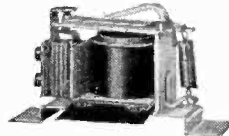

Series 120 AC Relay. This relay which sells for less than \$1 has operated over 85,000,000 times in an electric fence control, and still remains in excellent condition.

And These Are Not the Extremes
in the Guardian Relay Line!

Chicago, Illinois

Figures 1B and 1C demonstrate special cases of hum neutralization. In certain instances speaker hum is used to balance out all, or a part of, the hum from the speaker's output stage. The speaker in Fig. 1B is said to be overbucked. The voltage induced in the neutralizing coil is enough greater than that induced in the voice coil so that the phase angle of the net voltage and that induced in the neutralizing coil is less than 90 degrees. The speaker in Fig. 1C is said to be underbucked. The voltage induced in the neutralizing coil is enough less than that induced in the voice coil so that the phase angle of the net voltage and that induced in the neutralizing coil is greater than 90 degrees.

The degree of hum bucking can be expressed in two ways. We may state that the degree of hum bucking is

$$100 \times \frac{\text{neutralizing coil induced voltage}}{\text{voice coil induced voltage}}$$

Or, we may state that the unbalance is

$$100 \times \frac{\text{net induced voltage}}{\text{neutralizing coil induced voltage}}$$

and specify (if the speaker is overbucked or underbucked) that the neutralizing coil induced voltage is greater or less than the voice coil induced voltage. The degree of unbalance is expressed in terms of the neutralizing coil induced voltage since this is the only "fixed" voltage on that lot of similar speakers. A fair commercial tolerance on the degree of unbalance is 15 per cent and on the range of unbalance in an overbucked and underbucked speaker 30 per cent.

• • •

ARMY OFFICERS INSPECT POLICE RADIO SYSTEM



Major J. H. Stodter (left) and Major B. M. Nelson (right) in charge of communication school at Fort Riley, Kansas look as Roy Deschaffron, superintendent of communications of Kansas City Police, explains his latest radio equipment

TUBES

Data on new receiving tubes registered by the R.M.A. Data Bureau are presented, as well as data on older tubes which are given for reference

Tube Registry

Tube Types registered by R.M.A. Data Bureau During March 1941

Type 6SN7GT

TWIN triode; heater type; T-9 glass envelope; seated height 2 $\frac{3}{4}$ inches (max); 8-pin octal base.

RATINGS
 $E_h = 6.3$ v
 $I_h = 0.6$ amp
 $E_b = 300$ v (max)
 $E_c = 0$ v (min)
 $P_o = 2.5$ watts (max)

OPERATION
 $E_b = 250$ v
 $E_c = -8$ v
 $I_b = 9$ ma
 $\mu = 20$
 $r_p = 7700$ ohms
 $g_m = 2600$ μ hos

TRIODE 1
 $C_{in} = 3.2$ μ uf
 $C_{out} = 3.4$ μ uf
 $C_{sp} = 4$ μ uf

TRIODE 2
 $C_{in} = 3.8$ μ uf
 $C_{out} = 2.6$ μ uf
 $C_{sp} = 4$ μ uf
 Basing 8BD-0-0

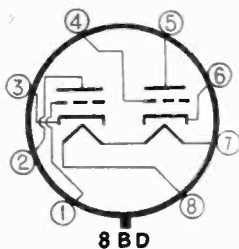

Type 7R7 (GL)

DOUBLE diode, pentode, remote cutoff; heater type; T-9 integral glass envelope-base; seated height 2 $\frac{1}{4}$ (max); 8-pin lock-in base.

RATINGS
 $E_h = 7.0$ v
 $I_h = 0.320$ amp
 $E_b = 250$ v (max)
 $E_{c2} = 100$ v (max)
 $E_c = 0$ v (min)

OPERATION
 $E_h = 6.3$ v
 $I_h = 0.3$ amp
 $E_b = 250$ v
 $E_{c2} = 100$ v
 $E_c = -1$ v
 $I_b = 5.7$ ma
 $I_{c2} = 2.1$ ma
 $g_m = 3200$ μ hos
 $r_p = 1$ megohm (approx)

$C_{in} = 5.6$ μ uf
 $C_{out} = 5.3$ μ uf
 $C_{sp} = 0.004$ μ uf (max)
 Basing 8AE-L-7

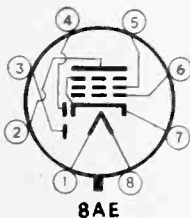

Type 12SF7 (M)

DIODE, pentode, remote cutoff; heater type; MT-8 metal envelope; seated height 2 $\frac{1}{4}$ inches (max); 8-pin octal wafer base.

$E_h = 12.6$ v
 $I_h = 0.15$ amp
 $E_b = 250$ v
 $E_{c2} = 100$ v
 $E_c = -1$ v
 $I_b = 12.4$ ma
 $I_{c2} = 3.3$ ma
 $g_m = 2050$ μ hos
 $r_p = 0.7$ megohm
 $g_m @ -35$ v = 10 μ hos

$C_{in} = 5.5$ μ uf
 $C_{out} = 6.5$ μ uf
 $C_{sp} = 0.004$ μ uf (max)
 Basing 7AZ-1-1

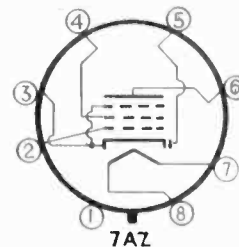

Type 14R7 (GL)

DOUBLE diode, pentode, remote cutoff; heater type; T-9 integral glass envelope-base; seated height 2 $\frac{1}{4}$ inches; 8-pin lock-in base.

RATINGS
 $E_h = 14.0$ v
 $I_h = 0.160$ amp
 $E_b = 250$ v
 $E_{c2} = 100$ v (max)
 $E_c = 0$ v (min)

OPERATION
 $E_h = 12.6$ v
 $I_h = 0.150$ amp
 $E_b = 250$ v (max)
 $E_{c2} = 100$ v (max)
 $E_c = -1$ v
 $I_b = 5.7$ ma
 $I_{c2} = 2.1$ ma
 $g_m = 3200$ μ hos
 $r_p = 1$ megohm (approx)

$C_{in} = 5.6$ μ uf
 $C_{out} = 5.3$ μ uf
 $C_{sp} = 0.004$ μ uf (max)
 Basing 8AE-L-7

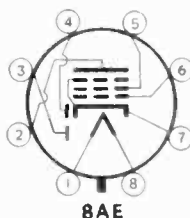

Type 6SF7 (M)

DIODE, pentode, remote cutoff; heater type; MT-8 metal envelope; seated height 2 $\frac{1}{4}$ inches (max); 8-pin octal wafer base.

$E_h = 6.3$ v
 $I_h = 0.3$ amp
 $E_b = 250$ v
 $E_{c2} = 100$ v
 $E_c = -1$ v
 $I_b = 12.4$ ma
 $I_{c2} = 3.3$ ma
 $g_m = 2050$ μ hos
 $r_p = 0.7$ megohm
 $g_m @ -35$ v = 10 μ hos

$C_{in} = 5.5$ μ uf
 $C_{out} = 6.5$ μ uf
 $C_{sp} = 0.004$ μ uf (max)
 Basing 7AZ-1-1

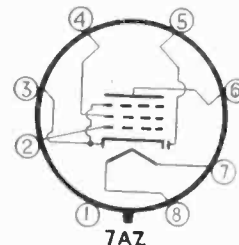

FIELD WORK IN COMMUNICATIONS

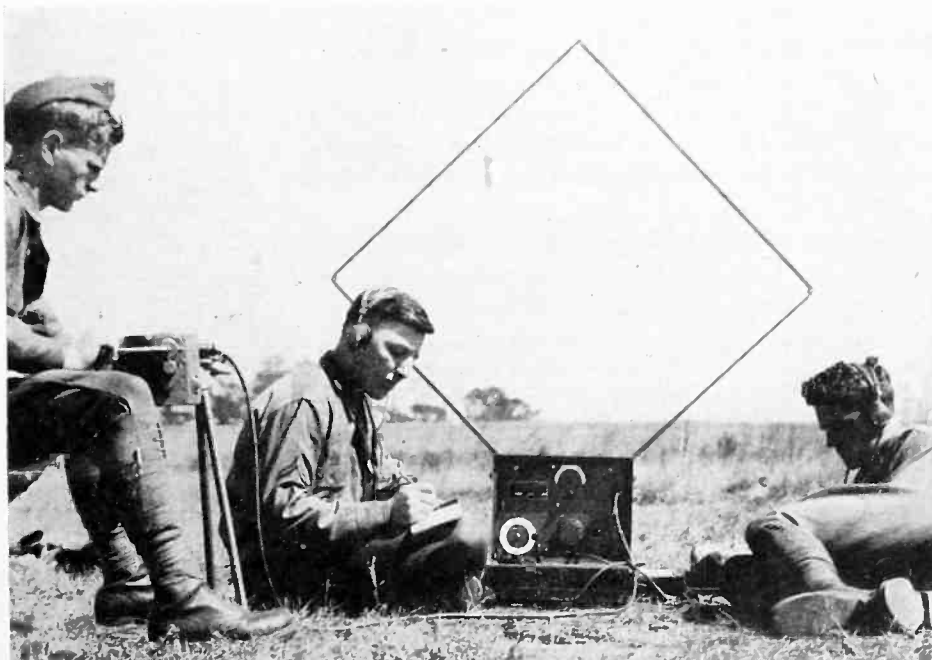

Soldiers at the Infantry School at Fort Benning, Ga. are taught the principles of radio communications through actual practice. Here three soldiers are operating a portable field set. The operator at the left is generating power with a hand operated generator

LITTLE but **TOUGH!**



STACKPOLE Model SS-12 SLIDE SWITCH

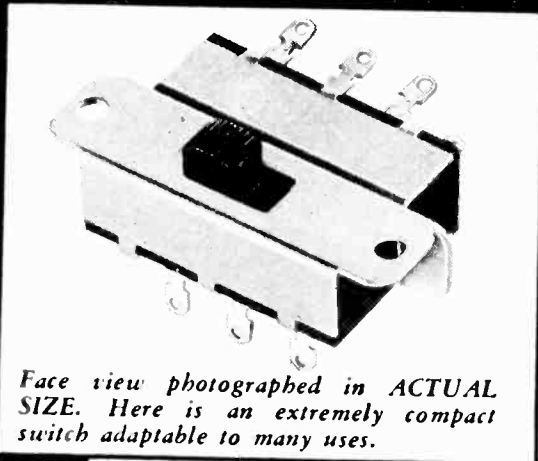

Face view photographed in ACTUAL SIZE. Here is an extremely compact switch adaptable to many uses.

Four pole, double throw switch, adaptable to all small circuits

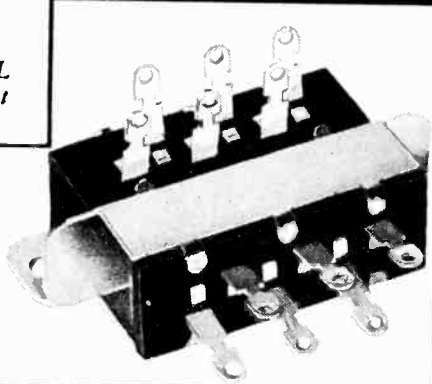

Side view shows terminals in two planes, making them more accessible in wiring the equipment.

THIS switch has the positive indent action associated with all STACKPOLE slide switches. It is fully approved by the Underwriters with a .5 Amp., 125 Volt rating and assures good low resistance contact. The SS-12 Slide Switch is mechanically rugged and has no delicate parts to get out of adjustment. All moving parts and contacts are fully enclosed eliminating chance for damage or accumulation of dust. Its unique compactness is important in small space installation and its design makes possible important time saving in assembly operations. Write today for samples and prices.

National Defense Development

The Stackpole Carbon Co. has the necessary personnel and facilities to develop special ideas and designs for Defense work involving FIXED OR VARIABLE RESISTORS, POWDERED IRON CORES or SWITCHES. Our experience in design and production of various types of small units places us in an ideal position in this field. We invite inquiries.



STACKPOLE CARBON CO.

ST. MARYS, PENNA. U. S. A.

Tube Types Previously Announced

Type 1B5/25S

DOUBLE diode, triode amplifier, filament type, ST-12 glass envelope, seated height $3\frac{1}{8}$ inches (max), 6-pin base.

$E_f = 2.0$ v
 $I_f = 0.06$ amp
 $E_b = 135$ v (max)
 $E_c = -3$ v
 $I_b = 0.8$ ma
 $\mu = 20$
 $r_p = 35000$ ohms
 $\theta_m = 575$ μ mhos
 Basing 6M-0-5

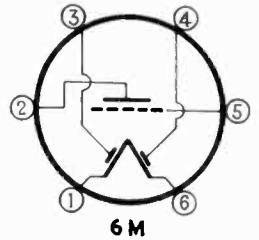

Type 2A3

POWER amplifier triode, filament type, ST-16 glass envelope, seated height $4\frac{3}{8}$ inches (max), 4-pin base.

$E_f = 2.5$ v
 $I_f = 2.5$ amps
 $E_b = 250$ v
 $E_c = -45$ v
 $I_b = 60$ ma
 $R_i = 2500$ ohms
 $P_o = 3.5$ watts
 Basing 4D-0-0

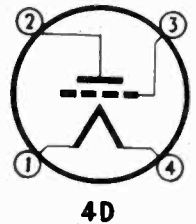

Type 2B6

DIRECT coupled triode power amplifier, heater type, ST-12 glass envelope, seated height $3\frac{1}{2}$ inches (max) 7-pin base.

$E_A = 2.5$ v
 $I_A = 2.25$ amps
 E_b (input) = 250 v
 E_b (output) = 250 v
 E_c (input) = -24 v
 E_c (output) = +2.5 v
 I_b (input) = 4.0 ma
 I_b (output) = 40 ma
 $R_i = 5000$ ohms
 $P_o = 4.0$ watts
 Basing 7J-0-0

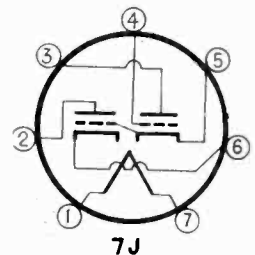



Type 6F7

Low-MU triode, r-f pentode, remote cutoff, heater type, ST-12 glass envelope, seated height $3\frac{3}{8}$ inches, 7-pin base.

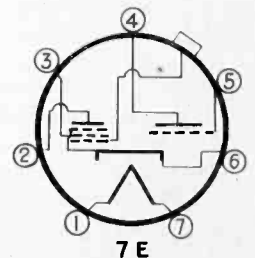
$E_A = 6.3$ v
 $I_A = 0.3$ amp
TRIODE SECTION
 $E_b = 100$ v
 $E_c = -3.0$ v
 $I_b = 3.5$ ma
 $\mu = 8.0$
 $\theta_m = 500$ micromhos
PENTODE SECTION
 $E_b = 250$ v
 $E_{c2} = 100$ v
 $E_c = -3$ v
 $I_b = 6.5$ ma
 $I_{c2} = 1.5$ ma
 $r_p = 850,000$ ohms
 $\theta_m = 1100$ micromhos
 Basing 7E-0-6

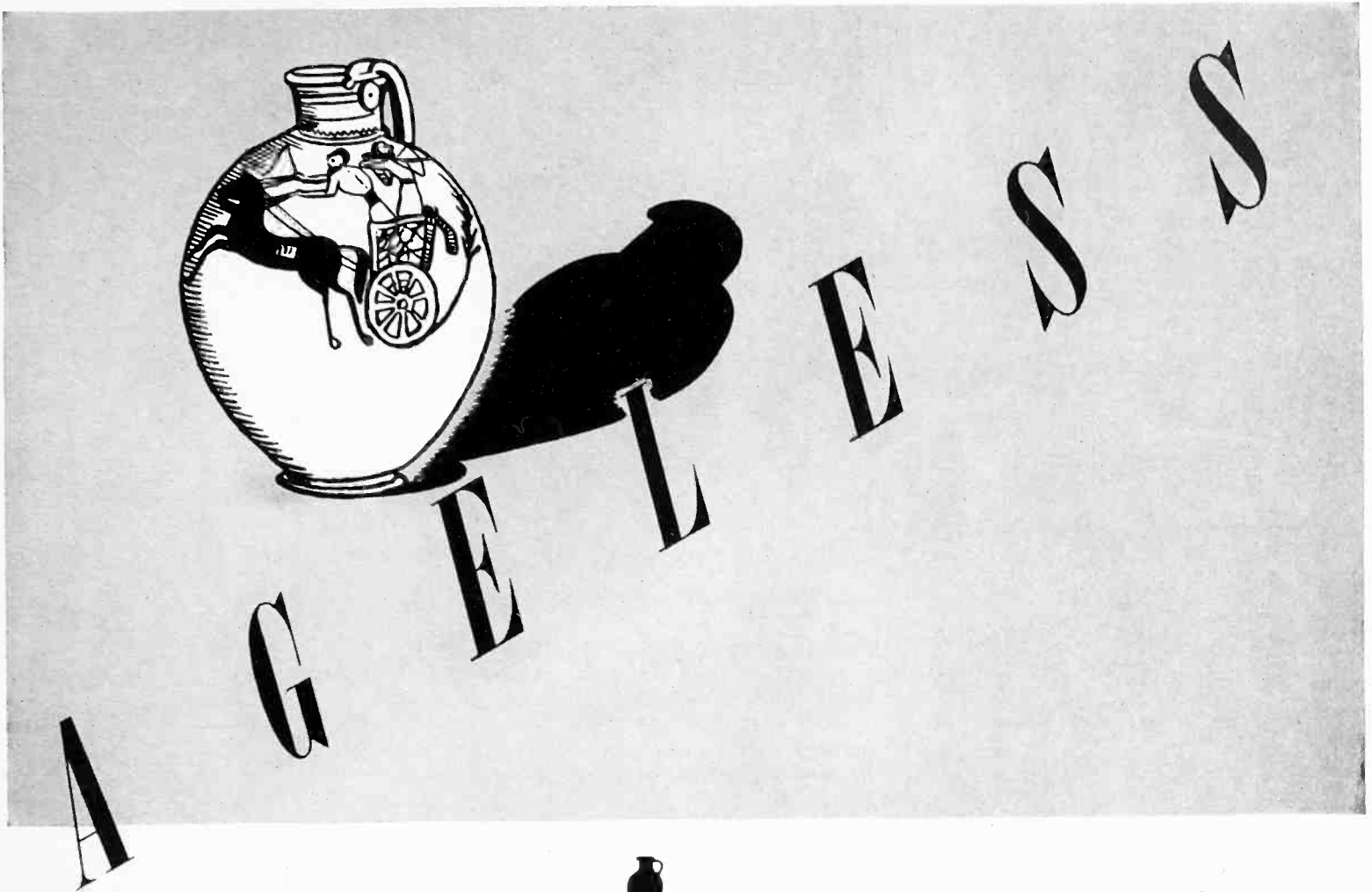



 From the later Neolithic age . . . through the Egyptian . . . and then the Greek . . . to say nothing of the Chinese Dynasties, ceramics have played an important part in reading the culture of those ages.

For ceramics are ageless . . . they have withstood the ravages of centuries.

In radio and various electronic uses ceramics play an important part . . . and CENTRALAB has taken full advantage of the inherent characteristics of ceramic materials . . . mechanical strength . . . high dielectrical qualities . . . humidity proof . . . unaffected by temperature changes.

That is why CENTRALAB Ceramic Capacitors meet the most rigid requirements of the industry.

CENTRALAB—Division of Globe Union Inc., Milwaukee, Wis.

FIXED CAPACITORS
TRIMMER CAPACITORS
FIXED RESISTORS

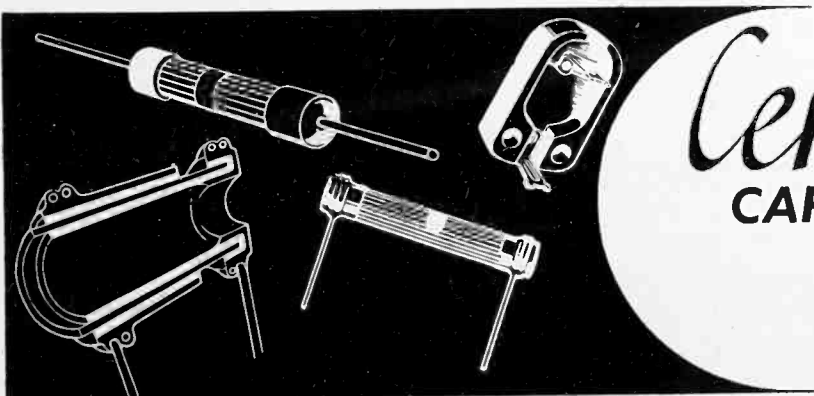

Ceramic

CAPACITORS and RESISTORS by

CENTRALAB

To pick up all remotes . . .

arm one brave
with 22D !

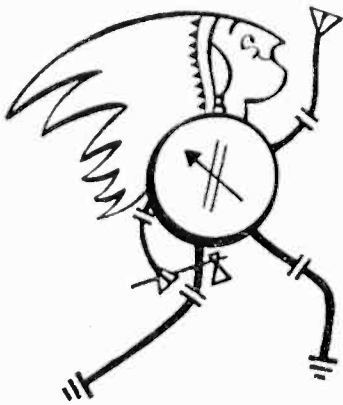

. . . says Chief Engineer

Now "22 tribe" has heir worthy of name. Western Electric 22D Portable Speech Input Equipment is true full-blood...follows tribe tradition of rugged construction, deluxe appearance, high fidelity. Has four mike mixers and master gain control.

One brave handles—like swiping candy from papoose!

Get details. Quick! Send smoke signal to Graybar Electric Co., Graybar Bldg., New York, N. Y

Western Electric

THE ANSWER

to your resistor problem may be found in these characteristics of

GLOBAR BRAND CERAMIC RESISTORS

REG. U. S. PAT. OFF.

1. Non-Inductive
2. Electrically stable
3. Mechanically strong

• These three characteristics are important in a great many applications. Perhaps they may lead to a solution of your own resistor problem. Our engineering department will gladly help you if you write and outline your requirements. Bulletin R contains technical information on "Globar" type A, B and CX ceramic resistors. Will be sent free on request.

**GLOBAR DIVISION
THE CARBORUNDUM COMPANY, NIAGARA FALLS, N. Y.**

REG. U. S. PAT. OFF.

Carborundum and Globar are registered trade-marks of The Carborundum Company

Globar CERAMIC RESISTORS

BRAND

Type 00A

DETECTOR triode, filament type, ST-14 glass envelope, seated height $4\frac{1}{8}$ inches (max), 4-pin base.

$E_f = 5.0$ v
 $I_f = 0.25$ amp
 $E_b = 45$ v (max)
 $E_c = 0$ v
 $I_b = 1.5$ ma
 $\mu = 20$
 $g_m = 666$
Basing 4D-0-0

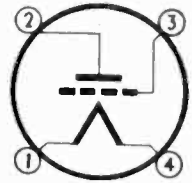

4D

Type 01-A

DETECTOR, amplifier triode, filament type, ST-14 glass envelope, seated height $4\frac{1}{8}$ inches (max), 4-pin base.

$E_f = 5.0$ v
 $I_f = 0.25$ amp
 $E_b = 135$ v (max)
 $E_c = -9$ v
 $I_b = 3.0$ ma
 $\mu = 8$
 $g_m = 800$
Basing 4D-0-0

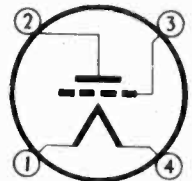

4D

Type 6E7

Similar to Type 6U7G

TRIPLE-GRID super-control amplifier, heater type, ST-12 glass envelope, seated height $3\frac{3}{8}$ inches (max), 7-pin base.

$E_A = 6.3$ v
 $I_A = 0.3$ amp
 $E_b = 250$ v
 $E_{c2} = 100$ v
 $E_c = -3$ v
 $I_b = 8.2$ ma
 $I_{c2} = 2.0$ ma
 $r_p = 0.8$ megohm
 $\mu_m = 1600$ μ mhos
Basing 7H-5-6

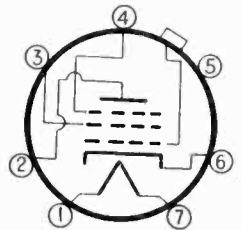

7H

8,000,000-VOLT GENERATOR

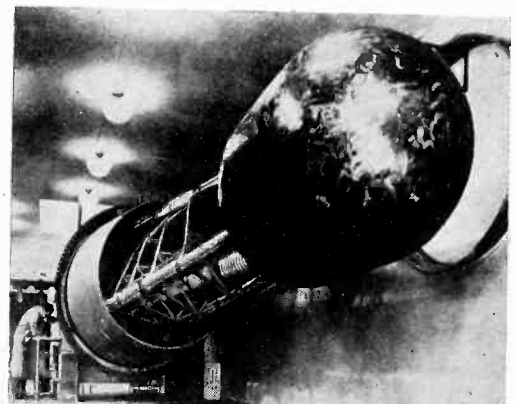

8,000,000 volts will be generated by this new 20-ton machine recently completed at Notre Dame University for experimentation in the disintegration of nuclei by high speed electrons. The device will also be used for the production of radioactive metals

Type 6C7

TWIN diode triode, heater type, ST-12 glass envelope, seated height $3\frac{1}{2}$ inches (max), 7-pin octal base.

$E_b = 6.3$ v
 $I_b = 0.3$ amp
 $E_c = 250$ v
 $E_c = -9.0$ v
 $I_b = 5.5$ ma
 $\mu = 20$
 $g_m = 1250$ micromhos
 Basing 7G-3-6

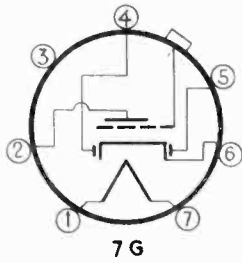

7G

Type 6D5

POWER output triode, heater type, metal envelope, 6-pin octal base.

$E_b = 6.3$ v
 $I_b = 0.7$ amp
 $E_c = 275$ v
 $E_c = -40$ v
 $I_b = 31$ ma
 $R_l = 7200$ ohms
 $P_o = 1.4$ watts
 Basing 6Q-1-0

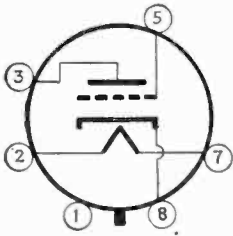

Type 6D7

Similar to Type 6C6

TRIPLE grid detector amplifier, heater type, ST-12 glass envelope, seated height, $4\frac{1}{8}$ inches (max), 7-pin base.

$E_b = 6.3$ v
 $I_b = 0.3$ amp
 $E_c = 250$ v
 $E_c = 100$ v
 $E_c = -3.0$ v
 $I_b = 2.0$ ma
 $I_c = 0.5$ ma
 $r_p = 1.5$ megohm
 $g_m = 1225$ μ mhos
 Spacing 7H-5-6

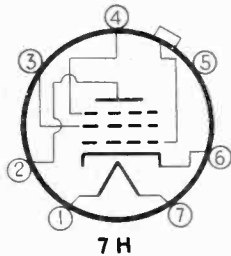

7H

Type 1A6

PENTAGRID converter, coated filament type, ST-12 glass envelope, maximum seated height $3\frac{3}{8}$ inches, 6-pin base.

$E_f = 2.0$ v
 $I_f = 0.060$ amp.
 $E_b = 180$ v
 $E_{c1,5} = 67.5$ v
 $E_{c2} = 180$ v (supply)
 $E_c = -3$ v
 $r_p = 50,000$ ohms
 $g_c = 300$ μ mhos
 $I_{cathode} = 6.2$ ma
 Basing 6L-0-0

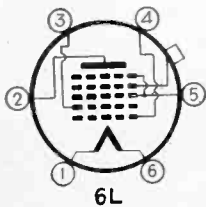

6L

Type 1C4

SUPERCONTROL r-f amplifier pentode, coated filament type, ST-12 glass envelope, maximum overall length, $4\frac{1}{8}$ inches, 4-pin base.

$E_f = 2.0$ v
 $I_f = 0.120$ amp
 $E_b = 180$ volts
 $E_{c2} = 67.5$ v
 $E_a = 0$ v
 $\mu = 1000$
 $r_p = 1.0$ megohm
 $g_m = 1000$ μ mhos
 $I_b = 2.5$ ma
 $I_{c2} = 0.9$ ma
 Basing 4M

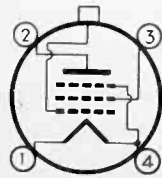

4M

It has ALWAYS been
TEXTOLITE
 with Guardian Electric

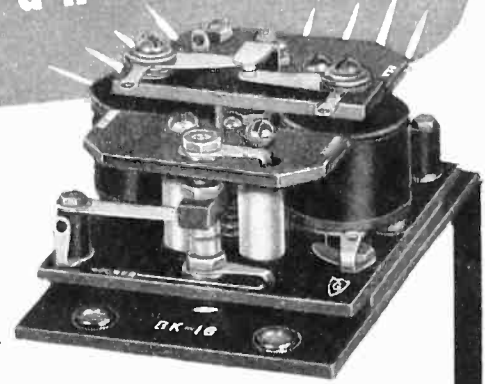

● There is obvious satisfaction in the knowledge that Guardian Electric Company engineers always have specified G-E Textolite alone for their single core relays.

Our pride in this vote of confidence, we believe, is justified. For the high standard of Guardian products guarantees the quality of its component parts and Textolite performs a vital function.

In the BK-16 relay, shown above, seven pieces of laminated Textolite are fabricated to rigid specifications. More than 30 holes were punched and drilled with a maximum tolerance of .002 inches between any two holes. All parts—to the number of 11,000 for this particular type—have a mirror finish on all sides and ends.

Guardian Electric's success with the use of Textolite is indicative of the results obtained by hundreds of users of this material for an almost unlimited variety of applications. It is the result of a thorough plastics operation which General Electric conducts in a sincere effort to produce the best possible quality at the greatest possible speed.

For details, write Section H-45, Plastics Department, General Electric Company, One Plastics Avenue, Pittsfield, Mass.

PD-174

PLASTICS DEPARTMENT
GENERAL ELECTRIC

AGASTAT

For Precision In Time Delay

UNAFFECTED BY DUST
DIRT OR TEMPERATURE

SET SCREW ADJUSTMENT
FOR DELAY INCREASE

FOR USE WITH EITHER
AC OR DC CURRENT

DIVERSITY OF TIMING
EFFECTS POSSIBLE

POSITIVE SNAP-ACTION
TYPE CONTACTS

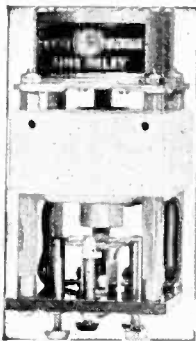

• This time delay unit is gaining popularity in industry for unfailing dependability. Its diversity of timing effect—

from a fraction of a second to several minutes and its adaptability to either AC or DC circuits make it particularly useful for delay control under severe conditions. Descriptive bulletin N-40, available on request; no obligation. Write for your copy!

**AMERICAN
GAS ACCUMULATOR
COMPANY**
ELECTRICAL DIVISION
ELIZABETH, NEW JERSEY

Type 6P7 (G)

Similar to Type 6F7
Low-MU triode, r-f pentode, remote cutoff, ST-12 glass envelope, seated height $3\frac{3}{8}$ inches, 7-pin base.

$E_h = 6.3$ v
 $I_h = 0.3$ amp
TRIODE SECTION
 $E_b = 100$ v
 $E_c = -3.0$ v
 $I_b = 3.5$ ma
 $\mu = 8.0$
 $\mu_m = 500$ micromhos
PENTODE SECTION
 $E_b = 250$ v
 $E_{c2} = -3$ v
 $I_b = 6.5$ ma
 $I_{c2} = 1.5$ ma
 $\mu_m = 1100$ micromhos
 $r_p = 850,000$ ohms
Basing 7U-0-8

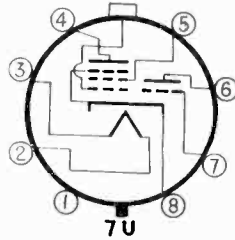

Type 6A4-LA

POWER amplifier pentode, filament type, ST-14 glass envelope, seated height $4\frac{1}{8}$ inches (max), 5-pin base.

$E_f = 6.3$ v
 $I_f = 0.3$ amp
 $E_b = 180$ v
 $E_{c2} = 180$ v
 $E_c = -12$ v
 $I_b = 22$ ma
 $I_c = 3.9$ ma
 $R_l = 8000$ ohms
 $P_o = 1.4$ watts
Basing 5B-0-0

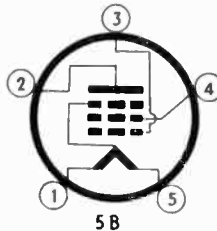

Type 1A6

PENTAGRID converter, filament type, ST-12 glass envelope, seated height $3\frac{3}{8}$ inches (max), 6-pin base.

$E_f = 2.0$ v
 $I_f = 0.06$ amp
 $E_b = 180$ v
 $E_{c3,5} = 67.5$ v
 $E_{c2} = 135$ v
 $E_{c4} = -3$ v
 $I_b = 1.3$ ma
 $I_{c3,5} = 2.4$ ma
 $I_{c2} = 2.3$ ma
 $\mu_c = 300$
Basing 6L-0-0

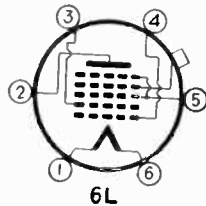

Type 2Z2/G84

Similar to Type 1-V
HALF-WAVE rectifier, filament type, ST-12 glass envelope, seated height $3\frac{1}{8}$ inches (max), 4-pin base.

$E_f = 2.0$ v
 $I_f = 1.5$ amp
CONDENSER INPUT
TO FILTER
 $E_{ac} = 325$ v (max)
 $I_{dc} = 45$ ma
Total effective plate supply impedance = 75 ohms
 $E_{drop}(I_{dc} = 90 \text{ ma}) = 20$ v
Basing 4B-0-0

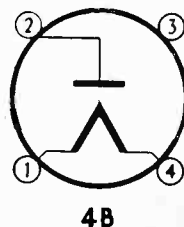

New Carter AIRCRAFT TYPE GENEMOTORS

• **TRIPLE OUTPUT!!**—Think what this means—3 separate outputs from a single Dynamotor! The new Carter Triple Output Dynamotor shown below, is winning wide acclaim in the Aircraft Industry because of its high efficiency, small size, and extra light weight.

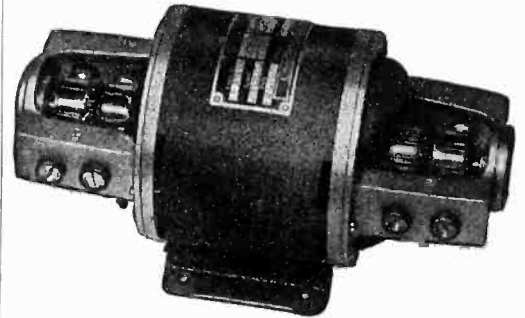

• Write today for descriptive literature on Carter Dynamotors—D.C. to A.C. Converters—Double and Triple Output Dynamotors—Magmotors—Special Motors—High Frequency Converters—and Permanent Magnet Dynamotors.

Carter Motor Co.
CHICAGO ILLINOIS

1606 Milwaukee Ave. Cable: Genemotor
Carter, a well known name in Radio since 1922

NEW TERMINALS With Wide Range Utility

No. 140 SERIES

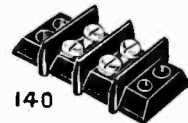

$\frac{3}{4}$ " wide and
 $13/32$ " high.
2 to 21 terminals.
5-40 x $3/16$ " screws.

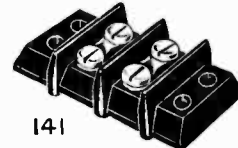

$1\frac{1}{4}$ " wide x $\frac{1}{2}$ " high.
2 to 20 terminals.
6-32 x $\frac{1}{4}$ " screws.

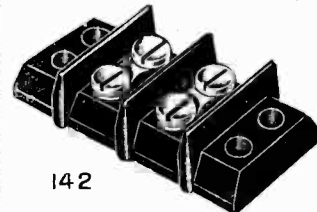

$1\frac{5}{16}$ " wide x $\frac{5}{8}$ " high.
2 to 17 terminals.
8-32 x $5/16$ " screws.

Made in three sizes as shown above. Barrier strips not only make a long leakage path, but prevent direct shorts from frayed wires at terminals. Molded bakelite insulation.

Terminals, Terminal Panels, Plugs, and Sockets made to your specifications.

Write for prices and samples.

HOWARD B. JONES
2300 WABANSIA AVENUE,
CHICAGO ILLINOIS



**THE RELIABLE NAME FOR
EVERY ANTENNA NEED**

AM

**L
I
N
G
O**

FM

To Meet Your Specifications —to Solve Your Problems

Don't take the selection of your antenna for granted! In the past few years new standards have been introduced that can save you valuable dollars and step up the efficiency of your station.

To be sure of the utmost in performance and the newest improvements in design investigate the Lingo Vertical Tubular Steel Radiator. Constructed of seamless copper-bearing steel tubing of uniform and narrow cross-section throughout, providing low base capacitance; high characteristic impedance; practically sinusoidal current distribution. Other exclusive features include:

- Moderate initial cost
- Exceptional high efficiency
- Low maintenance cost
- Unexcelled stability
- Five year insurance protection
- Single responsibility for constructing and erecting.

Our engineering staff will be pleased to supply you with technical details as they apply in your own particular case—without obligation, of course. In writing please give location, power and frequency of station.

**VERTICAL
TUBULAR STEEL
AND
TURNSTILE
RADIATORS**

The First and Only Antenna of its Kind in the Industry!

The first Lingo Turnstile Radiator was furnished even prior to the Lingo Turnstile installations at the birthplace of FM at W2XMN, Alpine, New Jersey.

The improved, patented design now available offers new features with exclusive advantages—

- Antenna radiates a horizontal polarized signal with uniform circular field pattern.
- Antennas are custom built, and factory adjusted to the operating frequency, making no field adjustments necessary.
- Improved, simplified method of feeding and coupling.
- Turnstile elements fed by coaxial lines, no open turnstile wires used.
- Available with 2, 4, 6, 8 or 10 layers of turnstile elements depending upon desired gain.

Quotations available now for stations up to 50 KW and include essential tubular steel mounting pole, turnstile elements, coupling equipment, transmission lines feeding the elements, etc. Climbing steps, lighting equipment and sleet melting units are also available as optional equipment. Write today for complete facts and please indicate your proposed frequency, power and location.

JOHN E. LINGO & SON, Inc. Dept. E-5 CAMDEN, N. J.

**IN RELAYS
SPRINGS ARE
IMPORTANT**

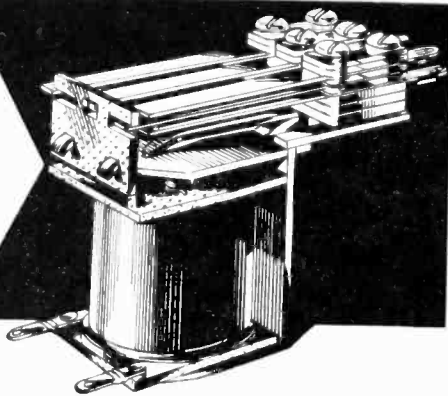

POSITIVE "MAKE"

THE contact springs on AUTECCO JR. relays provide proper pressure for a reliable contact of low resistance—pressure that breaks through, with a "wiping" action, any contact-surface film that may exist.

PERFECT "BREAK"

AUTECCO JR. relay springs have adequate separation. They are made to eliminate destructive arcs, or to extinguish them rapidly if they should form when the load to be broken is heavy.

Learn to depend upon AUTECCO JA. relays for outstanding performance.

Write today for detailed information, Address
American Automatic Electric Sales Company
1033 W. Van Buren Street Chicago, Illinois

AUTOMATIC ELECTRIC
RELAY MAKERS SINCE 1898

Streamline SHEET-METAL HOUSINGS

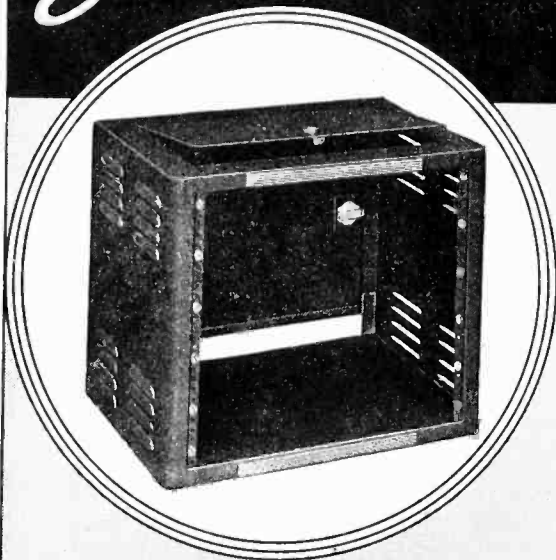

GENERAL CABINET RACKS

Featuring Beauty, Durability and Economy, these Streamline Cabinet Racks afford the BEST in enclosures for an endless variety of industrial electronic installations. The five cabinets made in this series accommodate 19" rack panels in heights from 8 $\frac{3}{4}$ " to 35".

Call on our Sheet Metal Department for estimates on your special requirements. We make custom-built cabinets, panels and punched chassis for many types of commercial applications.

MIDGET CONDENSERS

BUD precision-built midget condensers are made in many types and capacities for a variety of commercial requirements. They feature Alsimag 196 insulation, positive wiping rotor contact, electro-soldered rotor and stator assemblies, bright cadmium plated finish, and rugged mechanical construction. We will be pleased to furnish estimates on your requirements.

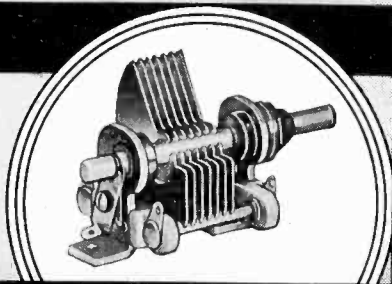

BUD RADIO, INC.

CLEVELAND, OHIO

Type 6C6

TRIPLE-GRID detector amplifier, heater type, ST-12 glass envelope, seated height 3 $\frac{3}{8}$ inches (max), 6-pin base.

$E_h = 6.3$ v
 $I_h = 0.3$ ma
 $E_b = 250$ v
 $E_{c2} = 100$ v
 $E_o = -3.0$ v
 $I_b = 2.0$ ma
 $I_{c2} = 0.5$ ma
 $r_p = 1+$ megohm
 $\theta_m = 1225$ micromhos
Basing 6F-0-5

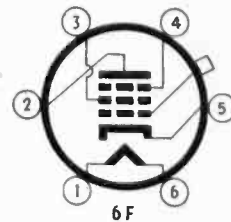

Type 80

FULL-WAVE high-vacuum rectifier, filament type, ST-14 glass envelope, seated height 4 $\frac{1}{8}$ inches, 4-pin base.

$E_f = 5.0$ v
 $I_f = 2.0$ amps
CONDENSER INPUT
TO FILTER
 E_{ac} (rms, per plate) =
350 v (max)
 $I_{dc} = 125$ ma
Total effective plate supply impedance per plate = 10 ohms (min)
CHOKE INPUT TO FILTER
 E_{ac} (rms, per plate) =
500 v (max)
 $I_{dc} = 125$ ma
Minimum value of input choke = 5 h
 E_{drop} ($I_{dc} = 125$ ma per plate) = 60 v
Basing 4C-0-0

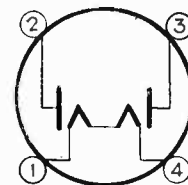

SCHOOL IN BED



Recently fifteen Iowa school districts have been equipped with complete two-way intercommunication systems enabling students convalescing from illness to have the benefits of classroom instruction. Shown here is the equipment located in a student's home; a similar although more elaborate instrument is located in the schoolroom. The State of Iowa provides the devices and the school system pays the telephone toll

RCA Cathode-Ray Oscillographs



The Instantaneous Curve-Tracing Instruments

The Oscillograph has become indispensable in so many applications and to so many fields of science and industry, that it would be nearly impossible to name one and say . . . "there is no use for Oscillographs here".

Today, for instance, RCA Oscillographs are familiar and important instruments in connection with such widely diverse interests as acoustics and vibration studies . . . studies of magnetic phenomena . . . water leak tests . . . geological and geophysical investigations . . . manufacturing operation tests . . . ignition timing and adjustment . . . medical and biological research . . . engine pressure indications . . . power plant maintenance . . . aeronautical engine synchronization . . . and a host of others, including well-known applications in communications, radio, television operation and servicing.

Don't overlook the help of these instantaneous curve-tracing instruments in solving your problems. There's an RCA portable Oscillograph to cover every application that could be desired of a portable unit. They so well represent the most advanced design and function that they have become the recognized standard of quality.

No. 155 — An inexpensive 3" Cathode-Ray Oscillograph is ideal for the vast majority of service applications. Provides large, clear images with simplified front-panel controls. Net Price, \$63.95

No. 160-B — 5" General-Purpose Oscillograph will perform all the functions of other RCA Oscillographs (except the Television model), and

may also be used for engine-pressure measurements and similar applications . . . Net Price, \$130.00

No. 158 — 5" Television Oscillograph is a highly specialized instrument, designed, not only for service work in accordance with present Television receiver development, but in anticipation of future television progress . . . Net Price, \$147.50

ASK FOR RCA CATALOG No. 105 — Describes RCA Oscillographs and other Test Equipment for a wide variety of industrial needs.

Typical Oscillograph Patterns

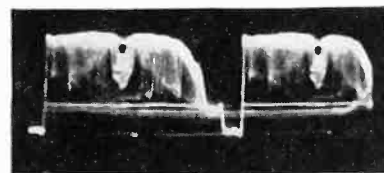

2 cycles of a 13,230 cycle per second Television video wave showing blanking and synchronizing impulse, and the picture-forming video waves.

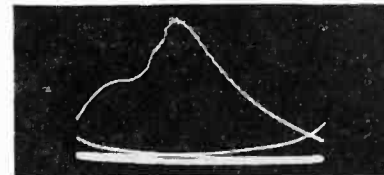

Typical Diesel engine pressure pattern showing pressure variation during compression and expansion strokes.

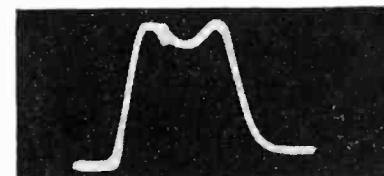

Response characteristic of a coupled resonant circuit showing frequency marker indication.



Test Equipment

RCA MANUFACTURING CO., Inc., Camden, N. J. • A Service of the Radio Corporation of America
In Canada: RCA Victor Company, Ltd., Montreal



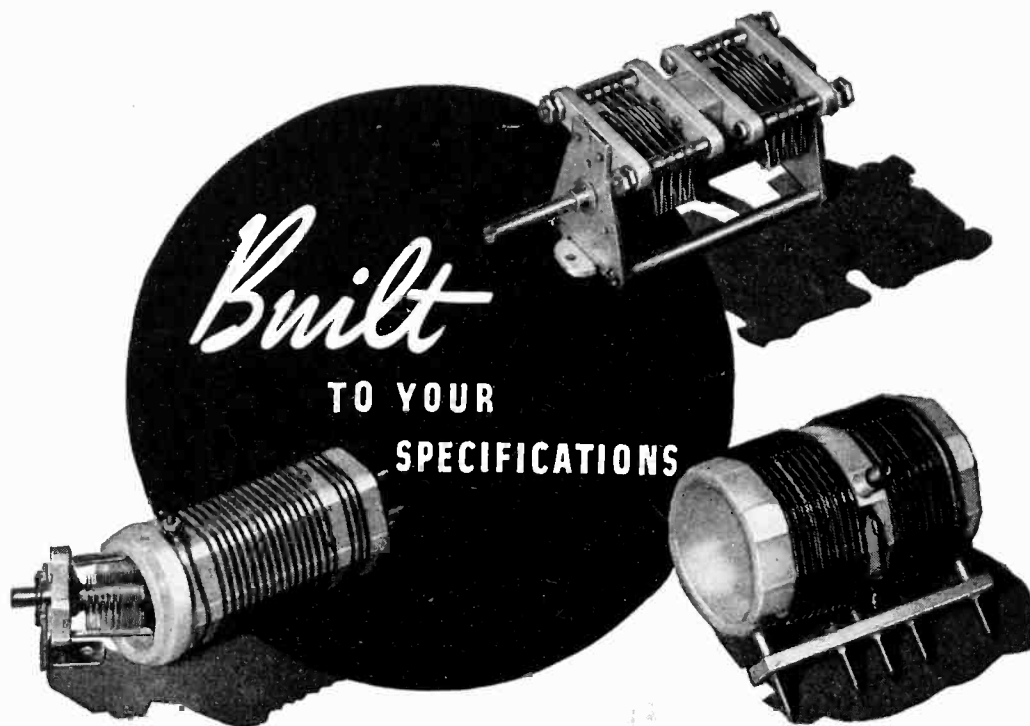

Johnson Inductors and Condensers are not stock items but are designed for your particular application. Standard with Broadcast stations for years they have assumed even greater importance in connection with phasing equipment and antenna coupling units.

Write us your problems today—Johnson Engineers know the answers.

Catalog 301 D Free



He's Learning That

WIRE-WOUND RESISTORS do a better job than the composition types.

Wire-Wound Resistors by Instrument Resistors, Inc. do not vary. Terminals can be mounted at any angle, and tolerances are closer.

Type WL shown here can be had for as little as 6 cents each. Delivery when you want them.

DETAILED INFORMATION UPON REQUEST.



Instrument Resistors, Inc. LITTLE FALLS, N. J.



PERMANENT MAGNETS

ALL SHAPES — ALL SIZES
FOR ALL PURPOSES

Stamped, Formed, and Cast; Chrome, Tungsten Cobalt and **ALNICO**** (cast or sintered) under G. E. license.

THOMAS & SKINNER

STEEL PRODUCTS COMPANY
1116 E. 23rd STREET INDIANAPOLIS, INDIANA

Laminations for Radio Transformers — Tools
Dies — Heat Treating — Stampings

40 YEARS EXPERIENCE

New Books

Television Broadcasting

BY LENOX R. LOHR, formerly president, National Broadcasting Co. McGraw-Hill Book Co., New York, 1940. 274 pages, 88 illustrations. Price, \$3.00.

THIS BOOK IS A DISCUSSION of television broadcasting to give the reader an overall understanding of its problems. The economic and legal aspects of the industry as well the technical and historical aspects are discussed in an easily understood manner. To the person who desires a broad acquaintance with the subject this book is an excellent source of information.

The book opens with a discussion of the broad influence of television on society, both as an entertainment medium and as a means of seeing news events as they happen with the greatly increased suspense over newsreels and newspapers. The potentialities of television for advertising and its power to actually demonstrate the product offered for sale is discussed. An example of what can be done is the dramatization of the use of a certain brand of pancake flour. Presented on the screen of the home receiver are pictures of pancakes cooking on the griddle and then being eaten by a group of children. This is a more powerful advertisement than any words could be.

A large part of the book is necessarily devoted to description of the methods of television and production of various types of programs, or the technical side of the problem. Anyone reading this portion of the book cannot help understanding the magnitude of the problems involved in the establishment and operation of a television broadcasting station.

Important legal problems rest upon the premise that television, in its operation, uses something which is a part of the public domain, that is, the radio spectrum, of which there is a very limited supply. Television must, therefore, justify its use of valuable space in the radio spectrum. Other important problems have to do with acquisition of rights to use copyrighted material, the activities of labor organizations, relations with advertisers, many of which are parallel to problems in sound broadcasting. The book closes with a summary of the regular service of the first eight months of operation and an appendix containing a typical television script with the attendant production directions.—c.w.

Dependability for Today

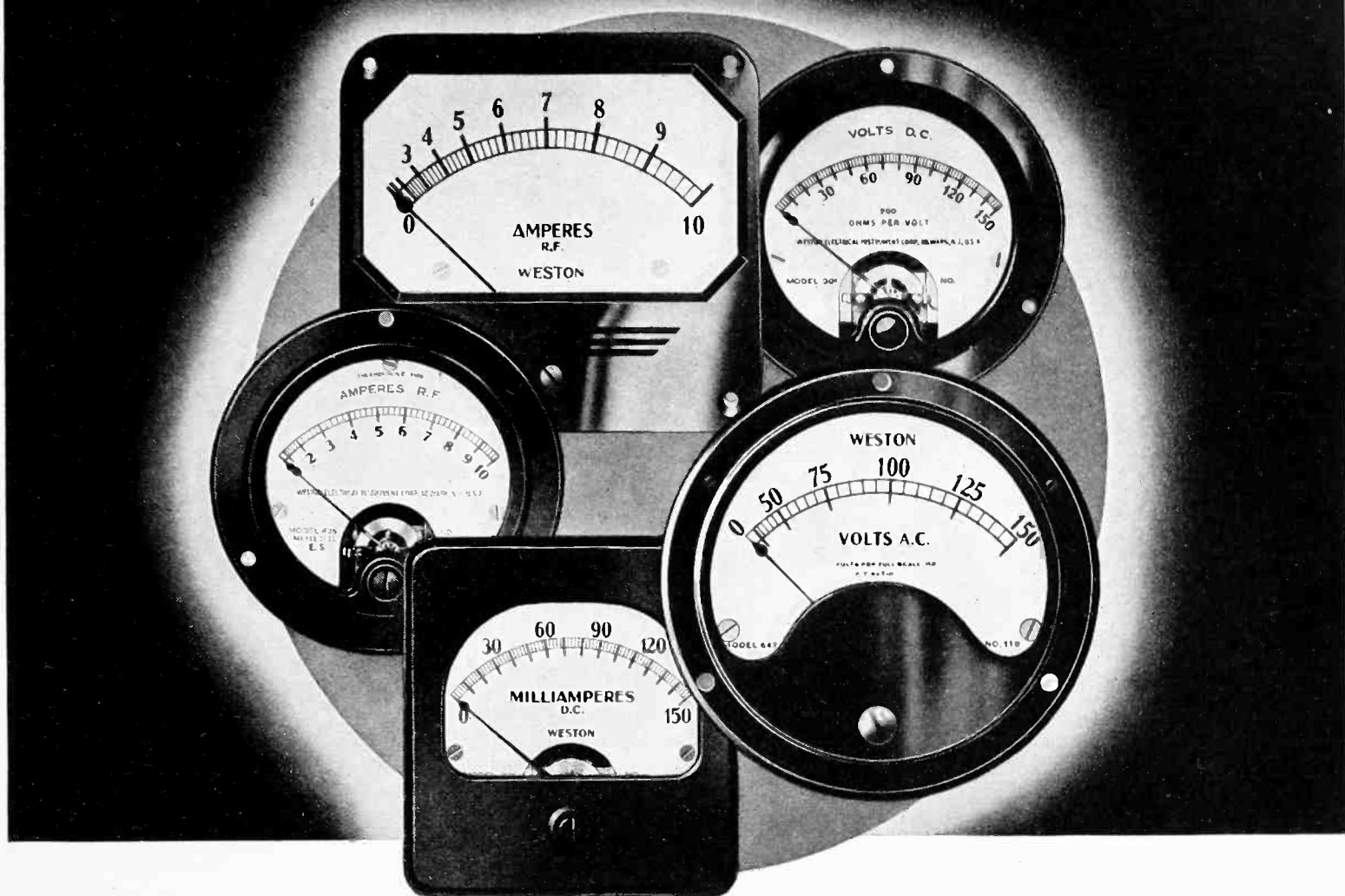

WISE INVESTMENTS FOR TOMORROW!

Mounted on the panels or controls of the machines you build, WESTON Instruments offer *more* than an extra increment of sales value for today . . . *more* than reliable protection for your machines during the active days just ahead. Their *long-term dependability* will stand you in good stead *after* the defense period has passed . . . when machine performance records will all be available and when *proved performance* becomes a critical buying factor once more. Weston Electrical Instrument Corp., 618 Frelinghuysen Ave., Newark, New Jersey.

Laboratory Standards . . . Precision DC and AC Portables . . . Instrument Transformers . . . Sensitive Relays . . . DC, AC, and Thermo Switchboard and Panel Instruments.

WESTON

Specialized Test Equipment . . . Light Measurement and Control Devices . . . Exposure Meters . . . Aircraft Instruments . . . Electric Tachometers . . . Dial Thermometers.

FOR OVER 53 YEARS LEADERS IN ELECTRICAL MEASURING INSTRUMENTS

This is
WHY

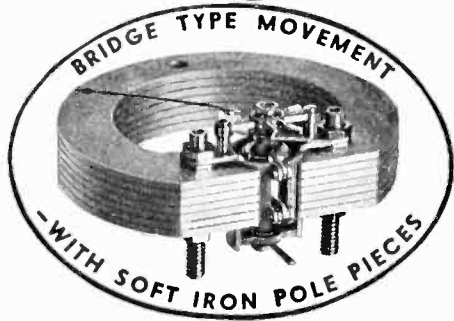

SIMPSON INSTRUMENTS MEET TODAY'S DEMANDS

THE superiority of Simpson Instruments—the ability to stand up under the drive of today's increased production loads—comes from a fundamental betterment, the Simpson movement shown above. It's the same type of movement as is used on precision laboratory instruments. It offers the fullest possible measure of accuracy, plus the stamina to maintain that accuracy—whether used for production testing or as part of your own products.

Just as this basic superiority makes Simpson Instruments outstanding in performance, Simpson prices make them outstanding in value too. Because Simpson has standardized on this movement throughout its entire line of panel instruments and testing equipment, this better design, finer craftsmanship, costs you no more than you'd pay for just-ordinary instruments.

Write for complete literature.

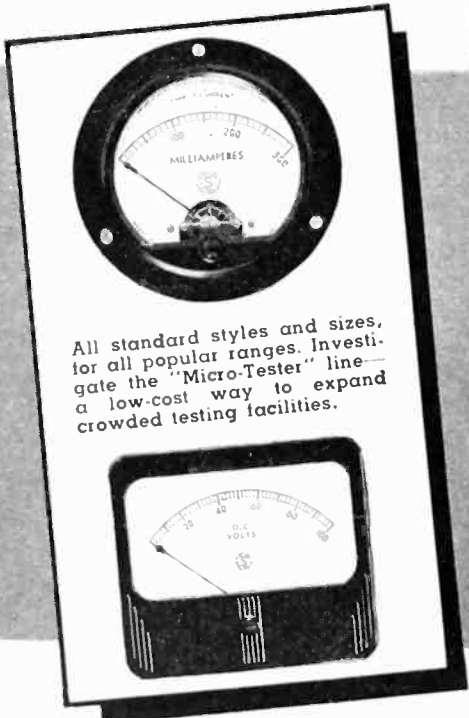

SIMPSON ELECTRIC CO.
5212 Kinzie St., Chicago, Ill.

Simpson
INSTRUMENTS THAT STAY ACCURATE

Priorities

(Continued from page 22)

great deal of work for the future. But whether this work will leave room for ordinary commercial production of consumer goods is another question. The manufacturers can get needed stocks for defense orders very readily, and the priorities assigned to such orders may be extended to contractors and subcontractors. But such is not the case for non-defense production. The industry argues, however, that it must keep its forces intact, and regular production going, so that the defense orders can be carried along efficiently with the other business. The argument is that if normal production is curtailed or suspended, it may be difficult to turn out defense equipment, especially since a very large proportion of the defense orders are concentrated in the larger plants.

The prospective rise in prices is expected to have its effect primarily in the lower priced brackets. It will surprise no one if the \$9.95 receiver is forced off the market temporarily, and possibly permanently. The gross margin available to the manufacturer on the cheaper sets is very much narrower than on the higher priced items, hence any increase in component prices, or labor costs, will quickly force an upward revision of the price of such sets. Moreover, many of those planning fall production feel that it will not be sufficient merely to increase the price of the \$9.95 set, producing substantially the same chassis and mounting it in the same cabinet. It appears to be much sounder merchandising to offer a better set, at a proportionately greater price, and to incorporate in the set some definite selling point, in the chassis or cabinet or both, which will justify the price. It is thus the supposition, if not the fond hope, of many manufacturers that an improvement in the price level, and quality level, will be forced on the industry. Whether the cure will be permanent remains to be seen.

Faced with the situation just outlined, the Radio Manufacturers Association has set up a priorities committee, consisting of Paul V. Galvin, of the Galvin Manufacturing Com-

EXPERIMENT WITH THIS MERCURY MIDGET SWITCH!

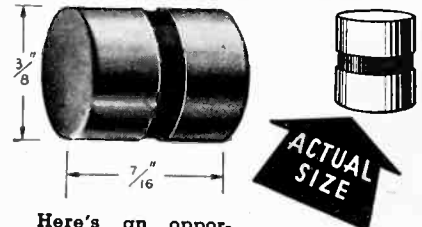

Here's an opportunity for you to play with—a chance to do some experimenting and whip those "switch" problems you've been up against. The Littelfuse Mercury Midget is designed for low voltage circuits up to 25 volts A.C. or D.C. and currents up to 10 amps at 6 volts and 5 amps at 25 volts. No friction; no wear; no maintenance problem. Positive make-and-break operation eliminates "flickering".

Two Sizes: 7/16" long and 3/8" in diameter and 7/16"x1/4" in diameter. List price 15¢ each.

Some present applications are: thermostat circuits; auto glove and trunk compartments; radio door lights; indicator circuits, etc. What application will your experimenting suggest? Write for full information.

LITTELFUSE, INC.
4755 N. Ravenswood Ave., Chicago, Ill.

Dependable ONAN ELECTRIC PLANTS

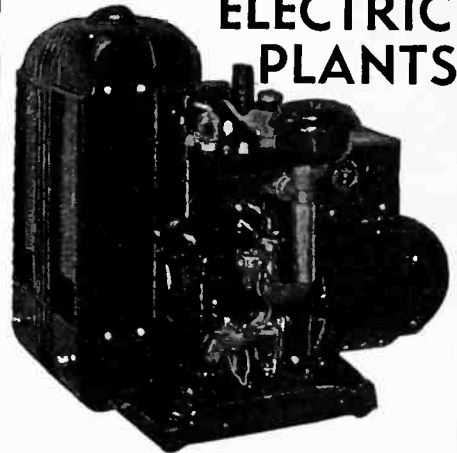

COMPLETE — READY TO OPERATE ON THE JOB during Emergencies when Power Lines fail.

Operate anything Electrical — LIGHTS, RADIO TRANSMITTERS and RECEIVERS, Motors, X-Ray, All Appliances. Used by City, State and Federal Departments, Police and Fire Departments, in News Pickup and Advertising Cars, Public Buildings.

NEW STYLES — MANY NEW MODELS — OVER 40 STOCK MODELS 350 to 50,000 Watts. Any Voltage — any Frequency — Completely Radio Shielded. Highest Quality — Compact — Heavy Duty.

WRITE for Complete Details

D. W. ONAN & SONS
331 Royalston Ave. Minneapolis, Minn.

»» We Punch, Machine and Print, Insulating Parts for Electrical Devices

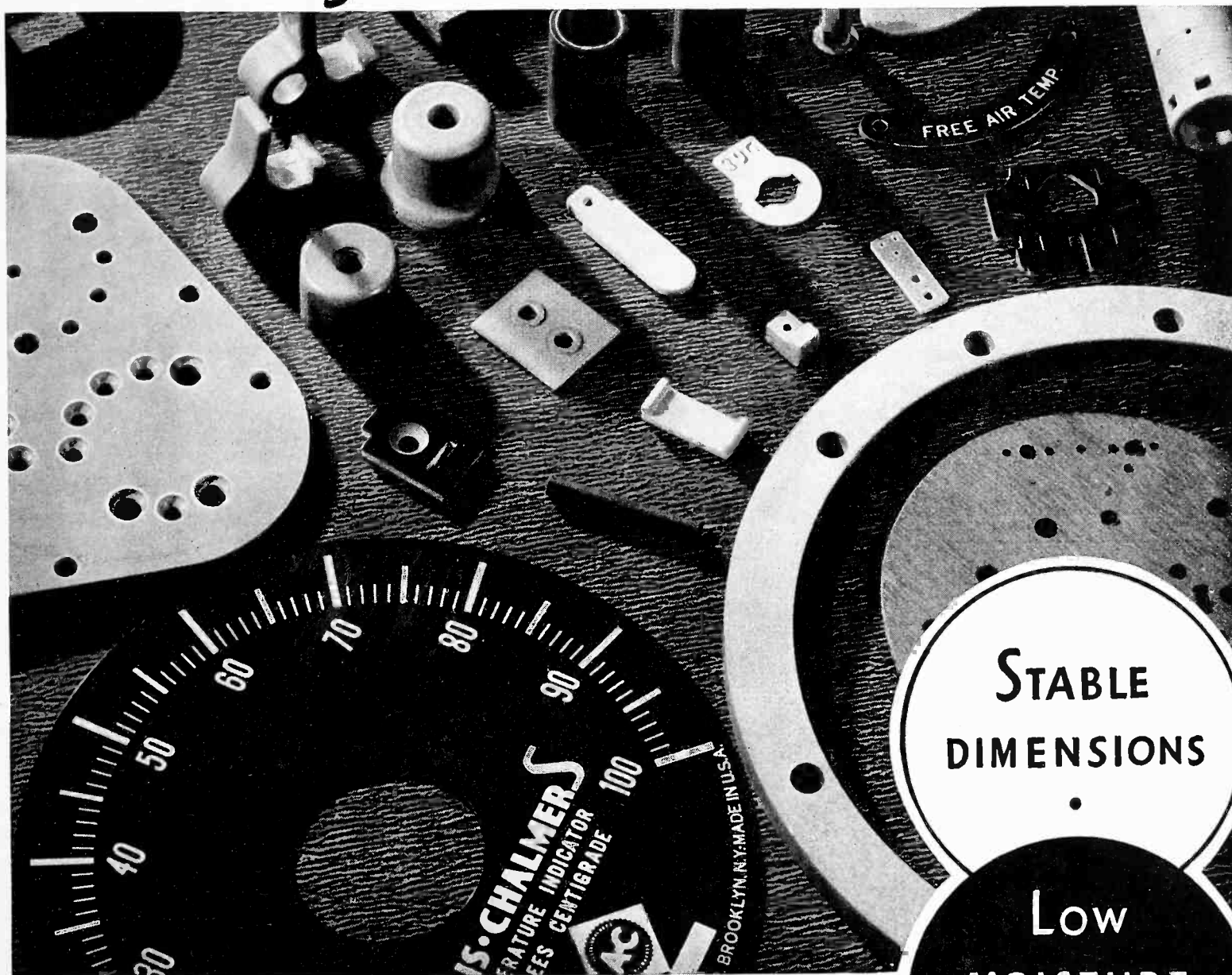

STABLE
DIMENSIONS

Low
MOISTURE
ABSORPTION

Low
POWER FACTOR
AND
HYSTERESIS
LOSSES

IN addition to one of the largest volumes of production in the industry for laminated sheets, tubes and rods, Formica maintains a very complete and well equipped fabricating department for all types of machining on laminated parts. It also prints, stamps and engraves sheet and tubing by a number of processes. For 28 years the Formica organization has been specialized on just one product — laminated phenolic material. It has maintained a large and well equipped laboratory whose business it has been to learn as much as possible about that one product. The result has been high and uniform quality, and the development of special grades emphasizing special qualities to meet particular requirements. You can get what you want in laminated insulation from Formica. Send your blue prints for quotations.

FORMICA

The Formica Insulation Co.
4661 Spring Grove Ave.
Cincinnati, Ohio

I N S U L A T I N G P A R T S

SILVER • PLATINUM PALLADIUM

HARD ALLOYS FOR CONTACTS

PRECIOUS METAL IN ALL FORMS AND ALLOYS FOR
RADIO, ELECTRICAL, AND CONTROL EQUIPMENT

Foil	Strip	Fine Wire
Discs	Gauze	Wollaston Wire
Contacts	Tubing	Thermocouple Wire

SILVER BRAZING ALLOYS — SOLDERS — FLUXES

★

The American Platinum Works

N. J. R. R. AVE. AT OLIVER ST.

Newark  New Jersey

EST. 1876

WRITE DEPT. "L"

FOR INFORMATION

Bliley CRYSTAL UNITS

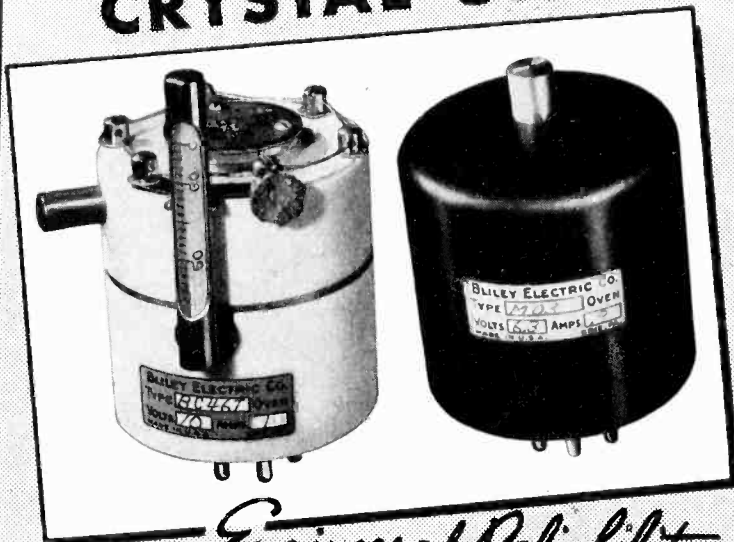

*Engineered Reliability
— Guaranteed Accuracy . . .*

BLILEY precision-made Crystal Units
are supplied for all frequencies
from 20Kc. to 30Mc. Catalog G-12
contains complete information.

BLILEY ELECTRIC COMPANY

UNION STATION BUILDING

ERIE, PA.

pany, Fred D. Williams of Philco, F. R. Deakins of R.C.A. Manufacturing Company, Ray F. Sparrow of P. R. Mallory and Co., and A. Bloom of the General Instrument Company. A meeting of this committee was scheduled for April 20th with Dr. E. M. Hopkins, of the Metals and Minerals section of the Priorities Division. The purpose of the meeting was a general discussion of the means whereby the requirements of the radio industry for restricted materials might be reduced, to determine if possible whether materials like copper and iron, now considered as substitutes, may eventually fall into the restricted class, and in general to discuss the position of the radio industry in the priorities outlook. The immediate future of the radio manufacturing industry, so far as the production of receivers for home use is concerned, depends on the point of view developed from such discussions. It seems unlikely that any severe hardship will be imposed on the industry, insofar as it is an important part of the defense production system. But that prices will rise, and that the customer may find new compromises in the sets offered this fall, may be taken as certain.

In 1940, the industry produced slightly more than 10,000,000 sets. This year, early rosy predictions have been revised radically downward. Even if the industry gets the breaks on all pending questions, it seems unlikely that more than 5,000,000 sets can be produced this year. This means a sharp reduction in demand for components, and the suppliers can hardly expect to make up the difference selling to manufacturers for defense radio production, which consists primarily of relatively small-volume orders of high-priced units. Sub-contracting work will be available to many of these concerns, which will help to stabilize the situation. But careful planning for the immediate future is very much in order.

Higher prices, lower volume, questionable margins are the order of the day. But the industry may be encouraged by the fact that its members are working together, with the government, in a way which indicates a rapid adjustment to the new conditions, which is in itself a vital contribution to the defense effort.—D.G.F.

THE ELECTRON ART

Generation of spurious signals by broadcast stations, a precision integrating sphere densitometer, line microphones, an ionization gauge, and telephone transmission circuits for radio programs are reviewed this month

Spurious Signals

AN EFFORT to obtain quantitative data on interference with radio transmissions which is commonly characterized by the generation of spurious signals by the transmission of radio stations on frequencies to which they are not assigned is described in "The Generation of Spurious Signals by Non-linearity of the Transmission Path," by Austin V. Eastman and Lawrence C. F. Horle in the October 1940 issue of the *Proceedings of the I.R.E.* After preliminary investigations in a number of cities, it was decided to continue the work in Seattle, Wash., because of the constancy and severity of the interference in that city. There are six broadcasting stations within the city of Seattle, all of them within relatively short distances of each other, and within short distances of the business and residential sections of the city.

A comparison of interference measurements obtained show that the only terms of importance results from the expansion and reduction of the second and third order terms of the power series. These are:

From the second order term

$$1/2 BE_1^2 \cos 2\omega_1 \quad (1)$$

$$BE_1E_2 \cos (\omega_1 \pm \omega_2) \quad (2)$$

and from the third order term

$$3/4 CE_1^2E_2 \cos (2\omega_1 \pm \omega_2) \quad (3)$$

$$3/2 CE_1E_2E_3 \cos (\omega_1 \pm \omega_2 \pm \omega_3) \quad (4)$$

The $E_1E_2E_3$ terms are the signal voltages of frequencies ω_1 , ω_2 and ω_3 , respectively, and B and C are the coefficients of the second and third order terms of the basic power series. Each of these terms comprises three component factors. These are: (a) The frequency factor included in the trigonometric term in each equation; (b) The field product which includes the voltage terms, raised to their appropriate powers and the numeric ($3/2 E_1 E_2 E_3$ in Eq. 4), and (c) The susceptibility factor which comprises the coefficient B or C .

Correlation of the data indicated a sharp line of demarcation between cases of interference and non-interference at a field product of about 0.001 (volts per meter)³. The data obtained are probably too meager to permit any generalization as to the value of the field product which must not be exceeded to avoid cross modula-

tion. Yet the evidence points strongly to the conclusion that there is such a value.

It is unfortunate that in the area under consideration the centers of population and areas of excessive field products largely coincide, because of the proximity of three most powerful stations to each other and to the residential area. It is suggested that one method for the avoidance of cross-modulation interference lies in the assignment of local stations to frequencies which differ one from the other by the same amount. Thus all spurious signals generated by cross modulation would lie on the frequency of some other local station and would presumably be masked. There is, of course, the possibility that this would constitute a disagreeable background interference, but it is felt that this may be the lesser of the two evils.

Precision Integrating-Sphere Densitometer

A PRECISION INTEGRATING-SPHERE densitometer which makes use of a phototube and amplifier circuit is described by J. G. Frayne and G. R. Crane in the August 1940, issue of the *Journal of the Society of Motion Picture Engineers*, and the November 1940, issue of *The Review of Scientific Instruments*. The articles in both magazines cover the same instrument with a little greater theoretical detail given in the first mentioned periodical. The instrument described was developed for the measurement of density of photographic sound tracks in the motion picture industry to eliminate differences occurring in previous densitometers due to both design factors and differences in individual operators. A schematic diagram of the integrating-sphere densitometer is shown in Fig. 1. It is well known that the illumination of the interior surface of the integrating sphere depends upon the intensity of light passing through the film at the aperture in the sphere. Precautions are taken, of course, to prevent illumination of the phototube surface either directly from the film or from the point directly opposite the opening of the sphere which might be brightly illuminated by direct light. By proper amplification of the phototube current and a suitable measuring instrument, the density of the film can easily be determined. A light chopper is placed in the

ELECTRIC SYNCHRONIZER



This synchronizer is used during firing practice of 50-calibre heavy machine guns by the 62nd Coast Artillery at Fort Totten, N. Y. The two men with the headsets receive information from the battery commander stationed some distance away, on matters of wind velocity and leads. This information is mechanically transmitted through adjustments on the panel and impulses are sent through the appropriate cables in the foreground which automatically adjust the sights of the gun

PINCOR PRODUCTS FOR AIRCRAFT SOUND and other POWER SUPPLY USES

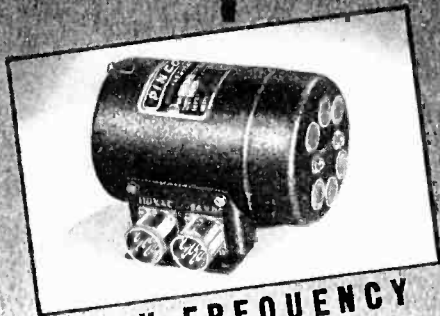

HIGH FREQUENCY CONVERTERS

Pincor High Frequency Converters are precision built for smooth, silent, dependable performance. 5 to 500 watts. 400 and 500 cycles. Special units designed to meet any output or requirements.



SMALL MOTORS—A. C. and D. C.

These small motors are particularly adapted for band switching, remote control, etc., for aircraft use or wherever a small light weight motor is required for unfailing service. 20 watts output. Others as required.



DYNAMOTORS

Pincor Dynamotors afford a dependable "B" power supply for aircraft, marine and broadcast service, mobile units, etc. Highest efficiency and regulation. 5 to 850 watts. Input 6 to 110 volts; output up to 1750 volts.

Write or Wire for Information

PIONEER GEN-E-MOTOR CORPORATION
CHICAGO, ILLINOIS

Export Address: 25 Warren St., N. Y., N. Y.

Cable: Simontrice, New York

light beam as shown in Fig. 1, to provide an alternating current of 600 or 720 cycles per second for a power supply of 50 or 60 cycles, respectively, so that the use of a d-c amplifier is unnecessary.

In order to measure effectively the range of density in sound photographic processes, it is necessary to read

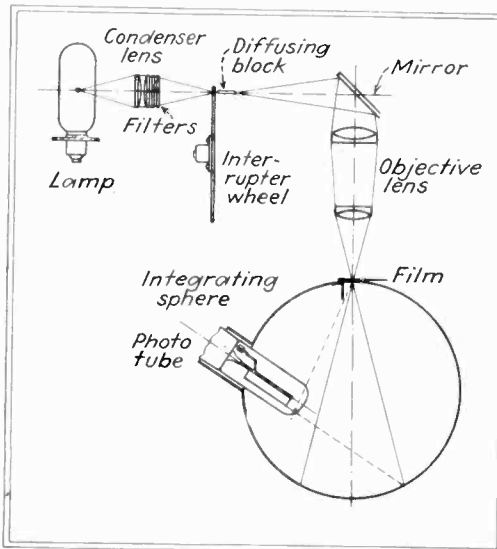

Fig. 1—Diagram of the integrating sphere densitometer

densities as high as 3.0. This means a range of 1000 to 1 or 60 db in input voltage of the amplifier. To cover this great range three ranges of 0 to 1.0, 1.0 to 2.0 and 2.0 to 3.0 are provided. The range switch is shown in the output circuit of the first amplifier tube in Fig. 2.

A high gain stable amplifier is required to increase the output of the phototube to a level suitable for measurement. Since density is funda-

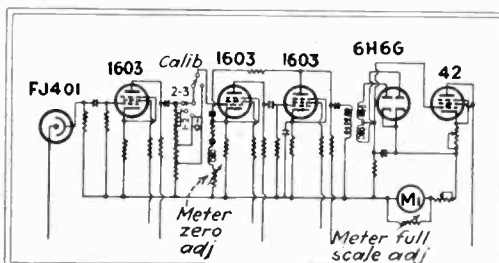

Fig. 2—Circuit diagram of the amplifier associated with the densitometer

mentally a logarithmic function any attempt to indicate density using linear elements will result in an uneven scale on the indicating meter with crowding of the scale at the higher density values. To facilitate observation of the scale, it is desirable either to make an amplifier with a logarithmic response or to provide a meter, the deflection of which will be a logarithmic function of the current supplied to the meter. A special meter was developed having a full scale of 20 milliamperes with logarithmic response. The damping of a meter of this type

is difficult to control because of the wide variation of flux density at different scale positions, but the meter period is sufficiently high that little inconvenience is caused by the underdamped condition which exists at the left hand or zero end of the meter scale.

Line Microphones

THE THEORY AND PRACTICE of line microphones are described in two articles which appear in the March 1941 issue of the *Journal of the Society of Motion Picture Engineers*.

The first one is by Harry F. Olson in which are described the characteristics of the simple line microphone and the

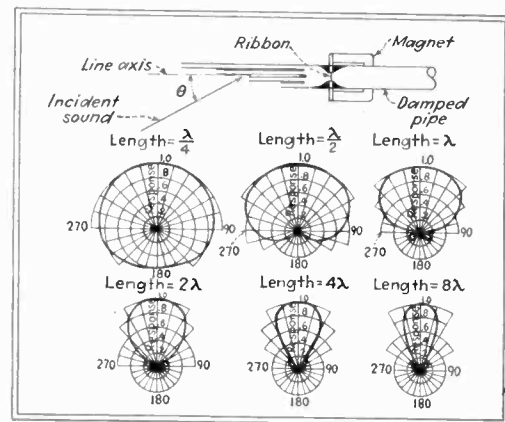

Fig. 1—Cross-section of the simple line microphone and its directional characteristics

line microphone with progressive delay. The line microphone is defined as a microphone consisting of a large number of small tubes with the open ends as pickup points equally spaced along a line and the other end connected by means of a junction to a transducer element for converting the sound vibrations which converge upon the junction into the corresponding electrical variations. In the micro-

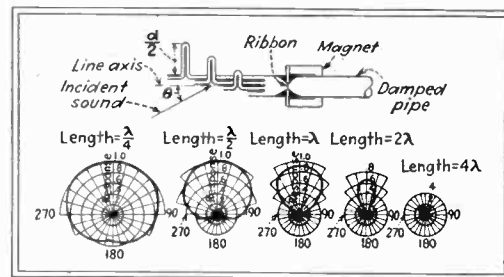

Fig. 2—Line microphone with delay and its directional characteristics

phone described in this article, the transducer is a ribbon element located in a magnetic field and terminated in an acoustic resistance. Under these conditions the output of the pipe may be added vectorially. The directional characteristics of the simple line microphone for various ratios of length of the line to the wavelength are shown

in Fig. 1. These characteristics are surfaces of revolution about the line as an axis.

The simple line type of microphone becomes quite long if high directivity is desired at the lower end of the audible spectrum. However, it is possible by introducing into the pipes a delay which becomes progressively greater with the length of individual

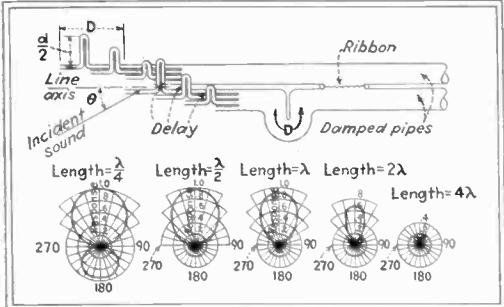
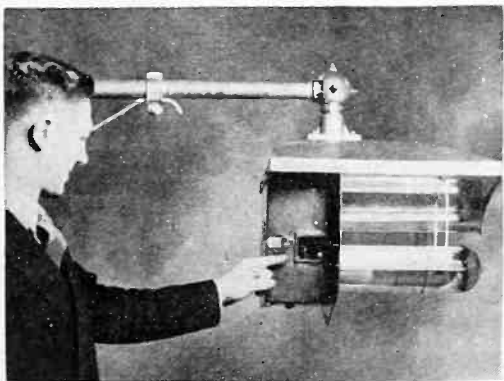

Fig. 3—Line microphone with delay and pressure gradient element

pipes, to effect an increase in directivity. The method of obtaining the delay is shown in Fig. 2. Also shown in Fig. 2 are the directional characteristics of the microphone with the progressive delay. The use of a pressure gradient element in the two-line microphone with progressive delay is also discussed. This is shown in Fig. 3. By the use of these expedients the same degree of directivity may be obtained with a line of one-quarter the length necessary for a simple line.

In the other article by L. J. Anderson, a line type of microphone especially designed for speech pick-up is described. In a simple line microphone about 6 feet long, with maximum response along the axis, the angle at 150 cycles per second will be about 160

• • •
AGAIN, THE "ELECTRIC EYE"



Newest development of G.E.'s sodium vapor lamp is the unit shown above equipped with a phototube which turns the light on and off automatically when needed. A time delay switch prevents faulty operation which might be caused by lightning flashes or headlights of automobiles or trains shining on the phototube to which the engineer is pointing

CLARE Type "F"

Micro-switch • Snap-action Contact

RELAY

Operates on a few milliamperes—contacts carry 10 amperes 110 V. a.c. Particularly adapted for machine control, motor and lamp loads, photo electric and similar applications.

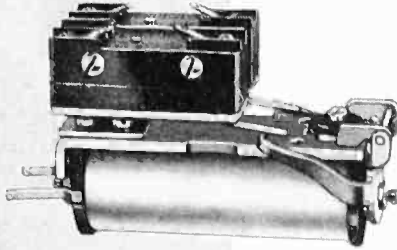

C. P. CLARE & CO.
LAWRENCE & LAMON AVES. - - CHICAGO
15 EAST 26TH STREET, NEW YORK CITY

CLARE Type "FM"

Snap-action Contact

RELAY

For slightly heavier loads—contacts rated 15 amperes 110 V. a.c. Operates on low coil current and adaptable to similar applications.

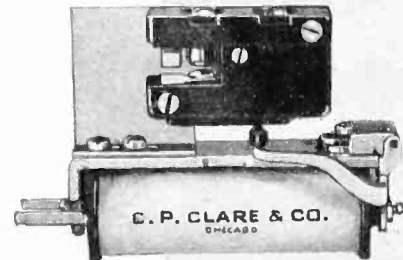

Write for Clare Data Book and Catalog today.

STABILIZED A. C. VOLTAGE UP TO 25 KVA

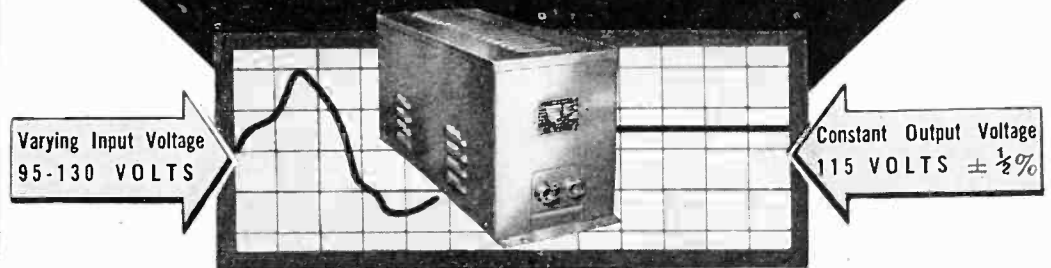

INSTANTANEOUS ACTION

NO MOVING PARTS

When a precision electrical device or a critical process is powered from an AC line, a Raytheon Voltage Stabilizer will permanently eliminate all of the detrimental effects caused by AC line voltage fluctuations. Made for all commercial voltages and frequencies, single or three phase.

Raytheon's twelve years of experience in successfully applying the Stabilizer to hundreds of perplexing voltage fluctuation problems is at your service. It will pay you to take advantage of our engineering skill.

Write for Bulletin DL48-71 JE describing Raytheon Stabilizers.

RAYTHEON MANUFACTURING CO.
100 Willow Street, WALTHAM, Massachusetts

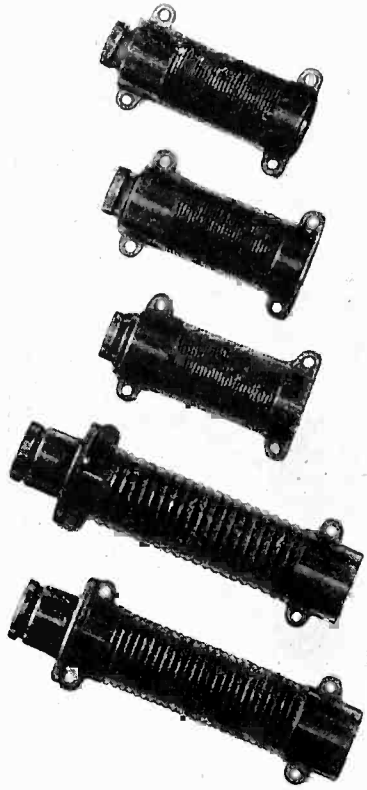

INSUROK

for Assured Performance

Normally, consumers look upon a radio as a unit, and upon unit performance critical judgments are made. In reality a radio comprises many units, each contributing its share to the performance of the whole. Therefore, many manufacturers use INSUROK, the precision plastic, for scores of parts. Why? They know INSUROK is wholly dependable; constant in its physical, chemical and dielectric characteristics; that it gives an extra measure of quality and performance. We urge your most searching investigation of INSUROK.

**PRECISION PLASTICS for
Radio - Television - Communication**

The RICHARDSON COMPANY

MELROSE PARK, CHICAGO, ILL. FOUNDED 1858 LOCKLAND, CINCINNATI, OHIO
NEW BRUNSWICK, N. J. INDIANAPOLIS, IND.
DETROIT OFFICE 4-252 G. M. BUILDING, PHONE MADISON 9386
NEW YORK OFFICE 75 WEST STREET, PHONE WHITEHALL 4-4487



UNBRAKO
REG. U.S. PAT. OFFICE
**SCREW
PRODUCTS**

IF you're careful about the selection of screws for electrical service, you'll compare. And having compared you'll choose "Unbrako" Products for their uniformity and strength; for their unique self-locking feature; for their knurled heads with a non-slip grip that saves assembling time. Complete range of sizes from number 4 up. Write for samples and literature.

STANDARD PRESSED STEEL CO.
Box 596, JENKINTOWN, PENNA.

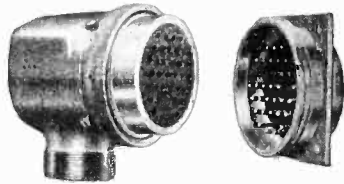

CANNON ELECTRICAL CONNECTORS

Save Time and Money . . . Increase Efficiency

IN the transmission of electrical energy—electronic or otherwise—wherever cables are required, problems of efficient connection and quick disconnection are solved by CANNON Cable Connectors. Manufactured up to a standard and not down to a price. CANNON Multiple-Contact Electrical Connectors are the choice of the leading makers of fine equipment used in the fields of Sound, Aeronautics, Geophysical Research, Instrument Control on Ships and on Laboratory Panels.

Illustrated Bulletins contain valuable information on Plug Problems. Bulletin "P & O" devoted exclusively to Sound. Please specify your requirements when requesting bulletins.

CANNON ELECTRIC DEVELOPMENT CO.

3209 HUMBOLDT ST., LOS ANGELES, CALIFORNIA
Eastern Sales Office: 220 Fifth Ave., New York, N. Y.
Chicago: Kelburn Engineering Co., 600 W. Jackson Blvd.



CANNON PLUGS

degrees and at 5,000 cycles per second will be far less than 30 degrees. These variations in directional characteristics are undesirable and can be eliminated by constructing the microphone in such a way that the effective length of the line becomes shorter with increasing frequency. Therefore the response range is divided into three bands to produce directional characteristics which do not vary too widely. The bands selected were roughly 200-750 cycles per second, 750-2100 cycles per second, and 2100-5000 cycles per second. The simplest way to obtain the desired low frequency cutoff at about 150 cycles per second is through the use of a diaphragm-type pressure microphone in which the normal low frequency response is obtained by a resonant circuit consisting of the case volume and an air mass in a tube connecting the case volume to the outside. By closing the tube the stiffness of the moving system and case may be used to secure the low frequency cutoff. The upper cutoff frequency for the low and mid-frequency pipes is obtained by inserting in each pipe close to the pickup unit a plug with a small hole. The inertance so introduced in combination with the pipe impedance and the volume between the microphone diaphragm and the pipe termination, provides the desired cutoff. The cutoff at 5,000 cycles per second is obtained by providing a small compliance between the microphone diaphragm and the ends of the pipes. No inertances are inserted in the high frequency pipes.

• • •

Ionization Gauge

AN IONIZATION GAUGE circuit which eliminates the use of the expensive plate microammeter employed in conventional ionization gauges is described in "Magic Eye Ionization Gauge" by Louis N. Ridenour in the March 1941 issue of *The Review of Scientific Instruments*. The use of the "magic eye" tube, because it is relatively inexpensive, increases the utility of the ionization gauge method of measuring gas and vapor pressures in the range from 10^{-3} to 10^{-7} mm Hg.

The circuit diagram is shown in the accompanying figure. The plate current of the gauge tube B79510 flows through one of the resistors R_1 - R_6 depending on the setting of the switch S_1 . The resulting potential drop causes the shadow angle of the 6E5 to widen and it may be brought back to its original setting by adjustment of the potentiometer R_6 , whose position then indicates the magnitude of the gauge plate current. The shadow angle of the 6E5 can be reproducibly checked to about 1/50 of full scale on the resistor R_6 , so that the smallest current which can be read with this choice of resistors shown is 5×10^{-8} ampere.

Before use, the circuit is adjusted in the following manner. A sealed-off three-electrode tube of any sort is used in place of the ionization gauge tube

JAGABI "LUBRI-TACT" LABORATORY RHEOSTATS

Four Sizes, Seventy-Six
Ratings, Lubricated
Sliding Contact

BULLETIN 1820-E

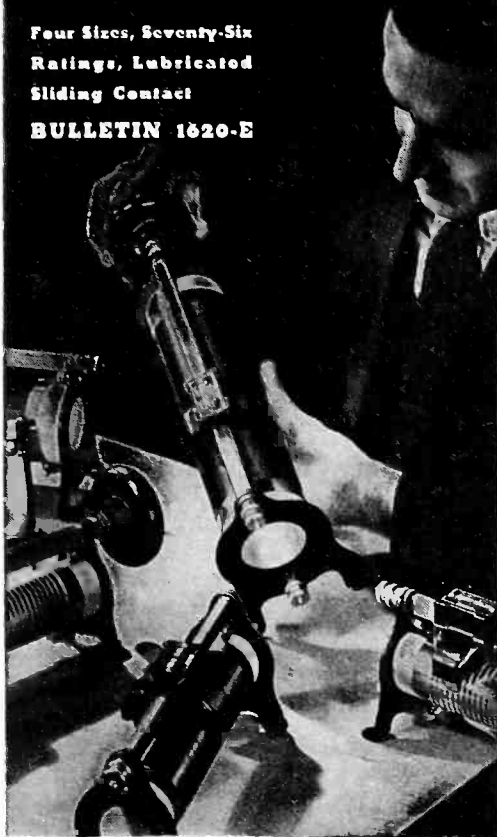

JAMES G. BIDDLE CO.
Electrical Instruments
1211-13 Arch Street Philadelphia, Pa.

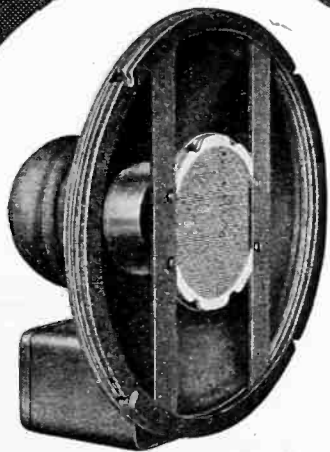

for **FM** a new Cinaxial Speaker System

For FM and other high fidelity uses. Available to fit 12 inch baffle mounting. Special bulletin available on request. Write Dept. E. SEE us at the CHICAGO SHOW JUNE 10th to 13th . . . Booths 623-625.

**CINAUDAGRAPH
SPEAKERS, INC.**

921 W. Van Buren St.
CHICAGO, ILL.

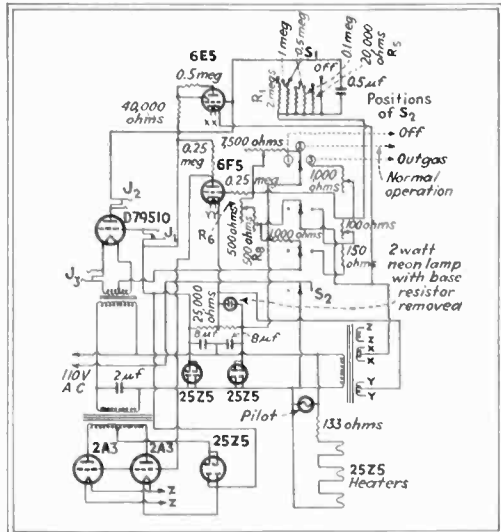

Circuit diagram of ionization gauge

and sealed to a vacuum system for the preliminary tests. The behavior of the circuit does not depend on the characteristics of the gauge tube. With S_2 turned to the normal position, the resistor R_7 is adjusted until the grid current of the gauge tube, measured by a milliammeter plugged into J_1 , is 10 ma. This is the grid current for which this circuit has been designed. Smaller or larger grid currents may be used by changing the values of the resistors in the circuit. The switch S_1 is thrown to the "off" position, the potentiometer R_6 is put on the extreme position marked L and the resistor R_8 is adjusted until the shadow of the 6E5 is closed. Switch S_2 is now thrown to the "outgas" position and R_8 is adjusted until the outgassing grid current, as read by a milliammeter plugged into J_2 , has the value required to bring the grid of the gauge tube to a safe red

• • •

AIRCRAFT LOCATORS

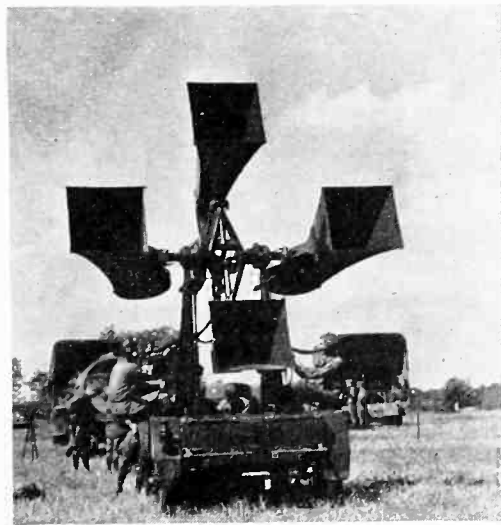

The four horns, which may be changed in position about both vertical and horizontal axes, form a part of the equipment used by the United States Army in detecting the positions of enemy aircraft



*Complete
Radio Receiving Station!*

Covers substantially everything in the radio spectrum. You can use one, two or all three units simultaneously through the separate antenna switch. Monitoring speaker connects to any one; in addition separate speakers can be connected as you wish. Headphone monitoring jacks ties into output of any one of the three receivers.

The only receiving unit made which tunes continuously from 1.82 to 2730 meters (165 mc to 110 kc). A few of its services are: time signals, coastal and ship telegraph and telephone, aircraft beacons, standard broadcast, relay broadcast, aviation, amateur, international short wave bands, police, government, press and educational channels. FM broadcast and relay bands with high fidelity audio for best FM reception. Is 20½" wide, 30" high, 18" deep. Sells complete for \$450.00.

the **hallicrafters** co.
CHICAGO, U. S. A.
USED BY 33 GOVERNMENTS
SOLD IN 89 COUNTRIES

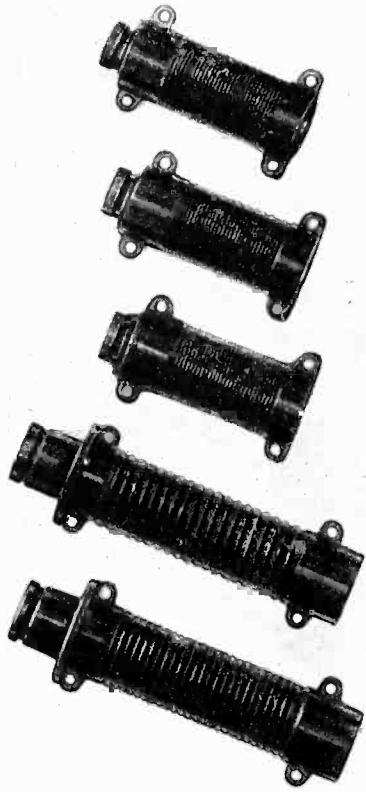

INSUROK

for Assured Performance

Normally, consumers look upon a radio as a unit, and upon unit performance critical judgments are made. In reality a radio comprises many units, each contributing its share to the performance of the whole. Therefore, many manufacturers use INSUROK, the precision plastic, for scores of parts. Why? They know INSUROK is wholly dependable; constant in its physical, chemical and dielectric characteristics; that it gives an extra measure of quality and performance. We urge your most searching investigation of INSUROK.

**PRECISION PLASTICS for
Radio - Television - Communication**

The RICHARDSON COMPANY

MELROSE PARK, CHICAGO ILL. FOUNDED 1858 LOCKLAND, CINCINNATI OHIO
NEW BRUNSWICK, N. J. INDIANAPOLIS IND.
DETROIT OFFICE, 4-252 G. M. BUILDING, PHONE MADISON 9386
NEW YORK OFFICE, 75 WEST STREET, PHONE WHITEHALL 4-4487



UNBRAKO

REG. U.S. PAT. OFFICE

**SCREW
PRODUCTS**

STANDARD PRESSED STEEL CO.

Box 596, JENKINTOWN, PENNA.

IF you're careful about the selection of screws for electrical service, you'll compare. And having compared you'll choose "Unbrako" Products for their uniformity and strength; for their unique self-locking feature; for their knurled heads with a non-slip grip that saves assembling time. Complete range of sizes from number 4 up. Write for samples and literature.

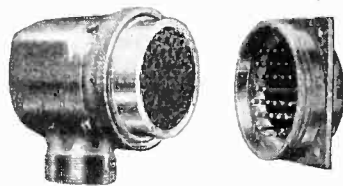

CANNON ELECTRICAL CONNECTORS

Save Time and Money . . . Increase Efficiency

IN the transmission of electrical energy—electronic or otherwise—wherever cables are required, problems of efficient connection and quick disconnection are solved by CANNON Cable Connectors. Manufactured up to a standard and not down to a price. CANNON Multiple-Contact Electrical Connectors are the choice of the leading makers of fine equipment used in the fields of Sound, Aeronautics, Geophysical Research, Instrument Control on Ships and on Laboratory Panels.

Illustrated Bulletins contain valuable information on Plug Problems. Bulletin "P & O" devoted exclusively to Sound. Please specify your requirements when requesting bulletins.

CANNON ELECTRIC DEVELOPMENT CO.

3209 HUMBOLDT ST., LOS ANGELES, CALIFORNIA

Eastern Sales Office: 220 Fifth Ave., New York, N. Y.
Chicago: Kelburn Engineering Co., 600 W. Jackson Blvd.



CANNON PLUGS

degrees and at 5,000 cycles per second will be far less than 30 degrees. These variations in directional characteristics are undesirable and can be eliminated by constructing the microphone in such a way that the effective length of the line becomes shorter with increasing frequency. Therefore the response range is divided into three bands to produce directional characteristics which do not vary too widely. The bands selected were roughly 200-750 cycles per second, 750-2100 cycles per second, and 2100-5000 cycles per second. The simplest way to obtain the desired low frequency cutoff at about 150 cycles per second is through the use of a diaphragm-type pressure microphone in which the normal low frequency response is obtained by a resonant circuit consisting of the case volume and an air mass in a tube connecting the case volume to the outside. By closing the tube the stiffness of the moving system and case may be used to secure the low frequency cutoff. The upper cutoff frequency for the low and mid-frequency pipes is obtained by inserting in each pipe close to the pickup unit a plug with a small hole. The inductance so introduced in combination with the pipe impedance and the volume between the microphone diaphragm and the pipe termination, provides the desired cutoff. The cutoff at 5,000 cycles per second is obtained by providing a small compliance between the microphone diaphragm and the ends of the pipes. No inductances are inserted in the high frequency pipes.

• • •

Ionization Gauge

AN IONIZATION GAUGE circuit which eliminates the use of the expensive plate microammeter employed in conventional ionization gauges is described in "Magic Eye Ionization Gauge" by Louis N. Ridenour in the March 1941 issue of *The Review of Scientific Instruments*. The use of the "magic eye" tube, because it is relatively inexpensive, increases the utility of the ionization gauge method of measuring gas and vapor pressures in the range from 10^{-3} to 10^{-7} mm Hg.

The circuit diagram is shown in the accompanying figure. The plate current of the gauge tube B79510 flows through one of the resistors R_1 - R_6 depending on the setting of the switch S_1 . The resulting potential drop causes the shadow angle of the 6E5 to widen and it may be brought back to its original setting by adjustment of the potentiometer R_6 , whose position then indicates the magnitude of the gauge plate current. The shadow angle of the 6E5 can be reproducibly checked to about 1/50 of full scale on the resistor R_6 , so that the smallest current which can be read with this choice of resistors shown is 5×10^{-8} ampere.

Before use, the circuit is adjusted in the following manner. A sealed-off three-electrode tube of any sort is used in place of the ionization gauge tube

JAGABI "LUBRI-TACT" LABORATORY RHEOSTATS

Four Sizes, Seventy-Six
Ratings, Lubricated
Sliding Contact
BULLETIN 1620-E

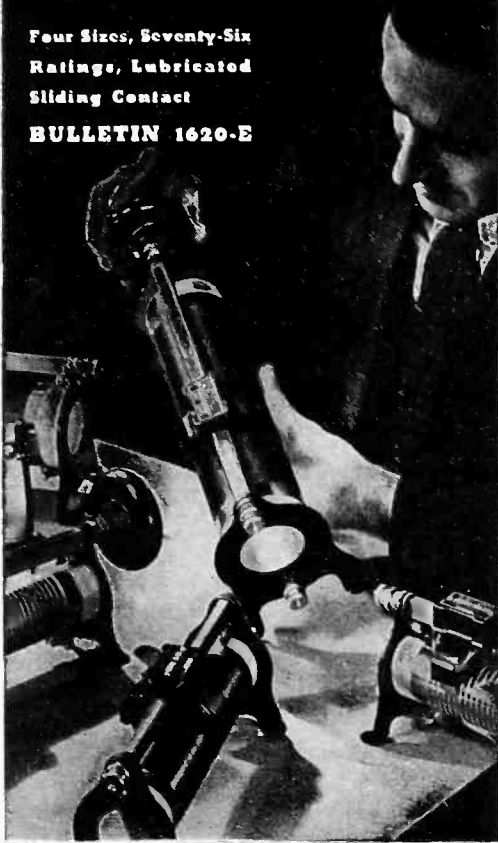

JAMES G. BIDDLE CO.
Electrical Instruments
1211-13 Arch Street Philadelphia, Pa.

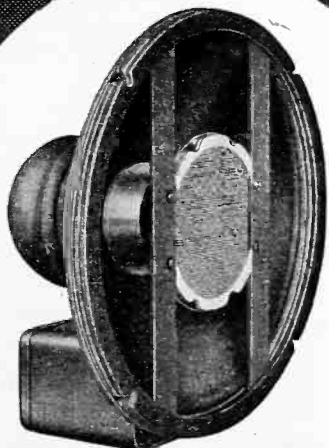

for **FM** a new Cinaxial Speaker System

For FM and other high fidelity uses. Available to fit 12 inch baffle mounting. Special bulletin available on request. Write Dept. E. SEE us at the CHICAGO SHOW JUNE 10th to 13th . . . Booths 623-625.

**CINAUDAGRAPH
SPEAKERS, INC.**
921 W. Van Buren St.
CHICAGO, ILL.

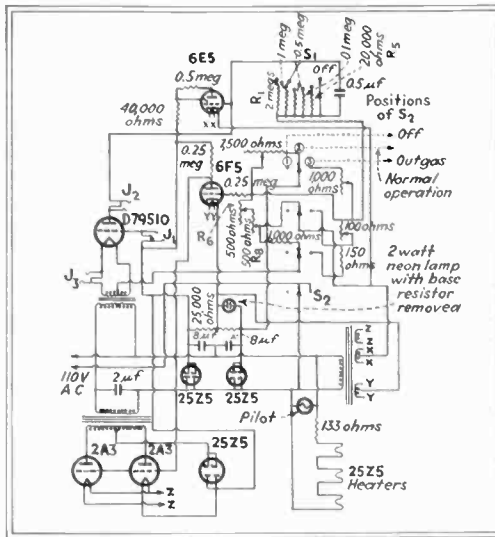

Circuit diagram of ionization gauge

and sealed to a vacuum system for the preliminary tests. The behavior of the circuit does not depend on the characteristics of the gauge tube. With S_2 turned to the normal position, the resistor R_7 is adjusted until the grid current of the gauge tube, measured by a milliammeter plugged into J_1 , is 10 ma. This is the grid current for which this circuit has been designed. Smaller or larger grid currents may be used by changing the values of the resistors in the circuit. The switch S_1 is thrown to the "off" position, the potentiometer R_6 is put on the extreme position marked L and the resistor R_8 is adjusted until the shadow of the 6E5 is closed. Switch S_2 is now thrown to the "outgas" position and R_8 is adjusted until the outgassing grid current, as read by a milliammeter plugged into J_1 , has the value required to bring the grid of the gauge tube to a safe red

• • •

AIRCRAFT LOCATORS

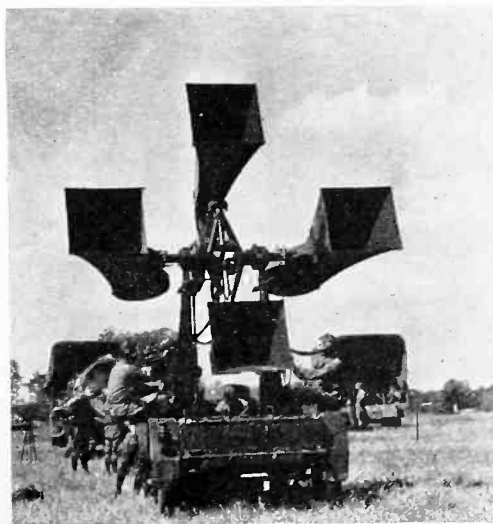

The four horns, which may be changed in position about both vertical and horizontal axes, form a part of the equipment used by the United States Army in detecting the positions of enemy aircraft



**Complete
Radio Receiving Station!**

Covers substantially everything in the radio spectrum. You can use one, two or all three units simultaneously through the separate antenna switch. Monitoring speaker connects to any one; in addition separate speakers can be connected as you wish. Headphone monitoring jack ties into output of any one of the three receivers.

The only receiving unit made which tunes continuously from 1.82 to 2730 meters (165 mc to 110 kc). A few of its services are: time signals, coastal and ship telegraph and telephone, aircraft beacons, standard broadcast, relay broadcast, aviation, amateur, international short wave bands, police, government, press and educational channels. FM broadcast and relay bands with high fidelity audio for best FM reception. Is 20½" wide, 30" high, 18" deep. Sells complete for \$450.00.

the **hallicrafters** co.
CHICAGO, U. S. A.
USED BY 33 GOVERNMENTS
SOLD IN 89 COUNTRIES

To Serve Well the
Professional Radioman

CREI CLASS IN ACTION



Each CREI Student
Receives Individual, Personal
Service as a "Class of One"

Enrollment as a CREI Student involves much more than subscribing to a series of printed lessons. Each student is assigned a personal instructor who carefully guides him through his studies; who promptly offers additional explanation when necessary and who carefully corrects and explains all errors in the written examination sent in for each lesson text.

This personal supervision, guidance and consultation enjoyed by each CREI student is but one of the important essential services extended to students of this institute. We feel that this personalized instruction is one of the reasons why CREI men are qualified to go after the better jobs and get them.

The success of an educational institution is not marked by dollars and cents . . . but by the achievements and results enjoyed by its graduates. CREI is interested in serious-minded professional radiomen who realize the value of a planned program of technical training . . . and we point with proof and pride to the more than 5000 professional radiomen who are now enjoying the benefits of CREI training in Practical Radio Engineering.

These facts are important to you . . . and to EVERY MAN who is seeking a way to improve his position in the radio field. We will be pleased to send our booklet and pertinent facts upon request.

"Since 1927"

CAPITOL RADIO

ENGINEERING INSTITUTE

E. H. Rietzke, President

Dept. E-5, 3224 - 16th St., N.W.
Washington, D. C.

heat. At the grid voltage used in this circuit, the current required for a Western Electric D79510 gauge tube is about 70 ma. R_{10} is now adjusted until the eye is just closed, with S_1 remaining in the off position. The circuit is now ready for use. The adjustments of R_7 and R_8 will remain constant as long as the same 6F5 tube is used, and the settings of R_8 and R_{10} will remain the same until the 6E5 tube is changed.

Because the current passing through R_7 , R_8 , R_{11} , and R_9 is stabilized at 10 ma, it is clear that in the normal position of S_2 the grid voltage of the 6E5 tube is $e_g = i_p R_p - 10^{-2} (R_8 + R_9)$ where i_p is the gauge tube plate current and R_p is the resistance of whichever of the resistors $R_1 - R_6$ is in the circuit. The circuit has already been adjusted so that the eye is closed when $R_p = R_9 = 0$, so that when R_p is not zero and R_9 is adjusted to close the eye, the voltage drop across R_p must be equal to that across R_9 .

$$i_p R_p = 10^{-2} R_9$$

$$\text{or } i_p = 10^{-2} R_9 / R_p$$

The value of R_p is known and that of R_9 may be read from a scale on the potentiometer. To save weight the power supply used is a transformerless doubler. If desired, a plate microammeter or a protective relay may be used in the plate circuit of the gauge tube to stop diffusion pumps or other apparatus when the pressure in the vacuum system becomes too great.

• • •

Telephone Transmission Circuits for Radio Program

TELEPHONE TRANSMISSION LINES form an essential link in present-day network broadcasting. The basic engineering considerations for the design of these circuits is presented in an article entitled "Engineering Requirements for Program Transmission Circuits," by F. A. Cowan, R. G. McCurdy and I. E. Lattimer in the April 1940 issue of *Electrical Engineering*. The total length of these circuits is more than 110,000 miles, and it is not unusual for a program originating at some point on a network to traverse more than 7,000 miles of circuit before being broadcast by the most remote station.

The detailed planning of these circuits requires consideration of: 1. The number of circuits likely to be required, section by section, over each route. 2. The provision for reliability, flexibility, operation and supervision, essential to a high-grade network service. 3. The transmission requirements or electrical characteristics necessary to achieve a natural reproduction of the program.

The number of circuits required changes rapidly because of the changing requirements of broadcasting. In addition to full-time circuits there are intermittent requirements occasioned by special events and other short period needs, some of which involve networks almost as extensive as the

Rauland

A NAME TO REMEMBER

Rare are the names that have traveled all the long way down the shifting, changing road of radio. Today, just as it was twenty years ago, RAULAND is a name that has won both the respect and the patronage of the industry. Always rich in resources of men and machinery—always motivated by standards of scientific precision both in its engineering and manufacturing activities, RAULAND is a symbol of preeminence in the field of electronics and in its specialized phases of communication and sound amplification. It is indeed, a name to be remembered.

DEFENSE COMES FIRST! Today, the major portion of RAULAND's engineering and manufacturing capacity is devoted to an important phase of the national defense program in the field of radio. RAULAND has, however, continued to serve a limited number of valued accounts. With the passing of the emergency, RAULAND, with vastly increased capacity and resources, looks forward to serving the radio industry again.

We'd like to put your name on our mailing list for periodical releases of timely information.

"It will pay you to remember RAULAND."

THE RAULAND CORPORATION

3333 Belmont Avenue, Chicago, Illinois

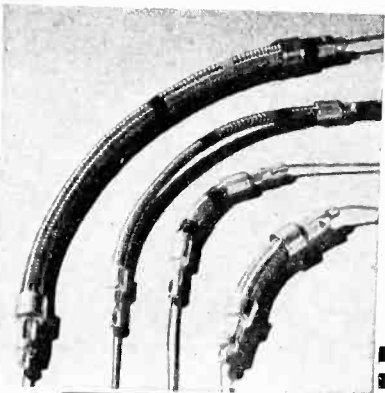

GLASOHMS

★ Tiny, flexible, inexpensive power resistors insulated with real glass. Glasohms (Reg. Trade Mark) have fibre-glass core for wire winding, protected by braided fibre-glass covering. Used extensively in instruments, electronic and radio assemblies. Can be operated at temperatures up to 1000° F. Frequently used as miniature heating elements. 1-watt and 2-watt per body inch ratings; 5 to 700 and 5 to 750 ohms per body inch. Made in any length. Interested? Write for samples, specs., quotations, on your requirements.

CLAROSTAT

MANUFACTURING CO.
Incorporated

285 North Sixth St.
Brooklyn, N. Y.



full-time networks. In addition, reliability of service requires provision for rerouting the networks in case of trouble. When required, there are a number of circuits normally assigned to other services, which are arranged to be readily adaptable to program service to supplement the regular facilities.

To meet the requirements because of changes in program, elaborate switching must take place within a few seconds at a number of points throughout the networks. To do this special equipment, some of it under remote control from selected points, has been developed. Most of the switching of program circuits is done at about 25 points throughout the country on the major networks. On an average more than 25,000 switching operations are performed per month at these 25 points. During the busy hours of any typical evening there may be something over 500 men on duty at all of the offices throughout the networks.

The quality of the transmission circuit must be such that program material is transmitted with a high degree of naturalness. In expressing the requirements for satisfactory transmission, frequency range, attenuation distortion, delay distortion, nonlinearity and noise are used as indices of quality. The requirement for high quality circuits over short distances is not difficult technically, and does not in general require expensive equipment. However, the very large system made up of many sections of circuits in tandem makes it necessary to design and operate the individual circuits to very close limits so that the cumulative discrepancies in a whole network will not exceed tolerable values.

The major present-day program networks are set up to transmit a frequency band with an upper limit of

• • •

"HE FLOATS THROUGH THE AIR"



Torger Tokle, 22-year old Norwegian skier, who recently set a new record for ski jumping, is shown jumping with a short-wave transmitter strapped to his back. He describes his jump through a microphone welded to a catcher's baseball mask which he wore. This was the first broadcast of this type

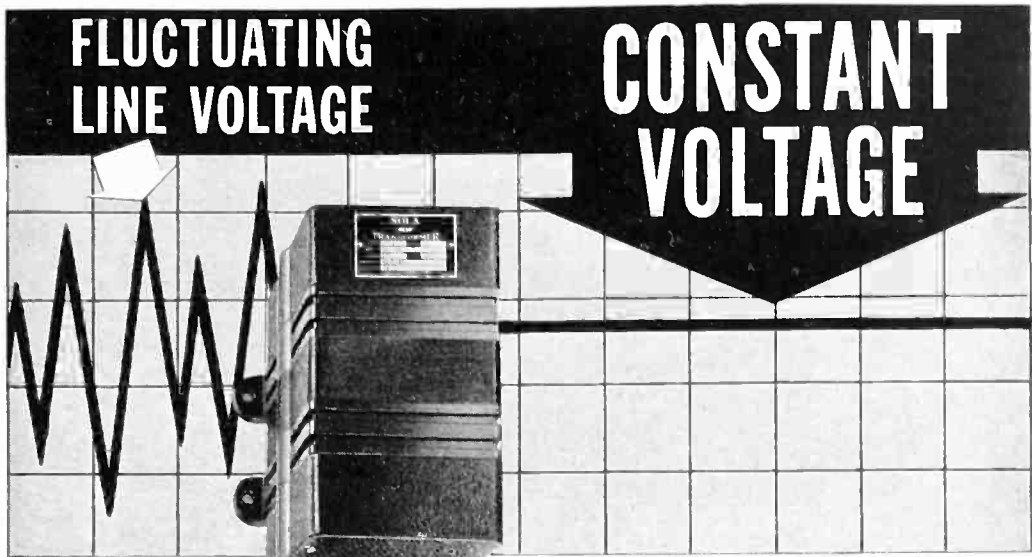

Ask For
BULLETIN
DCV-74

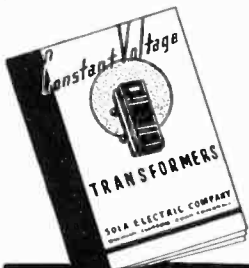

Whether it's 1 VA for an instrument or 10 KVA for a production line—here's constant, stable voltage for you at all times, even though the line voltage varies as much as thirty percent.

They are fully automatic and instantaneous in operation—have no moving parts—require no maintenance—and are self-protecting against short circuit.

You can build a SOLA CONSTANT VOLTAGE TRANSFORMER into your product, or incorporate it in your production line or laboratory and know that every test will be made under identical line conditions. Compact—economical. Standard designs are available, or units can be built to your special specifications.

SOLA ELECTRIC COMPANY, 2525 Clybourn Ave., Chicago, Ill.

SOLA

Constant Voltage TRANSFORMERS

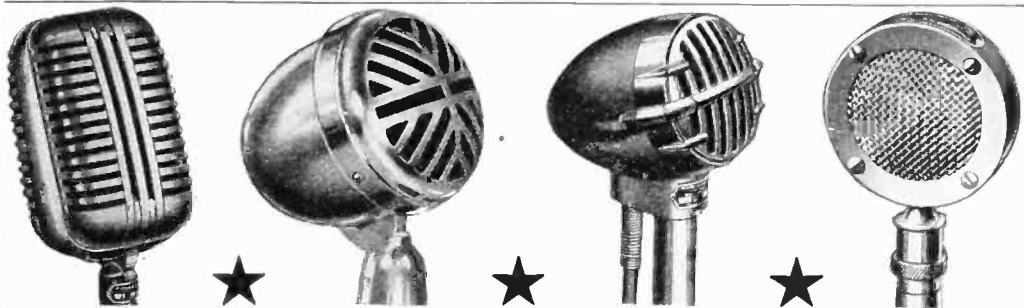

A HIGHLY RECOMMENDED QUARTET of Astatic Radio Performers

Microphones so dependable, sturdy, efficient and good looking as to merit the praise they receive wherever they are in use. Veteran amateurs, sound technicians, professional artists and home enthusiasts making their own recordings . . . these, and many others . . . applaud the performance of Astatic Microphones. Unexcelled performance and proven practicability make Astatic products favorites among amateurs, service men, dealers and manufacturers alike. Astatic Microphones are available in many models with frequency response characteristic to meet every demand.

See your Radio Parts Jobber
or write for Astatic Catalog.



ASTATIC MICROPHONE

IN CANADA: CANADIAN
ASTATIC Ltd., TORONTO, ONT.

YOUNGSTOWN
OHIO



ASTATIC CRYSTAL PRODUCTS LICENSED UNDER BRUSH DEVELOPMENT CO. PATENTS

SPRINGS by HUNTER

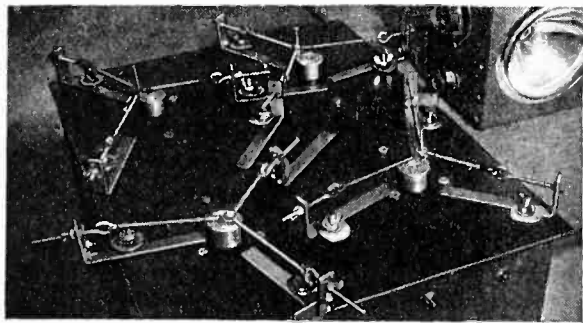

are ENGINEERED Springs!

Spring problems? . . . Come to Hunter for *engineered* solutions. You're assured of the *right spring action* to fit the job . . . springs that always do their part in maintaining the reputation of your product.

In many of America's most famous products you'll find that springs by Hunter are standard, that they safeguard quality and goodwill yet hold down costs and increase profits!

Hunter has the equipment, the facilities, the men . . . ready to cooperate in giving you the springs you want. Write today—now, while you're thinking about it. There's no obligation.

HUNTER PRESSED STEEL COMPANY
LANSDALE, PENNSYLVANIA

Where *Performance Counts* Look to "PRECISION"

Industrial and Laboratory Testers

"PRECISION" manufactured to "PRECISION" standards of accuracy, workmanship and materials guaranteed to give lasting satisfaction under the most exacting conditions of service.

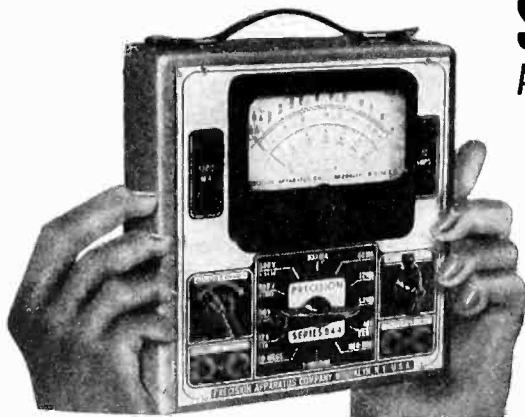

SERIES 844—34 RANGES

AC-DC Volt-Ohm-Decibel-Milliammeter

6000 VOLTS • 12 AMPS
10 MEGOHMS • 70 DB

The Series 844 is representative of a large selection of AC-DC Multi-range testers specifically designed to meet the requirements of laboratory and production testing.

- Large, easy reading, 400 microampere meter
- All commonly employed ranges at only 2 pin jacks
- Rapid, positive rotary range selection
- 1% wire wound shunts and matched multipliers
- 2% DC—3% AC overall accuracy
- Rub-proof deeply etched panel markings.

Series 844L—(illustrated)—in hardwood open face walnut finished case with leather carrying handle.

Net price (less batteries and test leads) . . . \$22.95

WRITE FOR "PRECISION" CATALOG 41-E describing more than 40 radio and electrical test equipment models . . . Tube Testers, Combination Tube and Set Testers, AC-DC Multi-range Testers, Signal Generators, Industrial Circuit Testers, etc.

PRECISION TEST EQUIPMENT

INDUSTRIAL • LABORATORY • RADIO • TELEVISION

PRECISION APPARATUS COMPANY • 647 KENT AVENUE • BROOKLYN, N. Y.
Export Division: 458 Broadway, New York City, U.S.A. Cable Address: Morhanex

about 5,000 cycles per second. All facilities installed in the last ten years, however, have been designed to be adaptable to the future transmission of frequencies up to 8,000 cycles per second. In 1933 experimental circuits were set up between Philadelphia and Washington to transmit frequency bands up to 15,000 cycles per second. Also, a number of studio transmitters have been provided to transmit up to as high as 15,000 cycles per second.

An important consideration is the amount of attenuation and delay or phase distortion to be permitted within the frequency band. On very long circuits experience has shown that even with automatic regulating features and careful operation residual variations which may amount to several decibels may develop as a result of changing temperature or other conditions. These variations must be kept within tolerable limits by readjustment of the equalizers from time to time. In practice, circuits tend to have a lower velocity of transmission near the edges of the frequency band than in the middle portions. This results in frequency components near the edges being delayed as compared to the middle portions of the band. This difference in time of transmission is called delay distortion of the circuit. Listening tests have shown that it becomes noticeable if at the highest transmitted frequency the delay is more than eight milliseconds greater than at 1,000 cycles per second, and if at 100 cycles per second it is more than about 15 milliseconds greater than at 1,000 cycles per second. This delay is controlled by loading system amplifiers, repeating coils, and other elements of the circuit.

. . .

RECORDING HEART BEATS



Shown at the recent Health Defense Exposition in Los Angeles was the stetho-cardiette and cardioscope shown above which makes audible as well as visible the pulsations of heart action in a human being

COILS

Electrical Windings



A COMPETENT and experienced organization devoted to the design and manufacture of coil windings. Paper interlayer sections—form wound and bobbin wound coils.

Equipped for prompt production on quantity or small orders.

REPRESENTATIVES

W. A. JORDAN
295 Madison Ave.,
New York, N. Y.

PARAGON SALES CO.
(C. H. Fryburg)
402 Cherry St.,
Philadelphia, Pa.

GILBERT GISLASON
82 St. Paul St.,
Rochester, N. Y.

A. J. LOEB SALES CO.
1836 Euclid Ave.,
Cleveland, Ohio

MAGNETIC WINDINGS COMPANY
Sixteenth and Butler Streets EASTON, PENNA.

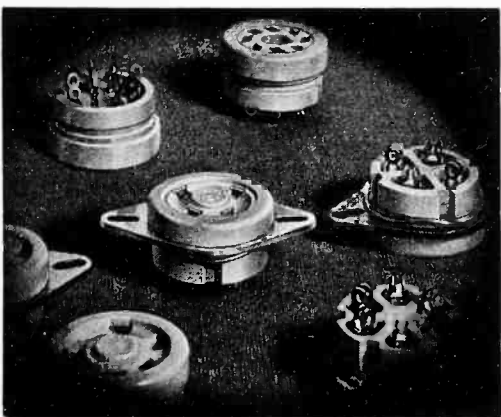

DESIGNED for APPLICATION

MODERN SOCKETS for MODERN TUBES! Long flashover path to chassis permits use with transmitting tubes, 866 rectifiers, etc. Ideal for mounting on rugged thick cast aluminum chassis now being used on much of the better commercial equipment. Long leakage path between contacts. Contacts are type proven by hundreds of millions already in government, commercial and broadcast service, to be extremely dependable. Sockets may be mounted either with or without metal flange. Mount in standard size chassis hole. All types have barrier between contacts and chassis. All but octal also have barriers between individual contacts in addition.

Catalogue Upon Request

JAMES MILLEN MFG. CO. INC.
150 EXCHANGE ST. MALDEN, MASS.

30 to 340 Mc Wavemeter

(Continued from page 38)

somewhat different form. As the condenser shaft carries current and sets up an electromagnetic field in its vicinity, a conductor within this field will accordingly have an emf induced in it. The coupling element therefore was made in the form of a straight wire placed near the condenser shaft and connected to the microammeter and crystal rectifier. All direct coupling with the generator was eliminated by this arrangement. A second or third conductor would probably increase the coupling, but it was not desirable or necessary.

Figure 2 shows a schematic diagram in which the shield and ground connection is indicated. The resonance indicating circuit is not connected to the shield. The sensitivity of the resonance indicator may be decidedly affected by connection to the shield and by the point on the resonance indicating circuit at which the connection is made. The circuit arrangement used was most desirable for the wide range of frequencies involved. Greater sensitivity may be possible over a limited frequency range by using a connection from the appropriate point of the resonance indicator to the shield.

The crystal detector or rectifier is one of the important parts of the instrument. For many years this Bureau has employed galena crystal rectifiers in resonance indicators for frequency meters. The chief advantage has been the use of small currents and resultant very slight interaction between frequency meter and resonance indicating circuits. The simplicity, small size, vastly greater sensitivity, and low cost of the crystal compared to a vacuum-tube voltmeter and its batteries, were other advantages. The adjustment of the "cat-whisker" was not critical if fairly uniform crystals were used. The adjustment was not changed over long periods of time. A fixed crystal appeared to have certain advantages, but some obtained commercially were found to be useless.



OHMITE RESISTORS

Sizes from 2½" diameter x 20" long to 5/16" diameter x 1" long—on hand and ready to be made into the exact resistors you require. 1 watt or 1000 watts. Fixed, adjustable or tapped. Regular, precision or non-inductive. Over 600 resistance values in completely finished resistors carried in stock for immediate shipment. Special units engineered for unusual applications.

Write on company letterhead for Ohmite Industrial Catalog and Manual No. 40.

OHMITE MANUFACTURING CO.
4817 Flournoy Street, Chicago, U. S. A.

OHMITE

RHEOSTATS RESISTORS TAP SWITCHES

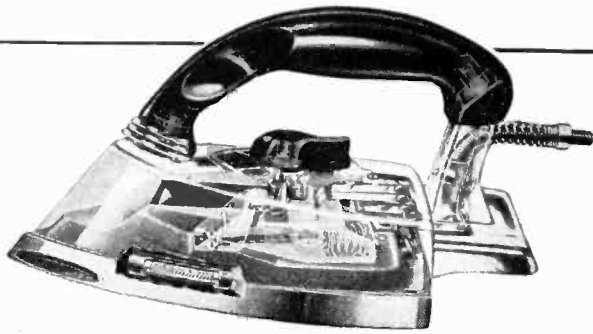

CLOTHES MAKE THE IRON

Whether it's silk, wool or cotton that's to be ironed, this General Electric "Moderne" Iron reaches and maintains exact temperature required. Uniform sensitivity to temperature change is assured by Wilco Thermometals (thermostatic bimetals) while dependable "on and off" action is provided by Wilco Electrical Contacts.

For defense work—for commercial work—you can depend on Wilco

Thermometals to provide absolute accuracy of temperature control (or reaction from temperature change); and Wilco Electrical Contacts to provide dependable service. Every Wilco order is supervised *personally*—assurance your shipments will arrive "as specified." Write The H. A. Wilson Co., 105 Chestnut St., Newark, N. J. Branches: Chicago and Detroit.

Now more than ever
Personal
Attention Counts



THE
H. A. WILSON CO.

S. S. White MOLDED RESISTORS

The "All-Weather" Resistors

RANGE OF VALUES
S. S. WHITE RESISTORS

STANDARD RANGE —
1000 ohms to 10 megohms

HIGH VALUES —
15 to 1,000,000 megohms

SEND FOR RESISTOR
BULLETIN 37

It contains illustrations of the different types of S. S. White Molded Resistors and gives details about construction, dimensions, etc. A copy, with Price List, mailed on request. Write for it today.

NOISE TESTED

LOW NOISE LEVEL is a feature of all S. S. White Molded Resistors. But as an accommodation to manufacturers of equipment in which noiseless operation is of first importance, S. S. White will supply resistors in the Standard Range of 1000 ohms to 10 megohms, noise tested to the following standard:

"For the complete audio frequency range, resistors shall have less noise than corresponds to a change of resistance of 1 part in 1,000,000."

Each and every resistor on such orders is tested and guaranteed to meet these specifications and can therefore be used as received without further test. This is one reason why S. S. White Resistors are so widely used in quality radio, telephone, telegraph, sound picture, television and other commercial, industrial and scientific equipment.

S. S. WHITE

The S. S. White Dental Mfg. Co.

INDUSTRIAL DIVISION

Department R, 10 East 40th St., New York, N. Y.

A new form of fixed crystal was made using silicon in the shape of a wide flat wedge. A short length of phosphor-bronze was formed into a coiled spring so that a point near the free end of the wire pressed firmly against the sharp edge of the silicon. This was found to be very sensitive and unaffected by jarring. The width of the crystal insured contact at all times. Experience of two years with two such crystals has shown no difficulty from the sensitivity changing or the wire coming off the crystal, although one has been transported occasionally in a truck. Crystal rectifiers of this type or any other should be selected for greatest sensitivity.

The coils are shown in Fig. 1, and with one exception are wound of $\frac{3}{8}$ -inch outside diameter copper tubing. The dimensions of the coils and the frequency ranges are given in the table on page 38.

Another important part of a frequency meter is the dial and index for reading the setting. There are two errors often made in selecting such devices; the scale may be poorly divided with coarse graduations and an index mounted on a different plane so that the reading depends upon the position from which it is taken, or the scale may be unduly extended to such an extent that owing to mechanical backlash, or to imperfections in the resonance response, the expensive scale is unwarranted and only a portion of the divisions used. A vernier scale is often desirable, but after using a 100-division scale with slow-motion adjustment on a previous model, a precision dial with 200 divisions in 180 degrees of rotation was selected for this instrument as giving ample precision in reading. The dial is 4 inches in diameter with an index mounted on the same level as the dial. A small lens is arranged to be mounted above the index, but is seldom used. In order to eliminate coupling effects from the hand the control knob is mounted 3 inches above the dial on an insulating rod.

Earlier in this paper the advantage of the absorption type frequency meter in the measurement of the fundamental frequency of an oscillator was pointed out. There may be cases in which it is desirable to have an indication of the harmonic content of a radio-frequency

★ **Brightest Star**
in the Audio
 ★ **Oscillator Field**



Model 652

Here is a tried, proven and accepted Audio Oscillator whose brilliant performance sets it apart from other makes. Success is due to a basic new principle of operation. Audio Frequency voltage is developed at its Fundamental Frequency. This is not a "beat frequency" oscillator and contains no R.F. circuits. Operation is vastly simplified. Characteristic faults of old style methods are eliminated. Model 652 is accurate to within 3%, or one cycle. Many outstanding features. Price \$69.50.

Write for descriptive literature

**THE JACKSON ELECTRICAL
 INSTRUMENT COMPANY**

123 Wayne Avenue Dayton, Ohio

Duotone
 CUTTING and PLAYBACK
NEEDLES

to the most critical ear . . .

WE RECOMMEND

STEEL CUTTING NEEDLE
List 25c

Will cut from 15 to 25 ten-inch records with a very minimum of surface noise, retaining the fidelity of the original sound. In constant use wherever tested. 100 individually enveloped needles to a carton (list \$25.00). Write for a sample and try this fine cutting stylus on your ears!

ALSO — Professional sound men endorse the performance of DUOTONE Sapphire Cutters, with brass or dural shanks.

Write for Descriptive Literature

DUOTONE COMPANY, Inc.
 799 Broadway • New York City

wave, or an idea of the relative power of the lower harmonics. The instrument described responds to as high as the eighth harmonic with the generator used, which is convenient in its calibration or in checking. Such response is presumably limited by the harmonic content of the output of the generator. At such distances from the generator that the usual type of frequency meter gives little indication, this instrument will give a large indication. This means that the frequency of a small oscillator such as employed in the radio sonde¹⁰ can readily be measured with sufficient deflection to obtain an accurate measurement.

Measurements were made on coil 1 at 31 and 62 megacycles per second which show the precision of measurement possible with this instrument. Taking full scale deflection (20 divisions) for resonance, a three-fourths scale deflection was obtained with a movement of the condenser of 0.2 divisions. As the average change in megacycles per division change for coil 1 is 0.16 megacycles per second a change to three-fourths the maximum deflection represented a change of 0.032 megacycles per second. It is possible to show smaller changes from maximum deflection than given in the example cited. The use of a vernier scale would enable the condenser scale to be read precisely to 0.1 division which would give measurements to 16 kilocycles per second, or a precision of from 0.03 to 0.05 per cent, depending on the frequency.

REFERENCES

- ¹A method of using fractional harmonics of quartz crystals. J. H. Barron, Jr. *Radio Service Bulletin*, No. 129, 7, Dec. 31, 1927.
- ²Application of the Cymometer. J. A. Fleming. *Proc. Phys. Soc.* 19, 603, 1905.
- ³The Principles of Electric Wave Telegraphy and Telephony." J. A. Fleming, Longmans, Green and Co., London, p. 425, 4th edition, 1919.
- ⁴A compact sensitive wavemeter. B. W. Brown. *Rev. of Sci. Inst.*, 10, 196, June 1939.
- ⁵A high-frequency wavemeter. H. R. Meahl. *Gen. Elec. Rev.*, 42, 279, June 1939.
- ⁶Direct-reading wavemeter for ultra-high frequencies. E. Karplus. *Gen. Radio Experimenter* 15, 1, Aug. 1940.
- ⁷Standard radio wavemeter, Bureau of Standards Type R-70B. R. T. Cox. *Jour. Optical Soc. of America* 6, 162-168, March 1922. *Radio Topics* 1, 6, Jan. 1922.
- ⁸The standard wavemeters of the Bureau of Standards. E. L. Hall. *Sibley Jour. of Engineering* (Ithaca, N. Y.) 38, 123-126 (1924). *Popular Radio* 6, 173-177, Aug. (1924).
- ⁹Method and apparatus used in testing piezo oscillators for broadcasting stations. E. L. Hall, *BS J. Research* 4, 115-130, Jan. (1930). *Proc. I.R.E.* 18, 490-509 (1930).
- ¹⁰Upper-air Weather Soundings by Radio. H. Diamond, W. S. Hinman, Jr., F. W. Dunmore and E. G. Lapham, *A.I.E.E. Trans.* 59, 321-328 (1940).

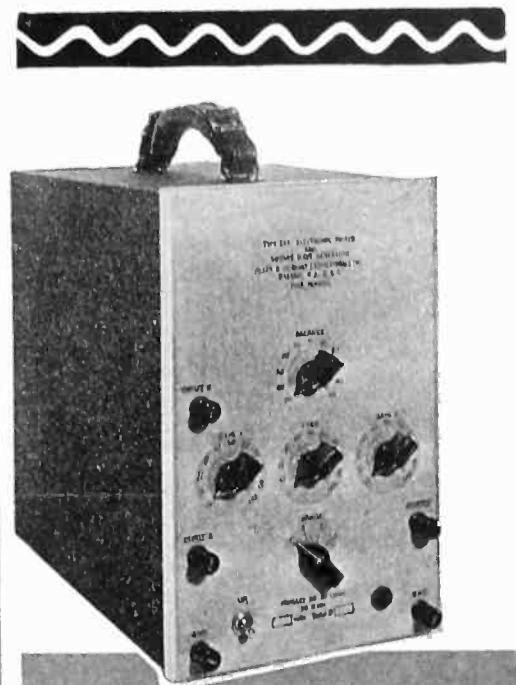

Simplified
**MONITORING OF
 MODULATION %**

★ Monitoring the modulation percentage of radio transmitters at remote locations has always involved rather elaborate equipment, difficult to adjust and operate, and calling for a specially-modified radio receiver.



Such complications can now be minimized through the use of the DuMont Type 185 Electronic Switch. Any good superheterodyne radio receiver having a linear diode detector and covering the prescribed tuning range, can be used to pick up the signal. No modification of the receiver's circuits is necessary. No radio-frequency connections need be made to the cathode-ray oscillograph. Any good cathode-ray oscillograph having uniform audio-frequency response, may be used as the indicating medium.



This simplification of modulation study at remote locations may be the answer to some of your transmitter-performance problems. It is described in the *DuMont Oscillographer*, Vol. 3 No. 6, which is yours for the asking.

DU MONT

**ALLEN B. DU MONT
 LABORATORIES, Inc.**

Passaic ★ New Jersey

Cable Address: Wespexlin, New York

THE INDUSTRY IN REVIEW

News

♦ As of April 1st the N.T.S.C. has become the National Television System Committee of the R.M.A. Engineering Department and will continue to concern itself with the continuing problems of standardization in television broadcasting Ray Wilson, who was formerly with Zenith Radio Corp. is now associated with the Radex Corporation of Chicago The Telechordon Laboratories, 141 Charles St., New York City, a newly formed organization, will shortly enter the television receiver manufacturing field. . . . The Plastics Division of Erie Resistor Corporation, Erie, Pa. have expanded their molding facilities and are now producing extruded plastics.

♦ An immediate start on construction of 101 buildings to house signal communications schools in thirty-nine Army Corps, division and anti-aircraft firing centers in all parts of the country was authorized by the War Department. Estimated cost of the project will be \$904,085. . . . The American Cyanamid Company has changed the name of its Beetle Products Division to Plastics Division. C. J. Romieux is sales manager of the division, in charge of commercial activities, and Dr. K. E. Ripper as chief technologist, heads its technical activities. . . . Reese F. Clifford has been appointed personnel director of the Western Electric Company, New York City. . . . The Cornell-Dubilier Electric Corp. has announced the purchase of the plant of the Kendall Co. at New Bedford, Mass. The plant at South Plainfield, N. J. will continue as heretofore . . . George Lewis, vice-president of the International Telephone Development Co., Inc., a subsidiary of the International Telephone & Telegraph Corp., announces the doubling of its space at its plant at 137 Varick St., New York for the production of selenium rectifiers . . . Westinghouse Electric & Mfg. Co., announces that they will construct a \$3,000,000 factory for the production of fluorescent lamps at Fairmont, W. Va. The new plant will be windowless and adapted for complete blackout in any emergency. Operation is scheduled to begin in July.

♦ The approval of a commercial frequency modulation station for New York City and surrounding territory was announced by the Federal Communications Commission in granting a permit to Major Edwin H. Armstrong, for the station at Alpine, N. J., which operated for almost two years under the experimental call letters of

W2XMN. The new commercial station at Alpine has not yet been assigned call letters, but will operate on a channel of 43.1 megacycles and cover a service area of 15,610 square miles. It has been authorized by Washington as Class D, and thereby has almost twice the coverage area granted to New York City frequency modulation stations designated as Class B. Some 12,200,000 persons live within listening range of the Armstrong station. . . . Columbia Broadcasting System is seeking a frequency modulation outlet in Hollywood. This is the fourth frequency modulation transmitter proposed by Columbia Broadcasting System. Two of them at New York and Chicago have been given the Communications Commission approval. A third is pending for Boston.

♦ Station W45V (Evansville, Illinois) is starting the operation of its new ten-kilowatt frequency modulated broadcast transmitter. A construction permit has been granted by the Federal Communications Commission for operation on 44.5 megacycles to cover an area of 8,397 square miles and to serve a population of 465,000. . . . Royal J. Higgins has been appointed director of advertising and sales promotion for Hallcrafters. . . . The University of Georgia announced the first winners of the George Foster Peabody Awards for outstanding public service in the field of radio during 1940. The awards, comparable to the Pulitzer prizes in the field of journalism, went to the Columbia Broadcasting System among chains; station WLW, Cincinnati, Ohio, among large stations; station WGAR, Cleveland, Ohio, among regional stations; station KFRU, Columbia, Mo. among small stations, and to Station WGEO of Schenectady for its service to the United States Antarctic Service expedition.

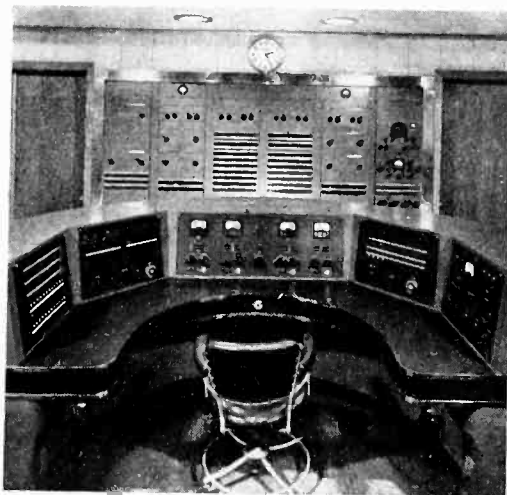

The new master control desk at Station WLS in Chicago

♦ Sprague Specialties Company and Sprague Products Company of North Adams, Mass., are turning over their Brown Street factory to defense orders. . . . A building program which will exceed \$100,000 for the construction work alone and will more than double the present capacity of the Superior Tube Company's plant has been launched at Collegeville, Pa. . . . The United States Engineering Defense Training program has instituted classes in production engineering and production supervision, engineering and mechanical drawing, and metallurgy and heat treatment in Collegeville at which employees of the Superior Tube Company are now receiving training in evening classes. The courses are sponsored by the University of Pennsylvania in connection with the United States defense training of employees.

♦ Gerald C. Gross is now assistant chief engineer and chief of the broadcast division engineering department of the Federal Communications Commission. Mr. Gross succeeds Andrew D. Ring who has resigned. George P. Adair was named assistant chief of the engineering department broadcast division. Philip F. Siling was appointed chief of the international division, engineering department, succeeding Mr. Gross. Mr. Gross participated in the formation of the engineering division of the Federal Radio Commission in 1928 and for some time past has served as chief of the international division of the present Commission's engineering department. He has represented the government at 21 international conferences on communications, and has served since 1933 as Secretary of the Interdepartment Radio Advisory Committee.

♦ Harold G. Beebe has joined the staff of the industrial division of the International Resistance Company, Philadelphia, Pa. Mr. Beebe will devote his efforts to industrial and government users of resistance devices. . . . Robert E. Shelby has been appointed development engineer of the National Broadcasting Company. Mr. Shelby succeeds R. M. Morris who recently joined the company's radio-recording division. . . . The appointment of J. Leonard Reinsch as director of the Cox radio stations (WSB, Atlanta; WHIO, Dayton; and WIOD, Miami) was announced by J. M. Cox, Jr. Each station will continue to operate as a separate organization with James Le Gate as general manager in Dayton and Arch Robb as general manager of the Miami station. Mr. Reinsch will make his headquarters in Atlanta.

Literature

Transmitting and Special Purpose Tubes. Form TT-100 is a new 16-page booklet on transmitting and special purpose tubes available from RCA Manufacturing Co., Camden, N. J. This booklet catalogs all RCA transmitting tubes, transmitting rectifiers, television tubes, oscillograph tubes, phototubes, acorn tubes, gas tubes, voltage regulators, and special amplifier tubes.

House Organ. Air Associates, Inc., Bendix, N. J. recently released Vol. 1, No. 1 of their new house organ *Air Associates News*. This bulletin announces that Air Associates is producing a complete line of radio communicating systems. Some of this equipment is illustrated and thoroughly described. One full page of this eight page issue is devoted to ultra-high frequency radio units.

Transmitter Maintenance. The March, 1941 issue of *The General Radio Experimenter* contains an article "Transmitter Maintenance in the Modern Broadcasting Station," by Charles Singer, technical supervisor of Station WOR. Another article contained in this issue is "Calibrating Three-Phase Power-Factor Meters with the Variac."

Precise Audio Frequencies. The December 1940 issue of *Research Worker*, a publication of Aerovox Corp., New Bedford, Mass, contains an article by their engineering department entitled "Obtaining Precise Audio Frequencies."

Single-Sweep Stopwatch. The *DuMont Oscillographer* issue of February-March, 1941, contains an abstract of a paper by Alexander Sandow of the Department of Biology, New York University on the subject of "A Single-Sweep Stopwatch and Its Use in a Biological Department."

1941 Catalog. The American Television and Radio Co., 300 East Fourth St., St. Paul, Minn., announces the release of their 1941 catalog No. 141 which covers their complete line of vibrator-operated and rectifier power supplies including direct current and alternating current inverters "A" battery eliminators, battery chargers, etc.

Component Bulletin. The Crowe Name Plate & Manufacturing Company, 3701 Ravenswood Avenue, Chicago, have issued Bulletin No. 242 which covers items for jobbers and manufacturers in radio components. It includes precision tuning devices, plates of all sorts for transmitters, radio receivers, phonographs, etc., in different metals and finishes. Also illustrated and described are knobs in Bakelite and Tenite for instruments, transmitter panels, etc.

• When you want

TRANSFORMERS

only Ferranti
offers you ALL this:

- **EXPERIENCE** . . . 60 years Engineering Experience.
- **RESPONSIBILITY** . . . Unmatched prestige in the Electrical Industry.
- **ENGINEERING** . . . An experienced Staff at your disposal.
- **EQUIPMENT** . . . Equal to any requirement of modern precision production.
- **DELIVERIES** . . . not just promises.
- **ECONOMY** . . . The Economy inherent in first-class products, far offsetting any "savings" in initial expense.



Ferranti

**ELECTRIC
INCORPORATED**

R. C. A. BUILDING, NEW YORK, N. Y.

FERRANTI PRODUCTS

Transformers for every electronic, sound, communication, industrial, and laboratory use — miniature aero transformers for aircraft and portable work — high power plate and filament transformers — filters, equalizers, modulation sets, rectifiers, etc. — electrostatic voltmeters, portable voltmeters, ammeters, phase rotation indicators, special testing equipment, and numerous other instruments.

WORLD'S GREATEST all around ELECTRIC TOOL

DRILLS — GRINDS — SANDS

SAWS — POLISHES

SHARPENS — CARVES



**ONLY
\$7.95
POSTPAID
GUARANTEED
FOR ONE YEAR**

The new **WHIZ ELECTRIC TOOL** is the handiest power tool ever made. A rugged tool for power and precision work. Drills through 1/4 inch iron plate in 42 seconds or engraves intricate designs. Handles any material: Metals—Woods—Alloys—Plastics—Glass—Steel—etc. Saves time. Eliminates labor. Plug into any socket AC or DC, 110 volts. Chuck 1/4 inch capacity. Ball bearing thrust. Powerful, triple-gear motor. **STANDARD MODEL**, with Normal Speed (uses 200 different accessories, instantly interchangeable). Price only \$7.95.

The only DRILL-TOOL with a full year's guarantee.

FREE Accessory outfit (Value \$2) includes set of drills, mounted 1 1/2 inch grinder, sanding discs, cutting wheels, mounted brush, polishing wheel, carving burr, etc. **FREE** with each tool ordered **NOW**. We pay postage.

10 Day Trial—Money Back Guarantee

PARAMOUNT PRODUCTS CO.

DEPT. 5EL

545 FIFTH AVENUE

NEW YORK, N. Y.

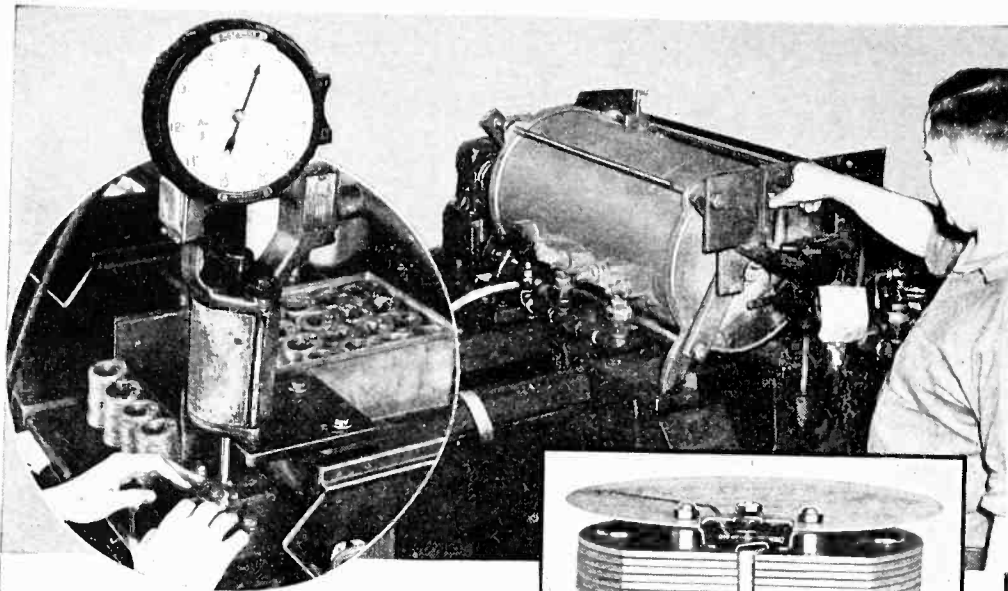

It's got to be right TO BE **TRIPLETT**

In every phase of manufacture, Triplett exercises rigid control over the quality of every part. In instrument manufacture, for example, heat-treating magnets the Triplett way, plus careful ageing, insures permanency. Following heat-treating, processing by special electric hammers insures initial uniformity and freedom against change. Triplett instruments have perfect alignment magnetically and mechanically, with the result that scale readings are linear and free from "curve error." That is why Triplett instruments have been recognized internationally for their precision, long life, and reasonable prices. That is why more and more people are standardizing on Triplett instruments, because they know—"It's got to be RIGHT to be Triplett."

Write for Catalog—Section 235 Harmon Avenue

THE TRIPLETT ELECTRICAL INSTRUMENT COMPANY
Bluffton, Ohio

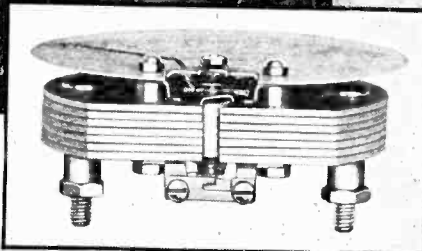

Interior View of D.C. Movement . . . Double truss bridge protects against any vibration—insures permanent perfect alignment of bearing supports, and provides correct scale readings.

THE SOURCE of SATISFACTION for Relays

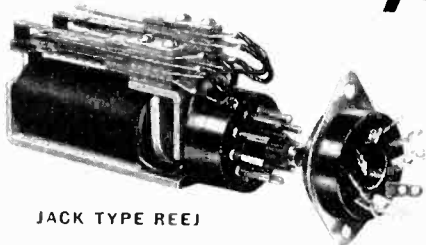

JACK TYPE REEJ

One of several Jack-Type relays in the complete Autocall line. The REEJ has a single low current coil, pivoted armature, contacts positioned and maintained by current, contact return to normal by contact spring tension. For more than 30 years Autocall has specialized exclusively in signalling and control devices and equipment.

Send for Free Catalog

The AUTOCALL Co.
SHELBY, OHIO

Send for
FREE
Catalog

AUTOCALL COMPANY,
Shelby, Ohio
Without obligation, please
send me a copy of your new
No. R-1 catalog on signalling,
control devices and equipment.

Name
Address
City State R-1

NEW EICOR ROTARY CONVERTER



**Convert D.C. to A.C. with Highest
Efficiency and Dependability . . .**

Compact! Sturdy! Quiet! Long life!
Available for operation on any DC voltage—and have standard AC output.
With or without filter. All-equipped
with ball bearings. Write for data!

EICOR, 1050 Adams St., Chicago, U.S.A.
Export: AD Auriema, 89 Broad St., New York

EICOR
Dynamotors • Power Plants • Converters

Broadcast Modernization Data. The Gates American Corporation, Quincy, Ill., has available for broadcasting stations interested in equipment modernization a new booklet which compiled complete cost data, Federal Communications Commission data for filing, illustrations of installations and helpful hints in putting a new station on the air.

1941 Capacitor Manual. The 1941 "Capacitor Manual for Radio Servicing" is now available from Cornell-Dubilier Electric Corporation, South Plainfield, N. J. The book contains 300 pages of complete and precise data pertaining to capacitor replacements in standard receiver models. It includes all the models brought out last year and information on models yet to be brought out.

Aircraft Tubing Data. A 63-page loose-leaf catalog devoted to the subject of aircraft tubing data is available for \$1.50 from Summerill Tubing Co., Bridgeport, Montgomery County, Pa. John E. Younger of the University of Maryland was the consulting editor for the compilation of this data book.

Wire-Wound Resistors. A file catalog is devoted to a description of wire-wound resistors available from Instrument Resistors, Inc., Little Falls, N. J. It also contains a table of continuous working currents and voltages. The various resistors are illustrated and technical data is included.

General Catalog. The Spring-Summer 1941 catalog of general radio equipment is now available from Allied Radio Corp., 833 W. Jackson Blvd., Chicago, Ill.

House Organ. The *Circuit* is devoted to several philosophical articles and also includes a little advertising. It is published by the William Brand & Co., 276 Fourth Ave., New York.

Public Address Guide. New 1941 Atlas Sound Catalog F-41 just released by the Atlas Sound Corporation, 1449 39th Street, Brooklyn, N. Y., describes more than 100 types of public address speakers, microphone stands, connectors, and accessories.

Prestite. Intricate porcelain shapes for high voltage applications are described in Descriptive Data No. 39-600 available from Department 7-N-20, Westinghouse Electric & Mfg. Co., East Pittsburgh, Pa. Di-electric and mechanical strength, heat shock resistance, and dimensional fidelity of Prestite are discussed and compared to wet and dry process porcelain. Applications are listed, and photomicrographs illustrate the texture of Prestite.

B-L Metallic RECTIFIERS Backed by Years of FIELD EXPERIENCE

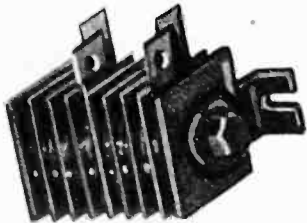

B-L engineers have been manufacturing and supplying B-L Metallic Rectifiers for all

industrial applications for more than twenty years.

Every B-L Rectifier is built to exact specifications—is compact, rugged and dependable.

To insure noiseless, trouble-free A. C. to D. C. current change, use reliable B-L Rectifiers. They have no moving parts to wear out and are economical in first cost—efficient in operation.



Write or wire today for complete information.

THE BENWOOD LINZE CO.

1805 LOCUST ST.
ST. LOUIS, MO.

MANUFACTURERS

ENGINEERS

—MICO— ENGRAVER

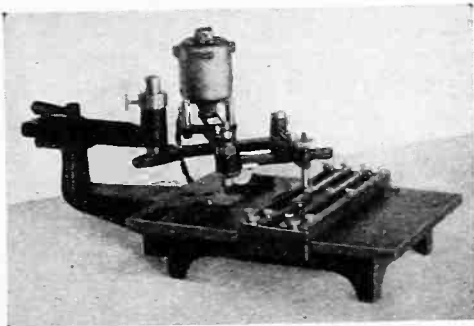

For lettering panels of steel, aluminum, brass, or bakelite, or for marking finished apparatus.

A sturdy machine for routing production as well as occasional engraving.

Attachments increase its versatility to include large work on flat or curved surfaces.

Excellent engraving can be produced by an inexperienced operator.

Catalogue on request.

Prompt Delivery

Priced from \$115 with type.

Mico Instrument Co.
20 ARROW STREET
CAMBRIDGE, MASS.

New Products

Constant Groove Speed Recording Equipment

BULLETINS 141A TO 145A, recently published by Frank Rieber, Inc., 11916 West Pico Boulevard, Los Angeles, describe a new system of recording (known as the CGS Recorder) on paper-thin discs, made of flexible, transparent plastic material. Recording is by a newly developed, slow, constant groove speed, embossing method which presses the groove into the record blank by means of a smooth stylus, instead of the conventional cutting methods. There are no shavings, no wear on the embossing stylus. The signal-to-noise ratio is satisfactory. Operating at constant linear groove velocity, the same number of inches of groove passes under the stylus in any one second, regardless of whether the stylus is at the outside or near the center of the record and, consequently, the quality of the recording and distribution of recorded frequencies is the same for all parts of the record.

When operating at slow constant speed, the maximum playing time can be compressed into a given record space. For example, 7.7 inches per second groove speed provides 31 minutes of continuous recording, and 3.85 inches per second provides 62 minutes per side on a standard 12-inch CGS record. Record blanks are available on a quantity price schedule, which makes it possible to make routine reference recordings at an operating cost as low as 10 cents per hour. Relay rack models are suitable for intermittent or continuous recording, with or without concurrent playback. Interlocked unit assemblies make it possible to record two, three or four hours continuously, without changing a record. The CGS portable recorder, with complete recording and playback facilities, weighs 55 pounds.

Correction

IN THE APRIL ISSUE the editors described a photoelectric volt-ohmmeter (model 661) available from Radio City Products, 88 Park Place, New York City. That was in error. The device described as a photoelectric device is actually an electronic tube volt-ohmmeter.

Non-aluminum Recording Blank

MIRROR RECORD CORPORATION, 58 West 25th Street, New York City, announces a two-sided record blank on a non-aluminum base. These discs are available from 8 inches to 16 inches, and are scientifically coated on a tough, lightweight fibrous base. They are intended for use in libraries, air checks, tests, auditions, etc.

BAKELITE-CASE Mica CAPACITORS

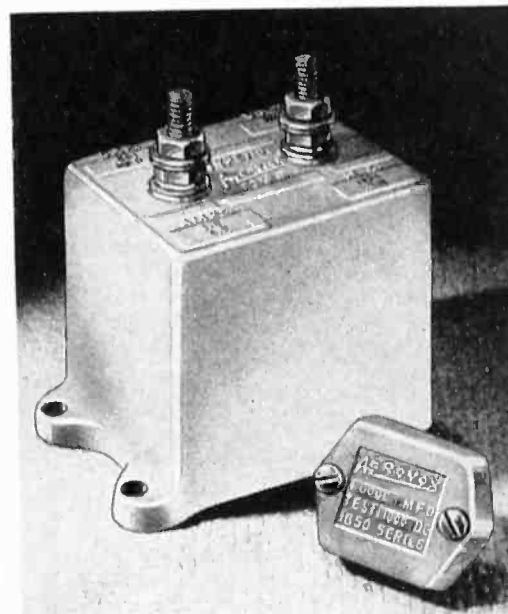

• In both the bakelite-case and the molded-in-bakelite types, Aerovox offers a wide choice of mica capacitors for transmitting and allied purposes. These are standard items, available for prompt delivery, at relatively low cost.

BAKELITE-CASE UNITS

Medium-duty transmitting capacitors for greater load-carrying capacity than molded-in-bakelite types. Backed by data—the accumulation of years of research and experience—indicating maximum current-carrying ratings at five different frequencies, in addition to capacity and test voltage rating. Unit best suited for given current at given voltage may be selected quickly and precisely. Ruby mica and foil sections non-magnetically clamped. Vacuum-impregnated. Low-loss filler and one-piece bakelite case for moisture-proof protection. In standard brown bakelite and in low-loss (yellow) XM bakelite. 250 to 8000 v. test. .00001 to 1 mfd.

MOLDED-IN-BAKELITE

Small high-voltage mica capacitors for transmitting purposes, power amplifiers, electronic assemblies, laboratory equipment, etc. Non-magnetic metal parts reduce r.f. losses to minimum. Heavy terminals for minimum contact resistance. In several different designs, terminals, mountings; with meter-mounting brackets; with ceramic mounting insulators, etc. In standard brown and in low-loss (yellow) XM bakelite. 1000 to 10,000 v. test. .000001 to .05 mfd.

BUILT TO YOUR NEEDS

Most likely you will find a standard item applicable to your needs. But if not, Aerovox can make a special type to meet unusual requirements. Write for data. Submit your problem.



IN CANADA: AEROVOX CANADA, Limited Hamilton, Ont.

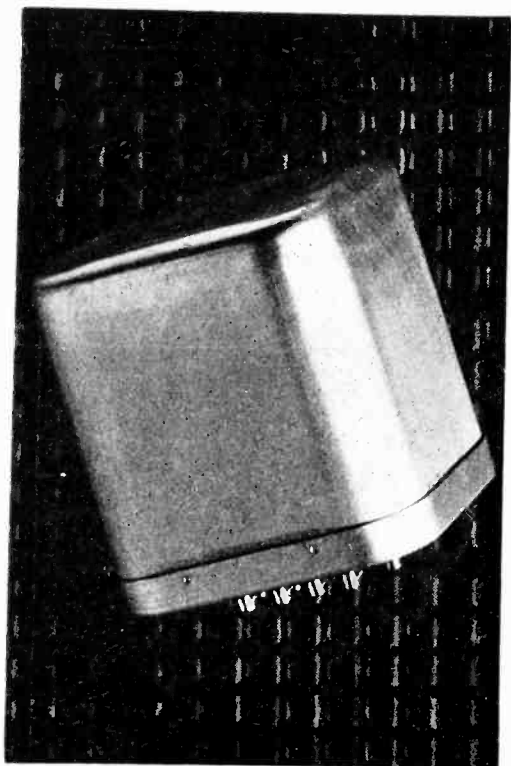

ELECTRIC Wave Filters

The high quality and careful craftsmanship of all Kenyon Products are truly reflected in these Kenyon Electric Wave Filters.

Today wave filters play an important part in the National Defense Program. They are required to perform unseen though delicate and vital functions in all types of communication equipment. They must be made to exacting and rigid specifications so that their performance is unflinching even under the most adverse conditions.

That Kenyon wave filters meet all Army and Navy requirements is no accident. Only the long years of experience of Kenyon engineers in the design of filters and transformers exclusively makes such uniformly high quality possible.

The same experience and knowledge upon which the Army and Navy depends is at your disposal in the solution of your filter or transformer problems.

General Catalog Free on request.

KENYON TRANSFORMER CO., INC.

840 Barry Street New York, N. Y.

Mercury Rectifier Tube

UNITED ELECTRONICS COMPANY, 42 Spring Street, Newark, N. J. announce a new mercury rectifier tube Z-225. The new tube has the same ratings as types 866 and 866-A but occupies less than half the cubic space and gives

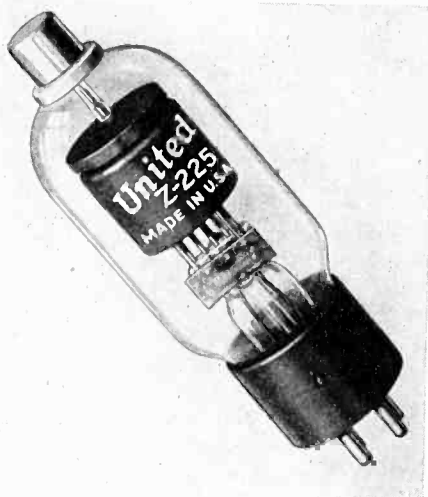

more efficiency per cubic inch of the power supply. The bulb type is T-14, over-all height is 5½ inches, and the diameter is 1¾ inches.

Signal Generator

RADEX CORPORATION, 1733 Milwaukee Avenue, Chicago, Ill. announce a universal signal generator known as "Pocketracer" designed for all types of trouble shooting. It is a radio frequency and audio signal source of the multivibrator type, and is useful for quick analysis of circuit difficulties. The unit generates a universal frequency which can be used for alignment or test purposes. It also gener-



ates an audio frequency as well as radio frequency and intermediate frequency. Total current consumption is 150 milliamperes. The generator uses a single penlite type flashlight battery.

Phenolic Molding Compound

A NEW GENERAL-PURPOSE phenolic molding compound (known as Durez 775 Black) is announced by Durez Plastics and Chemicals, Incorporated, Walek Road, North Tonawanda, N. Y. It was developed to make available a material which would have a wider range of application than existing general-purpose materials. Among the improvements are lower water absorption, slightly higher flexural and tensile strength, heat resistance of 400 degrees F. The new compound has good molding characteristics, fast cure, and will deliver a smooth, lustrous finish.

PROFESSIONAL SERVICES

(Rates on Application)

JOHN C. BATCHELOR

Studies of inventions submitted for financing or production.

100 E. 42nd Street New York City

DUDLEY B. CLARK

Consulting Engineer

Industrial Tube and Circuit Design.
Electronics as applied to Metal and Chemical Industries.

Research Laboratories and Shops
Palm Springs Calif.

ELECTRICAL TESTING LABORATORIES

Characteristics of Vacuum Tubes
Tests of photo cells, glow lamps, crater lamps,
Tests of electronics and optical devices
East End Avenue and 79th Street
New York, N. Y.
Phone: Butterfield 8-2600

HAROLD J. McCREARY

Mem. A.I.E.E. & W.S.E.

Consulting Engineer

Laboratory Facilities
Research Development Design Factory Practise Patent Studies
Electronics Television Radio Railroad Signaling Telephony
105 W. Adams St. Phone STate 4903 Chicago, Ill.

JOSEPH RAZEK, PH.D.

Consulting Physicist

Electrical and Mechanical Engineering Problems
Instruments and Control Devices Electronics
Specialist in Colorimetry, Spectrophotometry and Industrial Color Control

Laboratory and Shop Facilities
430 Greenview Lane Lanerch, Pa.

F. H. SHEPARD, JR.

**CONSULTING ENGINEER
ELECTRONIC APPLICATIONS**

Specializing In:
Industrial Control Special Amplifier Design
Follow-Up Devices Photoelectric Applications
Radio and Carrier Operated Remote Control
6167 Cedar Ave., Merchantville, N. J.
Telephone Merchantville 1111

GILBERT SMILEY

Consultant

Industrial Electric Controls
Photronic and Electronic Devices
Communication, Signal and Alarm Systems
Precision Production Gauges and Counters
197 Sidney Street Cambridge, Mass.
Phone Kirkland 3910

Professional Assistance

in solving your most difficult problems in the specialized field of electronic devices is offered by consultants whose cards appear on this page.

Plug-In Electrolytic Condensers

A PLUG-IN ELECTROLYTIC condenser equipped with an octal base which fits into the standard octal socket is now listed as standard equipment by the Aerovox Corp., New Bedford, Mass. These units are readily removable for substitution, testing and checking and replacement in the same manner and ease as regular radio tubes. These condensers are available in a number of capacities in single, double and triple section units.

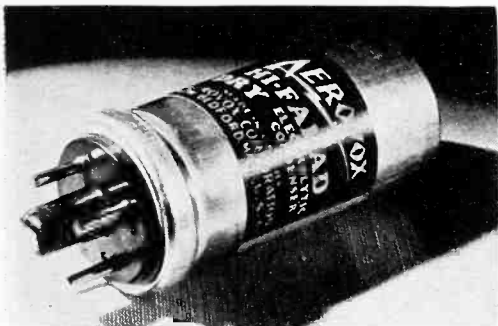

Aerovox Corp., is also featuring a simplified mounting for transmitting condensers. The new mounting procedure consists of drilling two holes large enough to take the pillar terminals of the new condenser and to drill two smaller holes to take the bolts that hold the mounting ring. When mounted the condenser makes a neat job and all high voltage wires are kept below the chassis.

Loudspeaker Cabinet

A NEW LINE OF ACOUSTIC enclosures for use in corner mounting, sidewall hanging and cluster arrangement in groups of two, three and four is announced by the Atlas Sound Corp., 1443-39th St., Brooklyn, N. Y. These cabinets

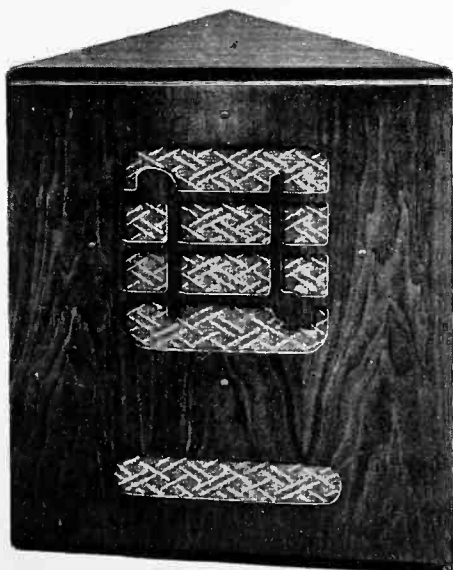

provide an infinite baffle with a bass reflex design. They are finished in a natural walnut grain and have an acousti-cloth grille. Model TR-12 for all 12-inch cones has an overall height of 22 inches, a width of 19 inches, and a depth of 10 inches.

NEW DESIGN LEADS INDUSTRY!

**GOAT FORM-FIT SHIELDS
"1330" SERIES
for GT/G—GT—Loktal Tubes**



Maintaining a leadership held for many years in the industry, Goat engineers have developed the new, Form-Fit Tube Shield for GT/G, GT and Loktal tubes. New, improved design with smooth, solid drawn wall makes the Goat Form-Fit shield more efficient . . . more compact . . . better looking. Snug, positive fit is assured. Automatically grounds to base of tube. Assembly is easier . . . quicker. For more economical shielding, write today for samples and prices.

New "1330 Series" Bulletin will be mailed on request



GOAT METAL STAMPINGS, Inc. DIVISION FRED GOAT CO. EST. 1893
314 DEAN STREET, BROOKLYN, N. Y.

TAYLOR
LAMINATED PLASTICS
Vulcanized Fibre • Phenol Fibre
SHEETS, RODS, TUBES, FABRICATED PARTS
TAYLOR FIBRE COMPANY
Norristown, Pennsylvania



"Mangrid"
GRID WIRE
Economy with Quality

WILBUR B. DRIVER CO.
NEWARK, NEW JERSEY



90% of a SURVEYED GROUP of ELECTRONICS READERS said . . .

Yes . . .

WE WANT
IT!

TO: Keith Henney
re: value of a Directory Issue of Electronics

I WOULD find use for such a directory of Manufacturers *definitely*
I WOULD NOT find use for such a . . .

In the past, when in need for a directory of manufacturers
I have always referred to (. . .)
names of magazines (. . .)
or books (. . .)

I suggest the following groups of products or materials
should be included in your directory: *None Available*

TO: Keith Henney
re: value of a Directory Issue of Electronics

I WOULD find use for such a directory of Manufacturers *X!*
I WOULD NOT find use for such a . . .

In the past, when in need for a directory of manufacturers
I have always referred to (. . .)
names of magazines (. . .)
or books (. . .)

I suggest the following groups of products or materials
should be included in your directory: *None Available X*

You have listed the most important

I suggest the following groups of products or materials
should be included in your directory: *X*

*Metallurgical Research and Forming
Electrical Research and Design
Scientific Instrument Staff. General Tool & Trench*

So THEY GET IT—IN JUNE— a valuable Buyer's Reference & Engineer's Reference

Of the hundreds of subscribers who answered our questionnaire, nearly 90% were very much for a directory issue, as typified by the cards above. So we are preparing the first complete directory ever compiled for the electronic and allied fields.

A COMPLETE Buyer's Reference covering all manufacturers of Radio Receiving, Transmitting and Industrial Components, Circuit Assemblies . . . Raw and Fabricated Materials . . . Transmitting, Receiving and Industrial Tubes . . . Electrical Measuring Equipment . . . Broadcast and Radio Assemblies . . . Industrial Electronic Control Equipment and Machinery . . . Public Address and Sound Equipment . . . Electronic Medical Apparatus . . . Engineer's Supplies . . . Services . . . Schools . . . Etc., Etc.

The ELECTRONICS subscriber will have a com-

plete source index at his elbow for a year.

Though we did not indicate so in our questionnaire, we are giving the subscribers a double value, in pages upon pages of up-to-the-second formulary and data.

Nine sections of charts, tables, listings, formulas and equations to answer current engineering problems on:

1. Industrial Applications of Tubes.
2. Standard Broadcasting Transmission and Reception.
3. Frequency Modulation Broadcasting and Reception.
4. Television Broadcasting, Transmission and Reception.
5. Audio Circuits and Sound Equipment.
6. Measuring Methods.
7. Ultrahigh Frequency Technique.
8. Communication Systems.
9. Vacuum Tube Data.

Nothing to contribute to the progress of electronic engineering has been done like this before.

And Advertisers' Acceptance was **IMMEDIATE**

Upon Announcement

of this

GREATEST

VALUE

for Reader & Advertiser

EVER PRESENTED BY THIS MAGAZINE



Upon announcement a month ago of this First Annual Reference and Directory Issue, to be published in June, reaction was immediate and universally favorable. It was realized that we were preparing a comprehensive contribution to our industry of special value at this time of emergency.

Here are the multiple advantages offered to any advertiser making products used in the electronic, industrial control, and feeble-current fields:

1. *Long life.* An issue retained for its immediate product-source information PLUS a virtual handbook of modern electronic engineering practice.
2. *Timeliness.* This is mid-season for a majority of

the subscriber-engineers.

3. *Tradition.* The June issue has always rendered an extended editorial service.
4. *Quick Sales Approach.* Your name is in bold face in the Directory and is keyed to the page of your advertisement — a quick sales approach at the time your prospect needs your product.
5. Distribution at the Radio Parts National Trade Show in Chicago, where the key men of radio and communication gather.

We do not believe that ELECTRONICS has ever presented such an advertising value at regular space rates.

THE CLOSING DATE IS NECESSARILY EARLY

Our cross-indexing of advertisers is a big job and requires more time

FINAL CLOSING DATES . . . Plates May 26, Copy to set May 22

ABC **electronics** ABP

A McGraw-Hill Publication • 330 W. 42nd St., New York, N. Y.

ADD ELECTRONICS TO YOUR SALES STAFF

Precisely Calibrated

Specially designed for manufacturers and users of electrical measuring instruments, electrical and radio testing equipment and other high-grade electrical apparatus.

SHALLCROSS



"Akra-Ohm" Resistors are available in a wide variety of types and forms, and special types can be furnished. Moisture-proof — they hold their calibrations.

"AKRA-OHM"



Resistors can be furnished with an accuracy of 1%, .5%, .25% and .01%; ranging from 1 to 10,000,000 ohms. Normal accuracy is $\pm 1\%$.

RESISTORS

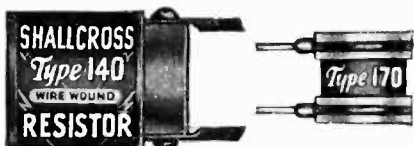

bearing the Shallcross name are of uniformly high quality and superior performance. Standard instruments can be supplied for any combination of resistances desired.

Write

for Bulletins No. 122 and 825KP

SHALLCROSS MFG. CO.
Instruments — Resistors — Switches
COLLINGDALE, PA.

Cathode Ray Tube

A NEW HIGH-VACUUM cathode-ray tube for use in oscillographs where low deflection-plate capacitances are essential is announced by Allen B. Du Mont Laboratories, Inc., 2 Main Ave., Passaic, N. J. The new tube is available with four different screen phosphors and the series is designated as the type 2529. The deflection-plate leads are short and direct, terminating in caps on the glass walls of the tube. The intensifier electrode makes use of acceleration of the electron beam after deflection to increase deflection sensitivity. Use of the intensifier electrode makes for economy in deflection voltage and modulation voltage amplifiers and in the power supply. The phosphors available are Du Mont types A, a medium persistence green; B, a long-persistence green; C, a highly-actinic short-persistence blue, and D, a medium-persistence white.

Resistance Standards

SHALLCROSS MANUFACTURING COMPANY, Collingdale, Pa., announced No. 800 Series resistance standards which are accurately calibrated resistances from 1 ohm to 10 megohms in single

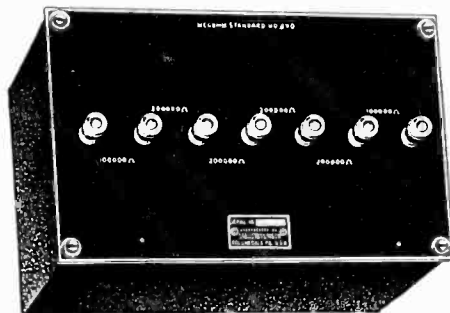

units and in various combinations. They are designed for direct current electrical measurements and alternating current measurements at frequencies up to 20 kilocycles. These resistors were designed for electrical measurements in research engineering, teaching and testing.

Multiple Spot Welder

THE EISLER ENGINEERING Company of 740-770 South 13th Street, Newark, N. J., has recently placed a new type of multiple spot welder on the market. These machines are primarily intended for the spot welding of light sheet metal work where a large range of adjustments for various spots and shapes are to be considered. Adjustments can be made to make circular, straight, square, rectangular or any odd shape welds, to conform with any need. From 2 to 12 spots can be made simultaneously, depending on the nature of the job. Pressure electrodes are used with suitable air operation equipment. The electrodes have an individual adjustment so as to maintain an even pressure on all the spot welds being made.

Prepare to pass RADIO OPERATOR LICENSE EXAMINATIONS

—this direct easy way—

Bring all your radio training, experience, and study before you in quick, direct review—make sure you know key points of all theory and practice as covered in Government examinations. Nearly 1300 questions, with full, correct answers, given in this book, make you confidently familiar with the essentials of all commercial license tests.

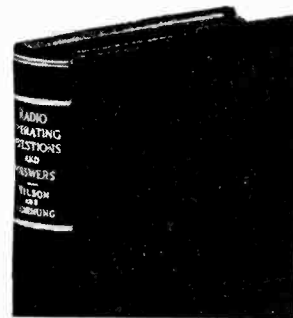

New 7th Edition

RADIO OPERATING QUESTIONS and ANSWERS

By Arthur R. Nilson

Chief Instructor, Nilson Radio School; Lieut. (Technician) (Communications) U.S.N.R. (Retired) and J. L. Hornung

Formerly Radio Instructor, New York University

400 pages, 5 x 7 1/2, illustrated, \$2.50

This is a technical review book on radio communication for prospective and experienced radio operators of all classes, condensing in question and answer form all the information covered in the new type of Government radio operator license examinations. It provides an answer to each question appearing in the FCC Publication, *Study Guide and Reference Material for Commercial Radio Operator License Examinations*, and is arranged according to the six elements upon which examinations for all grades of licenses are now based:

1. Questions on Basic Law
2. Basic Theory and Practice
3. Radiotelephony
4. Advanced Radiotelephony
5. Radiotelegraphy
6. Advanced Radiotelegraphy

Appendix of operating abbreviations, rules governing commercial operators, and radio laws

For twenty years thousands of men have used previous editions of this book with success. Now more than ever this seventh edition helps you get a quick command of all the information needed to pass tests.

Mail this coupon for

10 DAYS' FREE EXAMINATION

McGraw-Hill Book Co., Inc., 330 W. 42nd St., N. Y.

Send me Nilson and Hornung's Radio Operating Questions and Answers for 10 days' examination on approval. In 10 days I will send \$2.50 plus few cents postage, or return book postpaid. (Postage paid on orders accompanied by remittance.)

Name

Address

City and State

Position

Company L-5-41

(Books sent on approval in U. S. and Canada only.)

CONTACTS

FOR THE FIELD OF ELECTRONICS

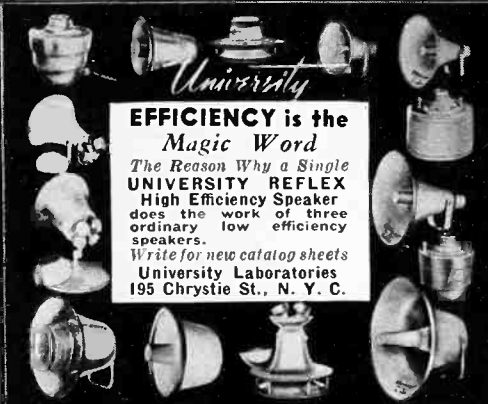

EFFICIENCY is the Magic Word
 The Reason Why a Single UNIVERSITY REFLEX High Efficiency Speaker does the work of three ordinary low efficiency speakers.
 Write for new catalog sheets
 University Laboratories
 195 Chrystie St., N. Y. C.

CRYSTALS by HIPOWER

The Hipower Crystal Company, one of America's oldest and largest manufacturers of precision crystal units, is able to offer the broadcaster and manufacturer attractive prices because of their large production and the exclusive Hipower grinding process. Whatever your crystal need may be, Hipower can supply it. Write today for full information.

HIPOWER CRYSTAL CO.

Sales Division—205 W. Wacker Drive, Chicago
 Factory—2035 Charleston Street, Chicago, Ill.



SIGNAL & INDICATOR PILOT LIGHTS
 for all electrical devices.
 WRITE FOR CATALOGUE showing a complete line of assemblies for all purposes.
SIGNAL INDICATOR Corp.
 140 CEDAR ST. NEW YORK, N. Y.



We manufacture a complete line of equipment
 SPOT WELDERS, electric, from ¼ to 500 KVA AC ARC WELDERS
 TRANSFORMERS, special and standard types WELDERS
 INCANDESCENT LAMP manufacturing equipment From 100 to
 FLUORESCENT TUBE MAKING EQUIPMENT 400 Amps.
 ELECTRONIC EQUIPMENT, vacuum pumps, etc.
 WET GLASS slicing and cutting machines for laboratory use
 GENERAL GLASS working machines and burners
 COLLEGE GLASS working units for students and laboratory
EISLER ENGINEERING COMPANY, CHAS. EISLER, Pres.
 751 So. 13th St. (near Avon Ave.) Newark, New Jersey

WHO DONE IT?

There's no mystery about the long list of happy Terminal customers. We can proudly say, "We done it" with unusual concentration on friendly service, quality merchandise, and straight-from-the-shoulder dealing with our customers, who are our friends, too.

TERMINAL RADIO CORP.
 68 WEST 45TH STREET
 80 CORTLANDT STREET
 NEW YORK CITY

"What Can It Do For Me?"

Advertising that is read with this thought in mind, may provide the solution to a problem that has kept you awake nights for weeks.

Remember, back of the signature of every Electronics advertiser is another organization, whose members have thought long and hard about your business in the course of introducing and applying their products or services to your industry.

If their offerings can improve the quality of your company's product . . . or save your company's money . . . they can contribute to your company's income.

We all know, "It pays to advertise." It pays just as big to investigate what is advertised!

Each month, Electronics advertisers, old and new, invite you and over 14,000 other subscribers to investigate further the advantages they can provide.

Departmental Staff
ELECTRONICS

MICROMETER

for checking transmitters, from 1.5 to 56 mc., within 0.01 per cent.

LAMPKIN LABORATORIES
 —Bradenton, Fla., U. S. A.—



HARVEY has it IN STOCK

Orders for national defense are slowing up deliveries from radio parts manufacturers. For your convenience, HARVEY is ordering "stock" supplies so that you may have the product you want — WHEN you want it!
HAVE YOU A 1941 HARVEY CATALOG?
 Call BRYANT 9-1946 for SERVICE!

HARVEY RADIO CO.
 Conveniently located at Times Square
 103 W. 43 ST. • NEW YORK, N. Y.



Rex Rheostat Co.
 37 WEST 20TH ST NEW YORK, N.Y.
 Send for Catalog

BUILD YOUR OWN WELDER

Get the efficiency and increased production of a high class ARC WELDER at a small fraction of the price . . . BUILD YOUR OWN with our TRANSFORMER, COMPLETE WITH BUILT IN REACTOR . . . 110 volts—\$17.50; 220 volts—\$18.50. . . or, we'll provide you with a complete arc welder 110 volts . . . \$35.00; 220 volts . . . \$36.00
 Welder parts and plans available—write for details!
COTTER THERMO-ELECTRIC CO.,
 Dept. "Y," 15368 Baylis, Detroit, Mich.

FINE RIBBONS of Tungsten and Molybdenum

Molybdenum in widths .006" to 1" in thickness to .0005"
 Tungsten Ribbon to specification
H. CROSS
 15 Beekman St. New York

? Find what you are looking for? ?
 If this or other advertising in this issue does not supply the information of products wanted write
 Electronics
 330 West 42nd St., New York City

New Fountain Pen Size! RF. IF. AF Signal Generator
PEN OSCIL-LITE
 Self powered oscillator for:
 • All alignment
 • Trouble shooting
 • PA systems
 • Checking sensitivity • AVC • Antennas • 10 second locating of auto set ignition pickup
 • Host of other tests. Utterly simpler, faster, more accurate. Used by U.S. Army Signal Corps, hundreds of servicemen and organizations. Write now for leaflet.
GENERAL TEST EQUIPMENT CO 213 E. CROSBY, KENMORE, N. Y.

WIRE & RIBBON

For Direct-Heated
ELECTRON EMITTERS

in VACUUM TUBES

A Complete Range of Sizes
and Alloys for

- ★ TRANSMITTING TUBES
- ★ RECEIVING TUBES
- ★ BATTERY TUBES
- ★ HEARING-AID TUBES

Melted and worked under close
supervision to assure maximum
emissivity, uniformity and the
highest tensile strength

WIRES drawn to .0005" diam.
RIBBON rolled to .0001" diam.

SPECIAL ALLOYS made to meet
individual specifications

Write for list of stock Alloys

SIGMUND COHN

44 Gold St.  New York City

Dual Speed Recorder

SPEAK-O-PHONE RECORDING and Equip-
ment Company, 23 West 60th Street,
New York City, announce a new dual
speed recorder known as model 9MA.
The unit has an easy spring adjust-
ment for cutting-head pressure on dif-
ferent types of discs, and also a cutter
angle adjustment for various types of



needles. The motor is a General Elec-
tric heavy duty, constant speed type
which will operate on 110 volts, 50 to
60 cycles per second. 78 and 33½ rota-
tions per minute are accomplished by
lifting or depressing an idler pulley
attached to a free-wheeling plunger.
The idler pulley is self regulating and
automatically accommodates itself to
increased torque and thereby insures a
constant uniformity of rotation at all
pressures. The recorder has a tangent,
crystal type pickup, and a 12 inch
turntable. The unit may be connected
with any good amplifier or radio for
direct or off the air recording.

Frequency Response Recorder

A NEW DEVELOPMENT of Sound Ap-
paratus Company, 150 West 46th
Street, New York City is a level re-
corder which was designed to make
frequency response curves on all kinds
of electrical acoustical apparatus.
Characteristics of the new recorder
are as follows: sensitivity is approxi-

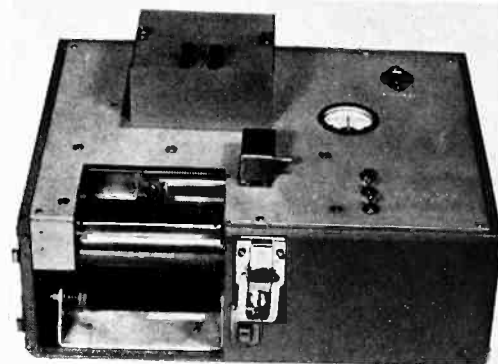

mately 5 millivolts, input impedance
is 10,000 ohms, stylus velocity is 0.2
seconds across a 4-inch recording
chart, paper speed is 4½ inches per
minute (can be changed if desired),
the range is 40 decibels in 200 steps,
each step 0.2 decibel. The ranges are
all interchangeable. Other features of
the recorder include oscillator drive,
paper rewinding mechanism, and inter-
changeable ink writing on a semi-log
paper or a wax covered paper. The
unit weighs 35 pounds and comes in a
portable case measuring 9 inches by
12 by 15 inches.

SEARCHLIGHT SECTION

EMPLOYMENT • BUSINESS • OPPORTUNITIES • EQUIPMENT—USED or RESALE

UNDISPLAYED RATE:

10 cents a word, minimum charge \$2.00.

(See ¶ on box Numbers.)

Positions Wanted (full or part-time salaried
employment only), one-half the above rates.

Proposals, 50 cents a line an insertion.

INFORMATION:

Box Numbers in care of our New York,
Chicago or San Francisco offices count 10
words additional in undisplayed ads.

Discount of 10% if full payment is made in
advance for four consecutive insertions of
undisplayed ads (not including proposals).

DISPLAYED—RATE PER INCH:

The advertising rate is \$6.00 per inch for all
advertising appearing on other than a con-
tract basis. Contract rates quoted on request.

An advertising inch is measured ¾ inch ver-
tically on one column, 3 columns—30 inches
—to a page. E.

NEW ADVERTISEMENTS received by 10 A. M. May 26th will appear in the June issue, subject to limitations of space available.

POSITION VACANT

LARGE MIDWESTERN radio receiver manu-
facturer has openings for experienced auto-
motive and household radio receiver design
engineers. Applicants should state education,
experience and give references. Our own em-
ployees know of this ad. P-270, Electronics, 520
N. Michigan Ave., Chicago, Ill.

POSITIONS WANTED

PHYSICIST, five years Government research-
development experience, electronics expert,
effective writer. Creative instrument and cir-
cuit designer. Desires stable technical or ad-
ministrative position. Reply PW-269, Elec-
tronics 330 W. 42nd St., New York, N. Y.

RADIO-MECHANICAL ENGINEER-DE-
SIGNER, thorough knowledge circuit design,
proven inventive ability, capable improving,
simplifying existing products or developing new
ones in radio, sound recording, electronic, and
allied fields, desires opportunity with progres-
sive organization. Age 36. PW-279, Electronics,
330 W. 42nd St., New York, N. Y.

DEPENDABLE

Used

ELECTRONIC TUBE EQUIPMENT

Complete line of used equipment for the manu-
facture of Radio Tubes, Neon Tubes, Incandescent
Lamps, etc. Write for Bulletin showing 25 to 75%
savings.

CALLITE TUNGSTEN CORPORATION
formerly Eisler Electric Corp.
534 39th Street, Union City, N. J.

POSITIONS WANTED

LICENSED BROADCAST OPERATOR. Seven
years of varied radio experience. Age 26.
Desires position in development and installa-
tion of frequency modulation or television
equipment. Capable of traveling. Thomas
Lemmo, 410 Seventh Street, Brooklyn, N. Y.
South 8-5196.

VACUUM TUBE ENGINEER; seven years ex-
perience with fluorescent lamps, photocells,
x-ray, cathodray, and transmitting tubes,
Mercury-vapor and grid controlled rectifiers,
and electron telescopes. B.S. degree in Elec-
trical Engineering. PW-280, Electronics, 520 N.
Michigan Ave., Chicago, Ill.

HIGH GRADE USED ELECTRON TUBE MACHINERY

Huge Stock of Every Type and Variety

KAHLE ENGINEERING CORPORATION
Specialists in Equipment for the manufacture of
Neon Tubes, Radio Tubes, Incandescent Lamps,
Photo Cells, X-ray Tubes, etc.

900 DeMott St., North Bergen, N. J.

What is YOUR Problem?

Do you need competent men for your
staff?

Are you seeking employment?

Or, are you looking for—or offering
—a business opportunity of special
interest to men in the industry served
by this publication?

The solution of any of these prob-
lems can logically be found first
among other readers of Electronics.
You can get their attention—at small
cost—through an advertisement here.

INDEX TO ADVERTISERS

A

Aerovox Corp.	97
American Gas Accumulator Co.	74
American Lava Corp.	5
American Platinum Works	82
American Transformer Co.	12
Anaconda Wire & Cable Co.	53, 54, 55, 56
Astatic Microphone Laboratory, Inc.	88
Audak Co.	105
Autocall Co.	96
Automatic Electric Co.	76

B

Bakelite Corp.	Third Cover
Ballantine Laboratories, Inc.	52
Benwood Linze Co.	97
Biddle Co., James G.	87
Blaw-Knox Co.	57
Bliley Electric Co.	82
Bud Radio, Inc.	76

C

Callite Tungsten Corp.	58
Cannon Electric Development Co.	86
Capitol Radio Engineering Institute	88
Carborundum Co., Globar Div.	72
Carter Motor Co.	74
Centralab Div. Globe Union, Inc.	71
Cinadagraph Corp.	87
Cinch Manufacturing Corp.	49
Clare & Co., C. P.	85
Clarostat Mfg. Co.	88
Cohn, Sigmund	104
Cornell-Dubilier Electric Corp.	7
Cotter Thermo-Electric Co.	103
Cross, H.	103

D

Daven Co.	64
Driver Co., Wilbur B.	99
DuMont Laboratories Inc., Allen B.	93
Dunn, Inc., Struthers	14
Duotone Co., Inc.	93

E

Eicor	96
Eisler Engineering Co.	103
Eitel-McCullough, Inc.	67
Erie Resistor Corp.	17

F

Ferranti Electric, Inc.	95
Formica Insulation Co.	81

G

Galvin Mfg. Corp.	6
Gates American Corp.	106
General Electric Co.	8, 73
General Test Equipment Co.	103
Goat Metal Stampings, Inc.	99
Guardian Electric Mfg. Co.	68

H

Hallicrafters, Inc.	87
Harvey Radio Co.	103
Hewlett-Packard Co.	50
Heintz & Kaufman, Ltd.	15
Hipower Crystal Co.	103
Hunter Pressed Steel Co.	90
Hygrade Sylvania Corp.	51

I

Instrument Resistors, Inc.	78
International Resistance Co.	59
Irvington Varnish & Insulator Co.	66
Isolantite, Inc.	65

J

Jackson Electrical Instrument Co.	93
Johnson Co., E. F.	78
Jones, Howard B.	74

K

Kenyon Transformer Co.	98
Keuffel & Esser Co.	3

L

Lapp Insulator Co.	13
Lingo & Son, Inc., John E.	75
Littelfuse, Inc.	80

M

Magnetic Windings Co.	91
Mallory & Co., P. R.	18
McGraw-Hill Book Co.	102
Mico Instrument Co.	97
Millen Mfg. Co., Inc., James	91
Monsanto Chemical Co.	2

O

Ohmite Mfg. Co.	91
Onan & Sons, D. W.	80

P

Paramount Products Co.	95
Parker-Kalon Corp.	4
Pioneer Gen-E-Motor Corp.	84
Precision Apparatus Co.	90
Presto Recording Corp.	63

R

Rauland Corp.	88
Raytheon Mfg. Co.	85
RCA Manufacturing Co.	77, Fourth Cover
Rex Rheostat Co.	103
Richardson Co.	86

S

Shallcross Mfg. Co.	102
Signal Indicator Corp.	103
Simpson Electric Co.	80
Sola Electric Co.	89
Solar Mfg. Co.	60
Stackpole Carbon Co.	70
Standard Pressed Steel Co.	86
Superior Tube Co.	16
Synthane Corp.	9, 10

T

Taylor Fibre Co.	99
Terminal Radio Corp.	103
Thomas & Skinner Steel Pds. Co.	78
Triplett Electrical Instrument Co.	96

U

Union Carbide & Carbon Corp.	Third Cover
United Electronics Co.	61
United Transformer Corp.	Second Cover
University Laboratories	103

W

Ward Leonard Electric Co.	62
Western Electric Co.	11, 72
Weston Electrical Instrument Corp.	79
White Dental Mfg. Co., S. S.	92
Wilson Co., H. A.	92

Professional Services 98

SEARCHLIGHT SECTION
(Classified Advertising)

EMPLOYMENT 104
USED EQUIPMENT FOR SALE

Callite Tungsten Corp.	104
Kahle Engineering Corp.	104



AUDAX

"RELAYED-FLUX" Microdyne

*repeatedly convinces the most skeptical
after an actual trial-by-ear*

Talk is cheap and anyone can make broad, sweeping statements regarding any pick-up . . . but the significant difference about AUDAX Moving-Inductor reproducers is that they never fail to convert the hard-to-convert when put to the only test that matters . . . the EAR test.

- Flat within $\pm 1\frac{1}{2}$ db to over 10,000 cycles
- Vibratory momentum extremely low
- Absence of distortion
- High stylus compliance
- Low Point-pressure
- Complete with special arm

With or without Jewel Point, MICRODYNE delivers sharp, clean-cut *fac simile* reproduction in all climatic conditions . . . its day-in and day-out uniformity is a marvel to all who have tried it . . . even to skeptics who used some other type before they tried Microdyne.

**"The Standard by Which Others
Are Judged and Valued"**

Pickup List Prices
\$12.50 to \$188.00

HIGH FIDELITY CUTTERS
List to \$98.00

WITH OUR COMPLIMENTS
A copy of "PICK-UP-FACTS" is yours for the asking. It answers many questions concerning record reproduction.

AUDAK COMPANY
500 Fifth Avenue New York City

*"Creators of High Grade Electrical
and Acoustical Apparatus Since 1915"*

by LAND or by SEA...

Your "Mainline" from Desk to Field!

— at SEA

— at PLANT

— in the FIELD

— at the SCENE

— on LOCATION

For all types of Point-to-point Communication
GATES C-40 TRANSMITTERS

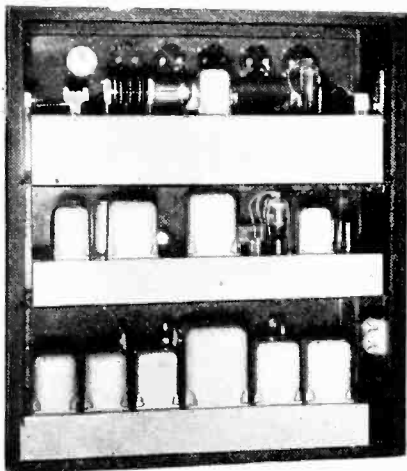

Note the 3-deck construction. It has a maximum power of 100 watts 100% high level modulated. Any one of five frequencies may be selected by a single control. It is supplied with a standard cradle-type hand set ready to attach to any communications receiver. There are two main power supplies—one for the R. F. and one for the modulators. It is completely relayed, including time delay, pilot and antenna change-over provisions with push to talk.

Use this 100-watt versatile Transmitter for a dozen different purposes and it will meet every requirement for fool-proof, point-to-point communication services.

If distance and accessibility are a barrier, and conversation important to your routine, this Gates C-40 is an economical investment whether it be for ship-to-shore, point-to-point or stand-by service. It is extremely compact and convenient in size to fit snugly in a sedan, delivery truck, the pilot house of a tug or steamer, in an office or in any small space installation.

This popular unit embodies all the new and valuable features that Gates' experience and reputation have provided. Controls are simplified to save time and increase efficiency. It is streamlined in design. Yes, the C-40 Transmitter is built for tough rugged service—it is your best buy! *We suggest you write today for complete description in Catalog Bulletin AM-1.*

GATES
 QUINCY, ILLINOIS, U.S.A.

AMERICAN CORPORATION

FM-AM Tuner

A COMBINATION FM-AM TUNER for use with existing audio equipment is offered by Hallicrafters, 4611 South Indiana Ave., Chicago. It has an undistorted output of 130 milliwatts, which is ample for any standard amplifier, including those in existing broadcast receivers. This tuner, Model S-31, provides a dual i-f system, 4.3 megacycles for frequency modulation and 455 kilocycles for amplitude modulation. A 6SK7 t-r-f stage and a 6SA7 converter provide the r-f input to both



channels. The f-m channel makes use of a 6SJ7 limiter, 6AB7 and 6AC7 i-f tubes and a 6H6 discriminator. The a-m channel uses a single 6SK7 with a special band-pass input circuit. A 6SR7 serves as a detector and a-v-c tube for amplitude modulation and its triode section as the output stage for both a-m and f-m channels, as well as for phonograph. Output impedances of 500 and 5000 ohms are provided plus a headphone jack for monitoring purposes. The panel is the standard rack-mounting type 19x8 $\frac{1}{2}$ inches and is suitable for rack or cabinet mounting.

Broadcast Signal Generator and Station Finder

A PORTABLE SIGNAL generator adapted for rough uses, battery-operated, and covering the broadcast bands is announced by Radex Corporation, 1733 Milwaukee Avenue, Chicago, Ill. It



weighs 4 $\frac{1}{2}$ pounds with batteries, is small (6 $\frac{1}{2}$ x4 $\frac{1}{2}$ inches), and has long battery life. Current drain is 50 milliamperes from the A battery and 1 milliamperes from the B battery supply.



New Brilliance in Radio Cabinet Styling achieved with combination of "BAKELITE" CAST RESIN, UREA, AND ACETATE PLASTICS

Three types of BAKELITE Plastics are combined with striking effect in cabinet and trim for the new portable receiver made by General Television and Radio Corporation. Sales appeal is enhanced considerably because the assembly gets away from the commonplace and becomes more than a "box" to house the chassis.

BAKELITE Cast Resins, in various colors such as dubonnet, ivory, and turquoise, are employed for the jewel-like cabinets. The one-piece housings are cast in inexpensive lead molds and then polished to bring out the rich

beauty and depth of color, and wear-resistant finish.

BAKELITE Urea Plastics are used for the compression-molded grille, handle, and tuning knobs because their delicate color is unaffected by constant handling and exposure to light.

BAKELITE Cellulose-Acetates provide high luster and toughness for the thin-walled bezel and pointer. These parts are injection-molded at low cost, in matching colors to complete styling requirements.

Learn more about the various types of BAKELITE Plastics and the manufac-

turing and merchandising advantages to be gained through their proper application by consulting BAKELITE Plastics Headquarters. Write also for Booklets 10H and 10M.

BAKELITE CORPORATION
Unit of Union Carbide and Carbon Corporation



30 EAST 42ND STREET, NEW YORK

BAKELITE

The word "Bakelite" and the identifying products  Symbol are registered trademarks of Bakelite Corporation

PLASTICS HEADQUARTERS

Cabinet cast by Bend-A-Lite Plastics Co. Urea molded parts (in the order they are mentioned) by Molded Products Co., Imperial Molded Products Corp., Auburn Button Works. Acetate molded parts by Chicago Die Mold Mfg. Co.

UNEXCELLED FOR TODAY'S UHF APPLICATIONS - A "MUST" FOR TOMORROW'S

RCA-815

PUSH-PULL R-F BEAM POWER AMPLIFIER

- Takes 60 watts input (CCS) to 150 Mc.
- Uses less than 1/2-watt of grid drive.
- Generally requires no neutralization.
- Takes full input with a plate voltage of only 400 volts (CCS).
- New glass-button stem structure provides short leads and low lead inductance.

NET PRICE, ONLY \$4.50

... AFTER A YEAR OF PRACTICAL FIELD SERVICE

After passing every conceivable laboratory and field test in the months since this tube was announced, RCA engineers now have given the "go ahead" signal on the RCA-815. This is consistent with the RCA policy against ever asking the customer to be the subject of experiment. Production facilities are now being expanded in an earnest effort to meet the great demand for this spectacular tube.

Compact, inexpensive and providing push-pull beam power within one tube envelope, the RCA-815 will deliver an output of over 40 watts (class C telegraphy) on all frequencies up to 150 Mc. It requires a plate voltage of only 400 to 500 volts, needs less than one-half watt of grid drive and generally requires no neutralization on any frequency.

Operated at frequencies as high as 150 Mc, a single RCA-815 in push-pull class C telegraph service at CCS Ratings is capable of handling 60 watts with only 0.23 watt of driving power. It operates satisfactorily at reduced input up to 225 Mc. Total maximum plate dissipation is 20 watts.

A new glass button-type stem structure permits compactness of design best illustrated by the tube's overall length of only 4 9/16". The 815 has excellent shielding, close electrode spacing and short leads with consequent assurance of low lead inductance. The large-wafer octal type base with metal-shell has low-loss "Micanol" insulation.

While providing greater efficiency and economy for present day applications, the RCA-815 also is of particular interest to the engineer who buys today with an eye to the more exacting UHF requirements of tomorrow. Ask your RCA Tube and Equipment Distributor for the bulletin on this tube, or write direct to the Commercial Engineering Section, RCA Manufacturing Co., Inc., Harrison, N. J.

Maximum Ratings for class C telegraph service (All values are for both units)

	CCS	ICAS		CCS	ICAS
D-C PLATE VOLTAGE	400	500 Volts	D-C GRID CURRENT	6	6 Ma.
D-C SCREEN VOLTAGE	200	200 Volts	PLATE INPUT	60	75 Watts
D-C PLATE CURRENT	150	150 Ma.	SCREEN INPUT	4	4 Watts
PLATE DISSIPATION	20 Watts CCS			25 Watts ICAS	



Transmitting Tubes

PROVED IN COMMUNICATION'S MOST EXACTING APPLICATIONS

RCA MANUFACTURING CO., INC., CAMDEN, N. J. • A Service of The Radio Corporation of America
In Canada: RCA-VICTOR COMPANY LIMITED, MONTREAL

150-Mc R-F POWER AMPLIFIER Illustrating a Typical Application of the new RCA-815

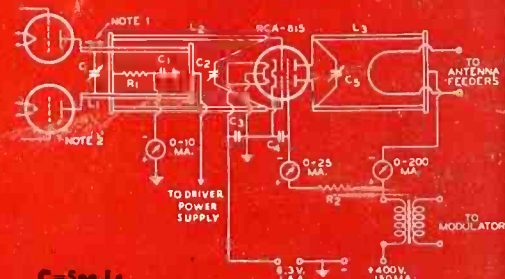

- C-See L1
- C1C2C3-1" x 1 1/2" copper sheet insulated from chassis by mica sheet 0.002" thick, or 0.0005-μ "postage stamp" mica condensers soldered to chassis with shortest practicable leads.
- C4C5-Copper discs, 1/2" x 1 1/2".
- R1-15000 ohms, 0.5 watt.
- R2-15000 ohms, 25-watt, adjustable.
- L1=1/2" dia. copper tubing. Length of tubing and capacitance of C depend upon driver tube employed.
- L2=1/2" dia. copper tubing, 12 1/2" long, and spaced approx. 1/8" between centers.
- L3=1/2" dia. copper tubing, 13" long and spaced approx. 1/8" between centers.

NOTES

- (1) The r-f driver stage should be able to deliver about one watt of useful r-f power, to insure ample grid excitation for the 815.
- (2) Adjust coupling between L1 and L2 on tuning of C and C2 for recommended d-c grid current of the 815.
- (3) L1 and L2 should be effectively shielded from L3 by a metal chassis, or by a vertical metal baffle plate used to mount the 815.
- (4) Adjust coupling of "hairpin" antenna coil to L3 so that the amplifier is properly loaded.
- (5) A small lumped inductance can be substituted for the amplifier grid lines, if desired. Such a grid coil is preferably tuned by varying its inductance, rather than by means of a variable condenser.